

**LED Series Hot Tub Owner's Manual**  
**J-315™, J-325™, J-335™, J-345™,**  
**J-355™, J-365™ Models**

2530-398, Rev. C

**230 VAC, 3-Wire Connection**

USE COPPER CONDUCTORS ONLY. WIRE SIZE MUST BE APPROPRIATE PER NEC AND/OR LOCAL CODES.

# Attention New Spa Owner!

Congratulations on the purchase of your new Jacuzzi® spa! The following is a list of automated functions performed by your spa. These functions are listed below in an attempt to suppress any operational concerns you may have during the first 24-hours of ownership! Also listed below are important maintenance recommendations you should observe on a regular basis to protect your new investment.

## Automated Operations

Approximately two minutes after power is applied to the spa, the first filtration/heating cycle turns on pump 1. In J-335, J-345, J-355 and J-365 models, an automatic five minute “blow-out” function also activates pump 2 for a period of five minutes to flush all lines. Then, after five minutes, pump 2 turns off and pump 1 continues to operate for the duration of the cycle. *Note: this function only occurs during the first filtration/heating cycle each day.*

## Maintain Healthy Spa Water

Always maintain your spa's water chemistry within the following parameters as defined by the Association of Pool And Spa Professionals/USA:

pH	7.4-7.6
Free Chlorine	3.0-4.0 ppm
Free Bromine	2.0-4.0 ppm
Total Alkalinity	100-120 ppm
Calcium Hardness	150-250 ppm

Always maintain your spas filter as outlined below to ensure healthy spa water. Refer to page 33 “Water Quality Maintenance” for additional information.

## Required Filter Maintenance

Your new spa is equipped with an advanced water filtration system that provides unsurpassed water quality! To ensure maximum water quality at all times, you should clean the filter cartridge every three months, or earlier as necessary. See page 27-28 for detailed filter cartridge cleaning/replacement instructions.

## Required Water Replacement

You should replace the spa's water every 3 months. The frequency depends on a number of variables including frequency of use, number of users, and attention paid to water quality maintenance. You will know it is time for a change when you cannot control sudsing and/or you can no longer get the normal feel or sparkle to the water, even though the key water balance measurements are all within the proper parameters. See page 33 for additional information.



## Table of Contents

<b>1.0</b>	<b>Important Spa Owner Information .....</b>	<b>1</b>
<b>2.0</b>	<b>Important Safety Instructions.....</b>	<b>2</b>
<b>3.0</b>	<b>Choosing A Location.....</b>	<b>6</b>
3.1	Outdoor Location .....	7
3.2	Indoor Location .....	7
<b>4.0</b>	<b>General Electrical Safety Instructions.....</b>	<b>9</b>
<b>5.0</b>	<b>Power Requirements.....</b>	<b>10</b>
<b>6.0</b>	<b>Electrical Wiring Instructions.....</b>	<b>12</b>
<b>7.0</b>	<b>Spa Fill Up Procedure .....</b>	<b>14</b>
<b>8.0</b>	<b>Control Functions.....</b>	<b>18</b>
8.1	Control Panel.....	18
8.2	Spa Features And Controls .....	20
<b>9.0</b>	<b>Operating Instructions .....</b>	<b>21</b>
9.1	Setting Water Temperature.....	21
9.2	Activate Pumps.....	21
9.3	Light Operation (J-315/J-325 Models).....	22
9.4	Light On/Off Button (J-335/J-345/J-355/J-365 Models)..	23
9.5	Light Mode Button (J-335/J-345/J-355/J-365 Models) ...	23
9.6	Selecting Desired Massage Action .....	24
9.7	Adjusting Individual Jet Flow .....	24
9.8	Adjusting PowerPro Jets .....	24
9.9	Waterfall Feature .....	24
9.10	Air Controls.....	25
9.11	Optional Jacuzzi Audio System .....	25
<b>10.0</b>	<b>Automatic Filtration Cycles .....</b>	<b>25</b>
10.1	Standard Filtration/Heating Modes.....	25
10.2	Economy Filtration/Heating Modes.....	25
10.3	Lock Modes .....	26
10.4	Selecting The Filtration/Heating Mode .....	26
<b>11.0</b>	<b>Spa Maintenance .....</b>	<b>27</b>
11.1	Cleaning The Filters .....	27
11.2	Draining And Refilling.....	29
11.3	Cleaning The Spa Interior.....	30



11.4	Pillow Care .....	31
11.5	Maintaining The Cover .....	31
11.6	Maintaining The Synthetic Cabinet.....	31
11.7	Winterizing .....	32
11.8	Restarting Your Spa in Cold Weather .....	32
<b>12.0</b>	<b>Water Quality Maintenance.....</b>	<b>33</b>
12.1	pH Control .....	33
12.2	Sanitizing .....	33
12.3	Optional CD Ozone Water Maintenance System .....	34
<b>13.0</b>	<b>Error Conditions/Error Messages .....</b>	<b>34</b>
13.1	Summer Logic .....	34
13.2	Overheat Condition.....	35
13.3	Panel Displays SN1.....	35
13.4	Panel Displays SN2.....	35
13.5	Panel Displays FL1 or FL2.....	35
13.6	Panel Displays COL .....	36
13.7	Panel Displays ICE.....	36
13.8	Panel Displays - - - .....	36
<b>14.0</b>	<b>Troubleshooting Procedures.....</b>	<b>36</b>
14.1	None Of The Components Operate .....	37
14.2	Pump Does Not Operate but Light Does.....	37
14.3	Poor Jet Action .....	37
14.4	Water Is Too Hot.....	38
14.5	No Heat .....	38
<b>15.0</b>	<b>J-315 Convertible Circuit Diagram (60Hz).....</b>	<b>39</b>
<b>16.0</b>	<b>J-325/J-335/J-345/J-355/J-365 Circuit Diagram (60Hz) .....</b>	<b>40</b>
<b>17.0</b>	<b>J-315 Export Circuit Diagram (50Hz) .....</b>	<b>41</b>
<b>18.0</b>	<b>J-325/J-335/J-345/J-355/J-365 Circuit Diagram (50Hz) .....</b>	<b>42</b>
<b>19.0</b>	<b>Optional Stereo Receiver Functions .....</b>	<b>43</b>
19.1	Audio System Remote Control Functions .....	50
19.2	External MP3 Player Connection .....	51



## 1.0 Important Spa Owner Information

Your Jacuzzi® spa is constructed to the highest standards and is capable of providing many years of trouble-free use. However, because heat retentive materials are utilized to insulate the spa for efficient operation, an uncovered spa surface and wall fittings directly exposed to sunlight and high temperatures for an extended period is subject to permanent damage or discoloration. Damage caused by exposing the spa to this abuse is not covered by warranty. We recommend that you always keep the spa full of water when it is exposed to direct sunlight and that you keep the Jacuzzi insulating cover in place at all times when the spa is not in use. Read and carefully follow the requirements for your spa's support base found in the section 3.0 titled, "Choosing A Location" (page 6) or as prescribed by your authorized Jacuzzi dealer.

**Jacuzzi spas constantly strives to offer the finest spas available, therefore, modifications and enhancements may be made which affect the specifications, illustrations and/or instructions contained herein.**

### FCC Notice

This equipment has been tested and found to comply with the limits for a Class B Digital Device, pursuant to Part 15 of the FCC Rules. These limits are designed to provide reasonable protection against harmful interference in a residential installation. This equipment generates, uses and can radiate radio frequency energy and, if not installed and used in accordance with the instructions, may cause harmful interference to radio communications. However, there is no guarantee that interference will not occur in a particular installation. If this equipment does cause harmful interference to radio or television reception, which can be determined by turning the equipment off and on, the user is encouraged to try to correct the interference by one or more of the following measures:

1. Rearrange or relocate the receiving antenna;
2. Increase the separation between the equipment and receiver;
3. Connect the equipment into an outlet on a circuit different from the circuit connected;
4. Consult the dealer or an experienced radio/TV technician for help. (Changes or modifications not expressly approved by the party responsible for FCC compliance could void the user's authority to operate this equipment.)



## 2.0 IMPORTANT SAFETY INSTRUCTIONS

### READ AND FOLLOW ALL INSTRUCTIONS CAREFULLY

When installing and using this electrical equipment, basic safety precautions should always be followed, including:

1. **WARNING:** To reduce the risk of injury, do not permit children to use this product unless they are closely supervised at all times.
2. **WARNING:** A grounding wire connector is provided on this unit to connect a minimum No. 8 AWG (8.4mm<sup>2</sup>) solid copper conductor between this unit and any metal equipment, metal enclosures of electrical equipment, metal water pipe, or conduit within 5 feet (1.5m) of the unit.
3. **DANGER:** Risk of Accidental Drowning. Extreme caution must be exercised to prevent unauthorized access by children. To avoid accidents, ensure that children cannot use this spa unless they are supervised at all times.
4. **DANGER:** Risk of Injury. The suction fittings in this spa are sized to match the specific water flow created by the pump. Should the need arise to replace the suction fittings or the pump, be sure that the flow rates are compatible. Never operate the spa if the suction fittings are broken or missing. Never replace a suction fitting with one rated less than the flow rate marked on the original suction fitting.
5. **DANGER:** Risk of Electric Shock. Install at least 5 feet (1.5m), from all metal surfaces. As an alternative, a spa may be installed within 5 feet of metal surfaces if each metal surface is permanently connected (bonded) by a minimum No. 8 AWG (8.4 mm<sup>2</sup>) solid copper conductor attached to the wire connector on the grounding lug, inside the equipment compartment on the equipment box.
6. **DANGER:** Risk of Electric Shock. Do not permit any electrical appliance, such as a light, telephone, radio, television, etc. within 5 feet (1.5m) of a spa unless such appliances are built-in by the manufacturer.
7. **ELECTRICAL SUPPLY:** The electrical supply for this product must include a suitably rated switch or circuit breaker to open all ungrounded supply conductors to comply with section 422-20 of the



National Electrical Code/USA, ANSI/NFPA 70. The disconnect must be readily accessible and visible to the spa occupant but installed at least 5 feet (1.5m), from the spa water.

**8. WARNING: To Reduce the Risk of Injury:**

9. The water in the spa should never exceed 104°F (40°C). Water temperatures between 100°F (38°C) and 104°F (40°C) are considered safe for a healthy adult. Lower water temperatures are recommended for young children and when spa use may exceed 10 minutes.
10. Since excessive water temperatures have a high potential for causing fetal damage during the early months of pregnancy, pregnant or possibly pregnant women should limit spa water temperatures to 100°F (38°C). If pregnant, please consult your physician before using a spa.
11. Before entering the spa, the user should measure the water temperature with an accurate thermometer since the tolerance of water temperature-regulating devices may vary as much as +/- 5°F (2°C).
12. The use of alcohol, drugs, or medication before or during spa use may lead to unconsciousness with the possibility of drowning.
13. Persons suffering from obesity or a medical history of heart disease, low or high blood pressure, circulatory system problems, diabetes, infectious diseases or immune deficiency syndromes should consult a physician before using a spa. If you experience breathing difficulties in association with using or operating your spa, discontinue use and consult your physician.
14. Persons using medication should consult a physician before using a spa since some medication may induce drowsiness, while other medication may affect heart rate, blood pressure, and circulation.
15. Always shower before and after using your spa. To reduce the possibility of contracting a waterborne illness, always maintain water chemistry within the parameters listed on the inside cover of this manual. If you or other bathers experience such a condition, discontinue use and seek medical attention.

**IMPORTANT CSA SAFETY INSTRUCTIONS (CANADA ONLY)**

When using this electrical equipment, basic safety precautions should always be followed, including the following:

1. READ AND FOLLOW ALL INSTRUCTIONS.
2. A green colored terminal or a terminal marked G, Gr, Ground, Grounding or the ⊕ symbol\* is located inside the supply terminal box or compartment. To reduce the risk of electric shock, this terminal must be connected to the grounding means provided in the electric supply service panel with a continuous copper wire equivalent in size to the circuit conductors that supply this equipment.

\*IEC Publication 417, Symbol 5019.

3. At least two lugs marked “Bonding Lugs” are provided on the external surface or on the inside of the supply terminal box/compartment. To reduce the risk of electric shock, connect the local common bonding grid in the area of the spa to these terminals with an insulated or bare copper conductor not smaller than No. 6 AWG.
4. All field installed metal components such as rails, ladders, drains or other similar hardware within 10 feet (3m) of the spa shall be bonded to the equipment grounding buss with copper conductors not smaller than No. 6 AWG.

**5. SAVE THESE INSTRUCTIONS.**

**WARNING:** Children should not use spas without adult supervision.

**WARNING:** Do not use spas unless all suction guards are installed to prevent body and hair entrapment.

**WARNING:** People with infectious diseases should not use a spa.

**WARNING:** To avoid injury, exercise care when entering or exiting the spa.

**WARNING:** Do not use drugs or alcohol before or during the use of a spa to avoid unconsciousness and possible drowning.

**WARNING:** Pregnant or possibly pregnant women should consult a physician before using a spa.





**WARNING:** Water temperature in excess of 40°C (104°F) may be injurious to your health.

**WARNING:** Before entering the spa, measure the water temperature with an accurate thermometer.

**WARNING:** Do not use a spa immediately following strenuous exercise.

**WARNING:** Prolonged immersion in a spa may be injurious to your health.

**WARNING:** Do not permit electric appliances (such as lights, telephone, radio, television, etc.) within 5 feet (1.5m) of this spa unless such appliances are built-in by the manufacturer.

**CAUTION:** Maintain water chemistry in accordance with manufacturer's instructions.

**WARNING:** The use of alcohol or drugs can greatly increase the risk of fatal hyperthermia in spas.

## **SAVE THESE INSTRUCTIONS**

### **HYPERTHERMIA**

Prolonged immersion in hot water may induce hyperthermia. A description of the causes, symptoms, and effects of hyperthermia are as follows:

Hyperthermia occurs when the internal temperature of the body reaches a level several degrees above the normal body temperature of 98.6°F (37°C). The symptoms of hyperthermia include drowsiness, lethargy, and an increase in the internal temperature of the body. The effects of hyperthermia include:

1. Unawareness of impending hazard;
2. Failure to perceive heat;
3. Failure to recognize the need to exit spa;
4. Physical inability to exit spa;
5. Fetal damage in pregnant women; and
6. Unconsciousness and danger of drowning.



**A warning sign is provided in your warranty packet. Please install it at a location near your spa, where it is visible to the user of the spa. For additional or replacement signs please contact your local Jacuzzi dealer and reference item number #6530-082.**

## **CAUTIONS**

1. Persons suffering from heart disease, diabetes, high or low blood pressure, and any condition requiring medical treatment, pregnant women, the elderly, or infants should consult with a physician before using a spa.
2. The Consumer Products Safety Commission/USA has stated that the water temperature in a spa should not exceed 104°F (40°C). Immersion in water in excess of 104°F (40°C) can be hazardous to your health.
3. Observe a reasonable time limit when using the spa. Long exposures at higher temperatures can cause high body temperature. Symptoms may include dizziness, nausea, fainting, drowsiness, and reduced awareness. These effects could possibly result in drowning.
4. Do not use the spa under the influence of alcohol, narcotics, or other drugs. Use of the spa under these conditions may lead to serious consequences.
5. Always test the spa water temperature before entering the spa. Enter and exit the spa slowly. Wet surfaces can be very slippery.
6. Never bring any electrical appliances into or near the spa. Never operate any electrical appliances from inside the spa or when you are wet unless such appliances are built-in by the manufacturer.
7. Proper chemical maintenance of spa water is necessary to maintain safe water and prevent possible damage to spa components.
8. Use the straps and clip tie downs to secure the cover when not in use. This will help to discourage unsupervised children from entering the spa and keep the spa cover secure in high-wind conditions. There is no representation that the cover, clip tie-downs, or actual locks will prevent access to the spa.

## **3.0 Choosing A Location**

**IMPORTANT:** Because of the combined weight of the spa, water and users, it is extremely important that the base upon which the spa rests be smooth, flat, level and capable of uniformly supporting this weight, without shifting or settling, for the entire time the spa is in place. If the



spa is placed on a surface which does not meet these requirements, damage to the skirt and/or the spa shell may result. Damage caused by improper support is not covered under warranty. It is the responsibility of the spa owner to assure the integrity of the support at all times. We recommend a poured, reinforced concrete slab with a minimum thickness of 4 inches (10cm). Wood decking is also acceptable provided it is constructed so that it meets the requirements outlined above.

The spa must be installed in such a manner as to provide drainage away from it. Placing the spa in a depression without provisions for proper drainage could allow rain, overflow and other casual water to flood the equipment and create a wet condition in which it would sit in. For spas which will be recessed into a floor or deck, install so as to permit access to the equipment, either from above or below, for servicing. Make certain that there are no obstructions which would prevent removal of all side cabinet side panels and access to the jet components, especially on the side with the equipment bay.

### 3.1 Outdoor Location

In selecting the ideal outdoor location for your spa, we suggest that you take into consideration:

1. The proximity to changing area and shelter (especially in colder weather).
2. The pathway to and from your spa (this should be free of debris so that dirt and leaves are not easily tracked into the spa).
3. The closeness to trees and shrubbery (remember that leaves and birds could create extra work in keeping the spa clean).
4. A sheltered environment (less wind and weather exposure can result in lowered operation and maintenance costs).
5. The overall enhancement of your environment. It is preferable not to place the spa under an unguttered roof overhang since run-off water will shorten the life expectancy of the spa cover.

### 3.2 Indoor Location

For indoor installations many factors need to be considered before installing a spa indoors.

- **Proper Foundation:** Consult a Structural Engineer when considering a foundation that will adequately support the spa the entire time it is in place. Proper support is critical especially if the spa is to rest on a second story or higher. For spas that are to rest on balconies,



roofs or other platforms not specifically tied into the main structural support, you should consult a professional Structural Engineer with experience in this type of application.

- **Proper Drainage:** It is extremely important to have in place measures to sufficiently handle excessive water spillage. Be sure the flooring in which the spa rests on has adequate drainage and can handle the entire contents of the spa. Be sure to make provisions for ceilings and other structures that may be below the spas installation. Areas around your spa can become wet or moist so all flooring and subsequent furniture, walls and adjacent structures should be able to withstand or resist water and moisture.
- **Proper Ventilation:** Proper ventilation should be discussed with an Engineer or authority competent enough to understand the necessary provisions needed to vent moist or heated air and air associated with chemical odors outdoors. When the spa is in use considerable amounts of moisture will escape, potentially causing mold and mildew over time which can damage certain surfaces and/or surroundings.
- **Sufficient Access:** In the unlikely event that you should ever need to access or gain entry to any portion of the spa for servicing, it is highly recommended that you plan your indoor installation to provide full access to the entire spa.
- **Warranty:** Damage caused by not following these guidelines or any improper installation not in accordance to local codes or authorities is not covered under the spas warranty. Please consult your local state or city building ordinances.



**WARNING:** In addition to maintenance of filters and water chemistry, proper ventilation is recommended to reduce the risk of exposure to viruses and bacteria that could be present in the air or water. Consult a licensed architect or building contractor to determine your specific needs if installing your spa indoors.



## 4.0 General Electrical Safety Instructions

Your new Jacuzzi® spa is equipped with a “state-of-the-art” equipment system. It contains the most advanced safety and self-protective equipment in the industry. Nonetheless, this spa must be installed properly to insure dependable usage. Please contact your dealer or local building department should you have any questions regarding your installation.

Proper grounding is extremely important. Jacuzzi spas are equipped with a current collector system. A pressure wire connector is provided on the surface of the control box, located outside the equipment door (Figure-B, page 13) to permit connection of a bonding wire between this point and any ground metal equipment, metal water pipe or conduit within 5 feet (1.5m) of the spa, or copper clad grounding rod buried within 5 feet (1.5m) of the spa. Bonding wire must be at least No. 8 AWG (8.4mm<sup>2</sup>) solid copper wire. This is a most important safety assurance feature. Before installing this spa, check with the local building department to insure installation conforms to local building codes.

### 120/240 Volt J-315 Convertible Models

A spa connected to a 120 VAC electrical service must be located close enough to a grounded, grounding-type electrical outlet so that the included power cord can be plugged directly into it. DO NOT USE AN EXTENSION CORD as this could cause damage to the spa's equipment due to insufficient voltage. The power supplied to this spa must be a dedicated circuit with no other appliances or lights sharing the power provided by the circuit.



## 5.0 Power Requirements

Jacuzzi® spas are designed to provide optimum performance and flexibility of use when connected to the maximum electrical service listed in the tables below. If you prefer, your qualified technician can perform a minor circuit board modification that allows the hot tub to operate on a different electrical service (see table footnotes below).

### US/Canada J-315 1-Pump Convertible Models (60Hz)

	<u>120V/15A*</u>	<u>240V/30A*</u>	<u>240V/40A**</u>
Voltage:	120 VAC	240 VAC	240 VAC
# of Wires:	(15A GFCI Cord, US Only)	4 (Hard Wired Only)	4 (Hard Wired Only)
Frequency:	60Hz	60Hz	60Hz
Current Draw:	12A	21A	30A
Circuit Breaker:	15A, 1-Pole	30A, 2-Pole	40A, 2-Pole

**For 240 VAC Heater Operation:** Move the red wire on the main terminal strip (TB1) from position #1 to position #3. Make certain wires are connected exactly as shown in Figure-D (page 14) before applying power. Failure to do so will result in damage to the circuit board and/or related components and void the manufacturer's warranty.

- \* In the 15A and 30A configuration, the heater **will not operate** at the same time as the high-speed jets pump. **The factory setting is 120V/15A.** Note: **All Canadian spas must be hard wired (120 VAC or 240 VAC) per CSA Canadian standards see page 4 for details.**
- \*\* If the spa is to be operated on 40A service, remove the jumper JP1 #1-2 on the circuit board to allow the heater to operate at the same time as the high-speed jets pump (page 39).

### US/Canada J-325 1-Pump Models (60Hz)

	<u>240V/40A*</u>	<u>240V/50A**</u>
Voltage:	240 VAC	240 VAC
# of Wires:	3	3
Frequency:	60Hz	60Hz
Current Draw:	26A	36A
Circuit Breaker:	40A, 2-Pole	50A, 2-Pole

- \* In the 40A configuration, the heater **will not operate** at the same time as the high-speed jets pump.
- \*\* In the 50A configuration, the heater **will operate** at the same time as the high-speed jets pump. **This is the factory setting.**

**US/Canada J-335/J-345/J-355/J-365 2-Pump Models (60Hz)**

	<u>240V/40A*</u>	<u>240V/50A**</u>	<u>240V/60A***</u>
Voltage:	240 VAC	240 VAC	240 VAC
# of Wires:	3	3	3
Frequency:	60Hz	60Hz	60Hz
Current Draw:	26A	36A	45A
Circuit Breaker:	40A, 2-Pole	50A, 2-Pole	60A, 2-Pole

- \* In 40A configuration, the heater **will not operate** while either jets pump is running in high speed. *Note: pump 2 runs only in high speed.*
- \*\* In 50A configuration, the heater **will not operate** while both jets pumps are running in high speed. *Note: pump 2 runs only in high speed. **This is the factory setting.***
- \*\*\* In 60A configuration, the heater **will operate** while both jets pumps are running in high speed. *Note: pump 2 runs only in high speed.*

**Export J-315/J-325 1-Pump Models (50Hz)**

	<u>230V/20A*</u>	<u>230V/30A**</u>
Voltage:	230 VAC	230 VAC
# of Wires:	3	3
Frequency:	50Hz	50Hz
Current Draw:	15A	23A
Circuit Breaker:	20A	30A

- \* In 20A configuration, the heater **will not operate** at the same time as the main jets pump. **This is the factory setting.**
- \*\* In 30A configuration, the heater **will operate** at the same time as the main jets pump.

**Export J-335/J-345/J-355/J-365 2-Pump Models (50Hz)**

	<u>230V/20A*</u>	<u>230V/30A**</u>	<u>230V/40A***</u>
Voltage:	230 VAC	230 VAC	230 VAC
# of Wires:	3	3	3
Frequency:	50Hz	50Hz	50Hz
Current Draw:	15A	23A	29A
Circuit Breaker:	20A	30A	40A

- \* In 20A configuration, the heater **will not operate** while either jets pump is running in high speed. **This is the factory setting.** *Note: jets pump 2 runs only in high speed.*
- \*\* In 30A configuration, the heater **will not operate** while both jets pumps are running in high speed. *Note: pump 2 runs only in high speed.*
- \*\*\* In 40A configuration, the heater **will operate** while either jets pump is running in high speed. *Note: Jets pump 2 runs only in high speed.*



## 6.0 Electrical Wiring Instructions



**IMPORTANT NOTICE:** The electrical wiring of this spa must meet the requirements of the National Electrical Code/USA (NEC) and any applicable state or local codes. The electrical circuit must be installed by a qualified electrician and approved by a local building/electrical inspection authority.

1. **Convertible J-315 120/240V 60Hz Power Models**
- A. **120V “Plug-in” Operation:** This spa must operate on the supplied 120V GFCI cord at its original length or must be hard-wired for longer runs. **Never use an extension cord for any reason!**
- B. **Convertible 120/240V Operation:** The included 120V GFCI cord must be discarded for 240V operation. This spa must be hard-wired. Supplying power to either configuration above which is not in accordance with these instructions will void both the independent testing agency listing and the manufacturer’s warranty.
2. **Dedicated 230-240V Power Models:** This spa must be permanently connected (hard-wired) to the power supply. **No plug-in connections or extension cords are to be used in conjunction with the operation of this spa.** Supplying power to the spa which is not in accordance with these instructions will void both the independent testing agency listing and the manufacturer’s warranty.
3. The power supplied to this spa *must* be a *dedicated* circuit with no other appliances or lights sharing the power provided by the circuit.
4. To determine the current, voltage and wire size required, refer to section 5.0 “Power Requirements” (page 10-11).
  - Wire size must be appropriate per NEC/USA and/or local codes.
  - We recommend type THHN wire.
  - All wiring must be copper to ensure proper connections. **Do not use aluminum wire.**
  - When using wire larger than #6 (10mm<sup>2</sup>), add a junction box near the spa and reduce to short lengths of #8 (8.4mm<sup>2</sup>) wire to connect to the spa.
5. The electrical supply for this product must include a suitably rated switch or circuit breaker to open all ungrounded supply conductors to comply with Section 422-20 of the National Electrical Code/USA, ANSI/NFPA 70. The disconnecting means must be readily accessible to the spa’s occupant but installed at least 5 feet (1.5m) from spa water.
6. The electrical circuit supplied for the spa must include a suitable ground fault circuit interrupter (GFCI) as required by NEC/USA



## Article 680-42.

7. To gain access to the spa's power terminal block, remove the screws securing the cabinet panel on the side of the spa under the control panel (Figure-A). Then remove the four control box door screws and door (Figure-B).
8. Select the power supply inlet you want to use (Figure-A). Feed power cable to control box, then install it through the large opening provided in the bottom side of the box.
9. Connect wires, color to color, on terminal blocks TB1 and TB3 (Figure C-F, page 14). TIGHTEN SECURELY! All wires must be hooked up securely or damage could result.
10. Install control box door and screws and reinstall the cabinet side panels.

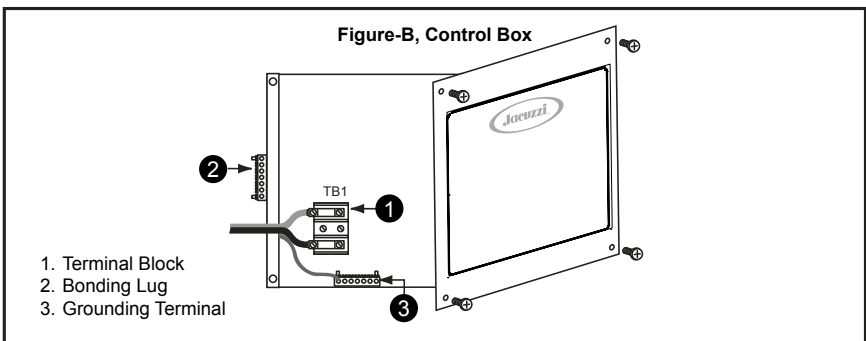
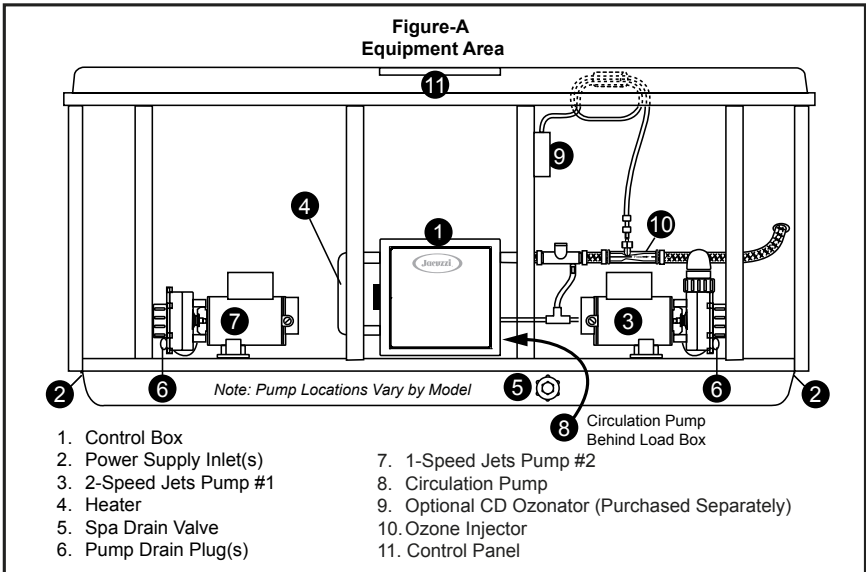

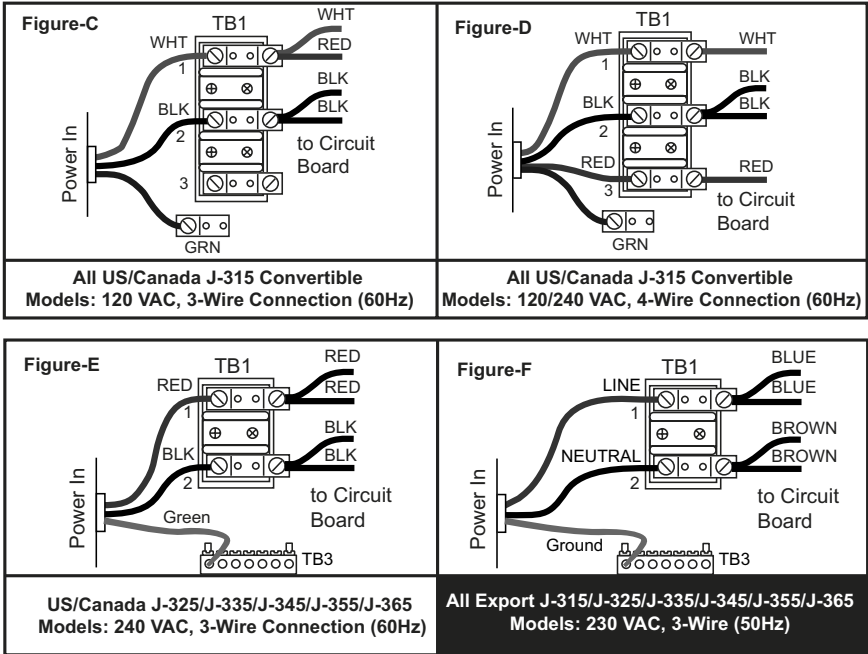

## 7.0 Spa Fill Up Procedure

FOR BEST RESULTS, read each step in its entirety before proceeding with that step:

### 1. Prepare The Spa For Filling

- Clear all debris from the spa. (Although the spa shell has been polished at the factory, you may want to treat it with a specially formulated spa cleaner. Consult your authorized Jacuzzi dealer for additional information prior to filling spa.
- Remove filter lid then remove filter cartridges from filter bucket.

### 2. Fill Spa

- Place the end of your garden hose into the empty filter bucket.



**CAUTION:** Never fill with water from a water softener. If your water is extremely “hard”, it is preferable to fill half-way with hard water and the rest of the way with softened water. Or, you may fill entirely with hard water if you use a special water additive available from your authorized Jacuzzi dealer.



- Fill spa until water covers all jets but does not touch the bottom of the lowest headrest. DO NOT OVERFILL.

**IMPORTANT:** Always fill your spa through the filter bucket after draining. Failure to do so may cause air to be trapped in either pump, preventing the pump from circulating water. Remove the hose and replace both filter cartridges.

### 3. Turn On Power

Turn on power to spa at the home's circuit breaker to start boot up sequence (section 9.0, page 21). The heater and filter/circulation pump automatically activate after several seconds. If the control panel LCD flashes water temperature and "COL" or "ICE" this is normal, refer to page 36 for additional information.

### 4. Activate Jets Pumps

Turn on all jet(s) pumps to ensure proper mixing when adding start-up chemical in step 5.

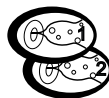

### 5. Add Start-Up Chemicals

Add the spa water chemicals as recommended by your authorized Jacuzzi dealer. See section 12.0 "Water Quality Maintenance" (page 33) for general guidance.

### 6. Establish A Stable Sanitizer Reading

Establish a stable sanitizer reading between 3.0-4.0 ppm Chlorine or 2.0-4.0 ppm Bromine. To ensure healthy water conditions, always maintain a constant sanitizer reading within the levels recommended by the Association of Pool And Spa Professionals/USA printed on the inside cover of this manual. If sanitizer levels cannot be stabilized, perform the decontamination procedure steps 9-15 on page 16-18. *Note: the "decontamination procedure" steps 9-15 should also be used after the spa has been "Winterized" (section 11.7, page 32) or has been sitting without power for an extended period.*

### 7. Set Spa To Heat

To warm spa water to a comfortable temperature, follow these steps:

- The LCD display on the control panel displays the actual temperature of the spa water. Press either the **COOLER (-)** or **WARMER (+)** button once to display the "set" temperature for 5 seconds. If you want the water to heat to a different temperature, simply press **COOLER (-)** or **WARMER (+)** within 5 seconds. The set tempera-



ture increases or decreases by one degree each time one of these buttons is pressed.

- The heater will turn off when the temperature corresponding to the thermostat setting is achieved.

### Important Heater Details:

- The maximum temperature for which the spa can be set is 104°F (40°C) and the minimum is 80°F (27°C).
- Setting the thermostat at maximum will not accelerate the heating process. This will only result in a higher ultimate temperature.
- The heater operates until the water reaches the programmed “set temperature”, then turns off. The heater will reactivate after the water cools to approximately 1.5° below the “set temperature.”

### 8. Place Cover On Spa

- Keeping the insulating cover in place anytime the spa is not in use will reduce the time required for heating, thereby minimizing operating costs.
- The time required for initial heat-up will vary depending on the starting water temperature.



**DANGER:** Risk of injury, always check water temperature carefully before entering spa!

### Decontamination Procedure (Steps 9-15)

Steps 9-15 below are only required when sanitizer levels are unstable after performing steps 1-6 above. Disregard steps 9-15 below if sanitizer levels remain stable at 3.0-4.0 ppm Chlorine or 2.0-4.0 ppm Bromine after performing steps 1-6.

9. Add 2.5 ounces of Sodium Dichlor for every 100 gallons of water. Refer to the table on page 17 for approximate water fill volume by model.



**CAUTION:** Never add Chlorine tablets (Trichlor) to your spa for any reason! This chemical may damage your spa and void the manufacturer warranty.



### Water Fill Volume by Model

Spa Model	Approximate Fill Volume
J-315.....	200 US Gallons (757 Liters)
J-325.....	320 US Gallons (1,211 Liters)
J-335.....	358 US Gallons (1,355 Liters)
J-345.....	336 US Gallons (1,272 Liters)
J-355.....	363 US Gallons (1,374 Liters)
J-365.....	374 US Gallons (1,416 Liters)

10. Leave spa cover open during this step to allow excessive chemical vapors to exit spa, protecting pillows and plastic knobs from chemical attack. If spa is indoors, open doors and windows for proper ventilation. Turn on all spa jets pumps for one hour, open all air controls, and place all massage selector knob(s) in their center “combo” position as shown (right). *Note: You will need to press the jets pump button(s) every 20 minutes since these functions have an automatic 20 minute time-out function that turns them off.*



**CAUTION:** never leave your spa unattended for any reason while the cover is open and accessible to small children and animals!

11. Turn off power to the spa at the circuit breaker, then drain tub as outlined in section 11.2 “Draining And Refilling” (page 29-30).
12. Fill spa until water covers all jets but does not touch the bottom of the lowest headrest. DO NOT OVERFILL.



**CAUTION:** Never fill with water from a water softener. If your water is extremely “hard”, it is preferable to fill half-way with hard water and the rest of the way with softened water. Or, you may fill entirely with hard water if you use a special water additive available from your authorized Jacuzzi dealer.

13. Consult your authorized Jacuzzi dealer for chemical recommendations, then add chemicals to spa water to achieve a constant sanitizer reading within the levels recommended by the Association of Pool And Spa Professionals/USA printed on the inside cover of this manual.
14. Turn on all jet(s) pumps when adding chemicals to ensure proper mixing and leave your spa cover open until the sanitizer level falls



below 4.0 ppm to protect pillows and plastic knobs from chemical attack.



**CAUTION:** Never leave your spa unattended for any reason while the cover is open and accessible to small children and animals.



**CAUTION:** To prevent the unlikely possibility of contracting a waterborne illness, maintain water chemistry within step 6 parameters. If you or other bathers experience such a condition, discontinue use and seek medical attention.

15. Establish a sanitizer reading between 3.0-4.0 ppm Chlorine or 2.0-4.0 ppm Bromine, then allow the spa to set undisturbed for 8 hours. Retest water after 8 hours to determine if sanitizer levels are stable. If sanitizer levels are stable, your spa is ready for use. To ensure healthy water conditions, always maintain a constant sanitizer reading within the levels recommended by the Association of Pool And Spa Professionals/USA printed on the inside cover of this manual. If sanitizer levels are not stable at this time, it will be necessary to repeat this procedure in its entirety (steps 1-15) until stable sanitizer readings are achieved.

## 8.0 Control Functions

### 8.1 Control Panel

- A.** LED Display: Can display current water temperature (default display), water temperature set point, selected filter/heating mode, and error messages.
- B.** **Warmer ( + ) Button:**  
Increases water temperature set point.
- C.** **Cooler ( - ) Button:**  
Decreases water temperature set point.

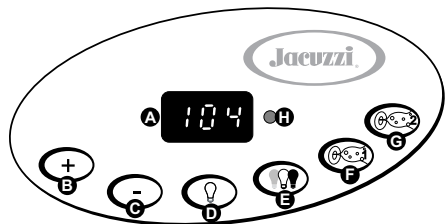

2-Pump J-335/J-345/J-355/J-365 Control Panel

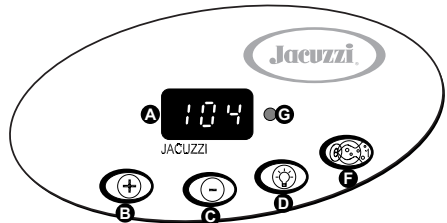

1-Pump J-315/J-325 Control Panel

**D. Light On/Off Button**

- **J-335/J-345/J-355/J-365 Models:** Turns waterfall, footwell light, lighted cup holders and backlit pillows on in unison. Press once for high intensity; press a second time for medium intensity; press a third time for low intensity; press a fourth time to turn off. The displayed color is changed using the light mode button (E) below.
- **J-335/J-345/J-355/J-365 Models:** Controls Spa Light. See section 9.3, page 22 for details.

**E. Light Mode Button (J-335/J-345/J-355/J-365 Models Only):**

Selects one of 5 color modes for waterfall, footwell, cup holders, and pillows lights. See page 22 for additional information.

- F. Jets 1 Button:** Turns jets pump #1 on and off. Press once for low speed; press a second time for high speed; press a third time to turn pump off.

- G. Jets 2 Button (2-Pump Models Only):** turns high-speed jets pump #2 on and off. Press once to turn on; press a second time to turn pump off.

- H. Heat Indicator:** Lit when heater is on.

**Operation Details**

- Temperature Adjustment: 65 to 104°F (18 to 40°C). Factory default setting is 100°F (38°C).
- Light Operation: All lights run for 1 hour then shut off automatically.
- **Jets 1/Jets 2 Button Operation:** Jets run for 20 minutes after activated, then turn off automatically to conserve energy. Simply press either jets button to continue operation for an additional 20 minutes.



## 8.2 Spa Features And Controls

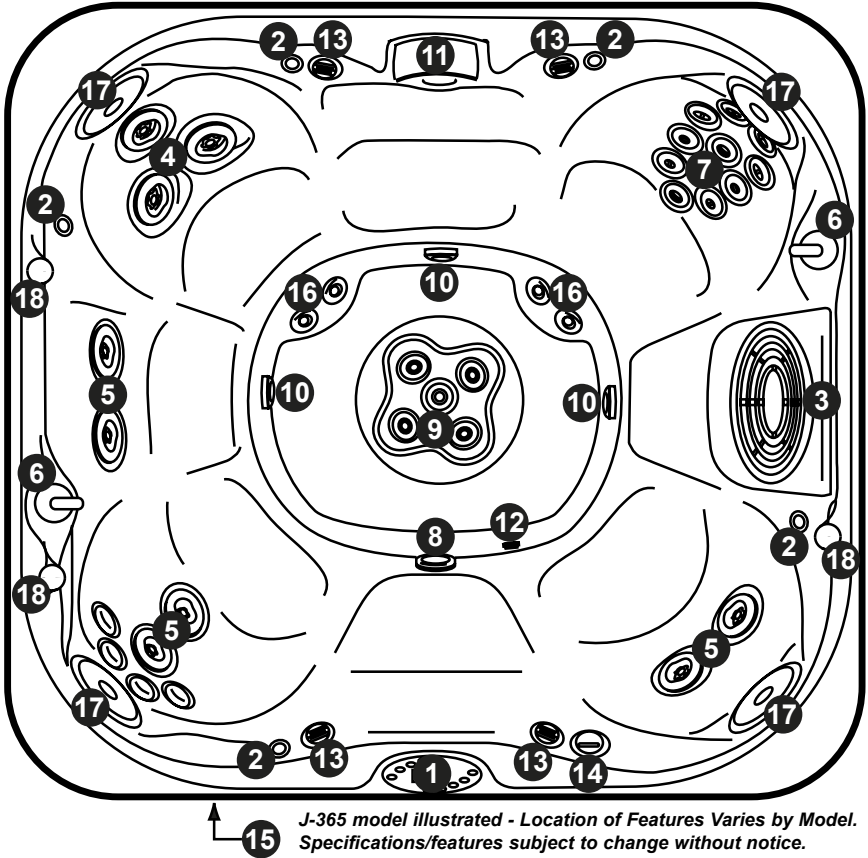

- |                                            |                                                                           |
|--------------------------------------------|---------------------------------------------------------------------------|
| 1. Control Panel                           | 13. Optional Audio System Speakers (J-335/J-345/J-355/J-365 Models Only). |
| 2. Toggle Air Controls                     | 14. Optional Audio System Remote Control                                  |
| 3. Filter/Skimmer Grill                    | 15. Optional Audio System Receiver (J-335/J-345/J-355/J-365 Models Only)  |
| 4. PowerPro MX Jets                        | 16. Calf Jets                                                             |
| 5. Therapy Jets                            | 17. Backlit Pillows*                                                      |
| 6. Massage Selector Valves                 | 18. Lighted Cup Holders*                                                  |
| 7. Therapy Seat                            |                                                                           |
| 8. Spa Light                               |                                                                           |
| 9. Vertical Jets (Foot Jets)               |                                                                           |
| 10. Footwell Suction Fittings and Filters. |                                                                           |
| 11. Waterfall Feature                      |                                                                           |
| 12. Heater Return Fitting                  |                                                                           |

*\*Light features not offered on J-315/J-325 Models.*





## 9.0 Operating Instructions

The spa control system has automatic functions that operate upon start-up and normal operation to protect the system. Upon power up, the readout displays the following information:

1. Control panel displays current software release (e.g. 3.56), then;
2. Control panel displays “888” and all indicator LEDs are lit, permitting visual inspection of all display segments and indicator lights for proper operation.
3. After the initial start-up sequence ends, the actual water temperature is displayed. If water temperature at this time is less than the factory default temperature setting of 100°F (38°C) and the spa is set to either standard filtration/heating mode “F0-F3”, the heater will turn on and run until the water temperature rises to the factory setting, then turn off. *Note: it is common for the heater to turn on after the spa is first filled because tap water is often very cold.*



### 9.1 Setting Water Temperature

The spa's thermostat provides optimum control of water temperature. The temperature set point (set temperature) can be adjusted from 65°F to 104°F (18°C to 40°C). To raise the set temperature, press the **WARMER ( + )** button. To lower the set temperature, press the **COOLER ( - )** button. *Note: The first press of either **WARMER ( + )** or **COOLER ( - )** button displays the set temperature.*



### 9.2 Activate Pumps

The **JETS 1** button activates the functions of the main 2-speed jets pump. The first press activates jets pump 1 in low speed, the second press activates high speed, and the third press shuts the pump off. The **JETS 2** button controls jets pump 2 which operates only in high speed. Both jets pumps have a twenty-minute default when manually activated.

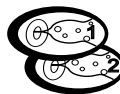



### 9.3 Light Operation (J-315/J-325 Models Only)

The spa light offers 6 constant color variations and a unique random mode for enhanced spa enjoyment. Press the LIGHT button once to turn the spa light on in “Random” mode, then repeatedly press the button to turn the light off or to select one of 6 constant colors illustrated below.

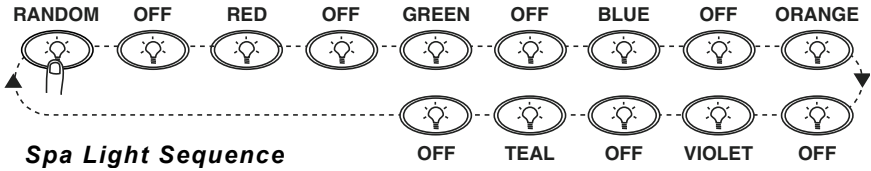

*You must press the LIGHT button within 5 seconds between each “off” or “color” step in the light sequence to prevent it from resetting. Pressing the button after 5 seconds restarts the sequence at “Random” mode. This mode automatically changes the light color every 8 to 20 seconds. Note: Any time the spa light is manually turned on, it will automatically turn off after approximately 1 hour. If you desire more light at this time, simply turn the light back on.*

#### 9.4 Light On/Off Button (J-335/J345/J-355/J-365 Models)

Pressing this button activates the logo, footwell IX Jet light, and waterfall lights in sequence as follows: high - medium - low - off. *Note: lights automatically turn off after 2 hours.*



#### 9.5 Light Mode Button (J-335/J345/J-355/J-365 Models)

This button offers 5 light modes for your enjoyment. Press this button to select your favorite lighting effect as follows:

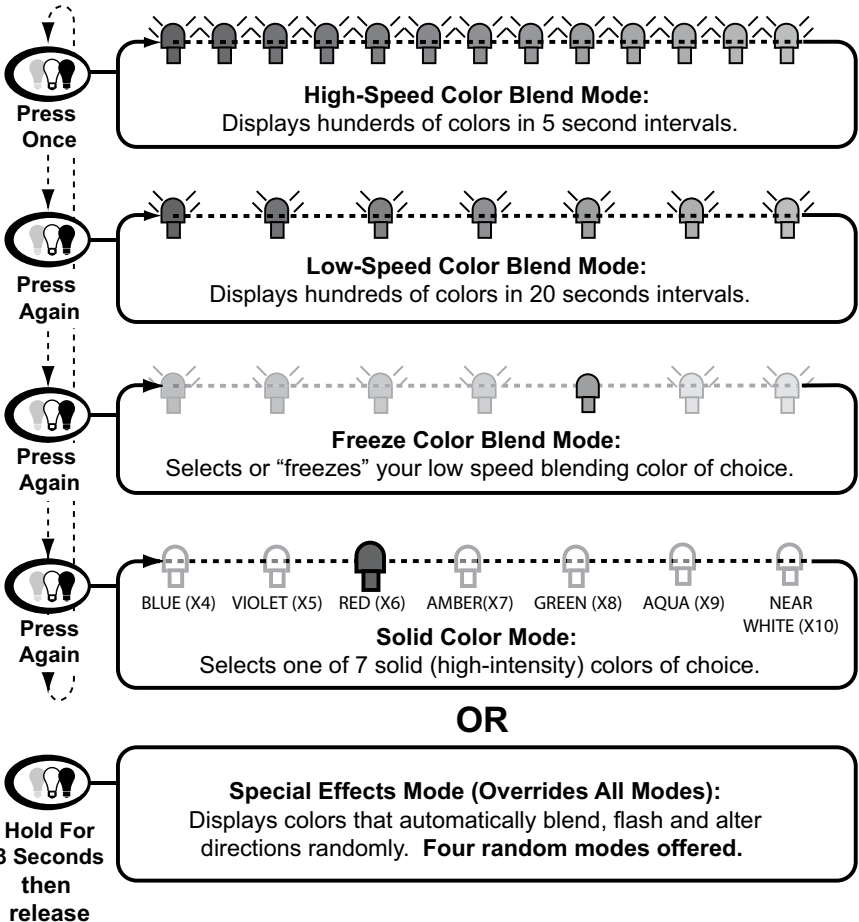

*Note: All modes are automatically recalled when the hot tub lights are turned off and back on within 5 seconds, otherwise they default to the high-speed blending mode. Solid color mode is retained indefinitely unless set otherwise or a power outage occurs.*



## 9.6 Selecting Desired Massage Action

Your Jacuzzi® spa is equipped to allow you to customize the massage action you desire. Each model incorporates a massage selector that allows you to customize the massage and performance by diverting water between various jet systems. Simply turn massage selector to position A (Combo), B, or C to divert water pressure to various jet groups.

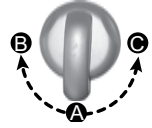

**Note:** This valve is intended to operate in positions A (Combo), B, and C for optimum performance. It is considered normal for sound levels within the valve to vary between positions due to the large amounts of water flowing through it! For optimum filtration benefits, leave the valve in position A when spa is covered. Select position B or C for maximum jet performance during spa use.

## 9.7 Adjusting Individual Jet Flow

The water flow to the individual jets in your spa can be increased or decreased by rotating the outside jet face. **Note:** Always keep at least 6 adjustable jets open at all times.



## 9.8 Adjusting PowerPro Jets

With the nozzles of the PowerPro Jets positioned straight ahead, the jet stream will be stationary. Pushing the nozzle to one side causes the jet nozzle to rotate, moving the jet stream in a circular pattern. **The jets may not spin with Jets pump 1 on low speed.**



## 9.9 Waterfall Feature

The waterfall feature allows you to independently control it for a customized soothing effect. The **JETS 1** button activates the waterfall feature. **Note:** The operation of the waterfall light feature is covered in sections 9.4-9.5 (page 23).

Waterfall Operation Details:

- J-315/J-325 Models: move control lever next to the waterfall body inward to start or increase flow or move lever outward to slow or turn off flow.
- J-335/J-345/J-355/J-365 models:
  - A. Push thumb wheel on top of waterfall to the left (while in spa) to start or increase flow.
  - B. Push thumb wheel on top of waterfall to the right (while in spa) to slow or turn flow off.



### 9.10 Air Controls

Certain jet systems have their own “toggle” on/off air control. Each control introduces air into the water lines that supply specific jet groups. Simply press any air control button Jacuzzi Logo down to open or press the opposite side of the button to close.



*Note: To minimize heat loss, close all air controls (Jacuzzi logos up) when spa is not in use. Certain jets may not draw air when jets pump 1 is running in low speed; this is considered normal.*

### 9.11 Optional Audio System (J-335/J-345/J-355/J-365 Models Only)

Spas equipped with the optional Jacuzzi audio system offer enhanced spa enjoyment. These models include an integrated AM/FM/CD receiver with four high-quality marine speakers for unsurpassed sound quality and long-life. Refer to section 19.0, (page 43) for complete stereo details.



## 10.0 Automatic Filtration Cycles

Your new spa includes a 24-hour circulation pump which filters the water continuously. The circulation pump draws water through the skimmer bag and one of two filter cartridges to effectively remove small debris in your spa. *Note: the 24-hour circulation pump system also supplies heated water to the spa when the heater turns on.*

The control system activates a programmable “standard” or “economy” filtration/heating cycle to remove larger debris missed by the 24-hour circulation pump filtration system. These cycles utilize pump #1 low speed and the filter cartridge to quickly “skim” the water of large debris and minimize their “bath-tub ring” effect. Apart from their skimming benefit, each mode also effects the operation of your spa’s heater. Refer to sections 10.1 and 10.2 below for additional information.

### 10.1 Standard Filtration/Heating Modes (F0 - F3)

Standard filtration/heating modes are typically selected by customers in cold climates where heat up times are extended due to lower ambient temperatures. In these modes, the water temperature is regulated by the set temperature, 24-hour circulation pump, and heater which turns on as needed. After the programmed set temperature is reached, the heater turns off and the circulation pump continues to operate 24-hours to filter and clean your spa (unless in summer logic; see section 13.1, page 34).

### 10.2 Economy Filtration/Heating Modes (F4 - F6)

Economy filtration/heating modes are typically selected by customers in



warm climates where heat up times are minimized due to higher ambient temperatures. In these modes, the water temperature is regulated by the set temperature, 24-hour circulation pump, and heater only while a programmed filter cycle is running (unless in summer logic; see section 13.1, page 34).

### 10.3 Lock Modes (L1 - L2)

These modes are designed for use during spa service or to prevent unauthorized use.

### 10.4 Selecting The Filtration/Heating Mode

Press and hold both control panel **WARMER ( + )** and **COOLER ( - )** buttons **at the same time**, then release. Then press either **WARMER ( + )** or **COOLER ( - )** button to select filtration/heating mode F0-F6 or lock modes L1-L2 below.

#### Standard Filtration/Heating Modes

- F0** 5 minutes of filtration per day (one 5 minute “Blow-Out” cycle every 24 hours to purge all plumbing lines)
- F1** 1 hour of filtration per day (one 30-minute cycle every 12 hours); this is the factory default setting.
- F2** 1.5 hours of filtration per day (one 30-minute cycle every 8 hours)
- F3** 2 hours of filtration per day (one 30-minute cycle every 6 hours)



#### Economy Filtration/Heating Modes

- F4** 1 hour of filtration/heating per day (one 30-minute cycle every twelve hours)
- F5** 1.5 hours of filtration/heating per day (one 30-minute cycle every eight hours)
- F6** 2 hours of filtration/heating per day (one 30-minute cycle every six hours)

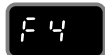

#### Lock Modes

- L1** Lock Out (disables all spa functions to permit filter cleaning)
- L2** Lock Mode (disables the jets and light buttons to prevent unauthorized use of spa.) Filtration/heating cycle will continue to operate as programmed in this mode. The temperature display flashes when this function is enabled.





**Example:** the “F3” filtration/heating cycle was enabled prior to choosing lock mode. The spa continues to perform the “F3” cycle until lock mode is canceled, allowing another cycle to be selected.

To set a time for the first filtration/heating cycle, simply turn power on to the spa two minutes prior to the desired time. **EXAMPLE:** If you desire your first filtration/heating cycle to begin at 10:00 AM turn off power to the spa and turn it back on again at 9:58 AM. Note: start time is approximate and may vary slightly from day to day.

## 11.0 Spa Maintenance

Proper and regular maintenance of your spa will help it retain its beauty and performance. Your authorized Jacuzzi dealer can supply you with all the information, supplies, and accessory products you will need to accomplish this.

### 11.1 Cleaning The Filters

Your Jacuzzi spa is equipped with a skimmer bag and two high performance filter cartridges located inside the filter skimmer. Fine debris are filtered by the circulation pump drawing water through the skimmer bag and circulation pump cartridge. Larger debris are filtered by the 2-speed jets pump #1 drawing water through the skimmer bag and main pump cartridge during normal operation and at each filtration/heating cycle. The skimmer bag and filter cartridges provide unsurpassed water quality by trapping surface and suspended particles.

An optional chemical feeder is available through your authorized Jacuzzi dealer that installs under the filter cap (#2472-673). Always remove the chemical feeder cap and feeder (when used) during the filter cleaning process by turning the cap handle counterclockwise. Reinstall the cap and feeder back onto the filter cartridge after the filter cleaning process is complete. To avoid touching the chemical feeder, it is recommended that latex gloves be used during this process. **Note: when used, the chemical feeder MUST remain on the circulation pump filter cartridge! This filter cartridge is the one with the grid across the wall fitting as shown (right).**

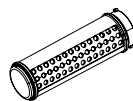

The J-335, J-345, J-355 and J365 models include filters on their footwell suction covers that prevent debris from entering pump #2, when operating. These filters must remain in place to protect





pump #2's plumbing network. They should be cleaned every 2 months, or when weak pump #2 performance is observed. To ensure optimum performance, clean and reuse both main filter cartridges once a month.

**ALWAYS TURN POWER TO SPA OFF BEFORE CLEANING THE FILTER CARTRIDGES!** Note: when replacing the filter cartridges, the chemical feeder must remain on the circulation pump inlet. The circulation pump inlet will have a grid across the wall fitting. 

Refer to the filter cleaning/replacement procedure below:

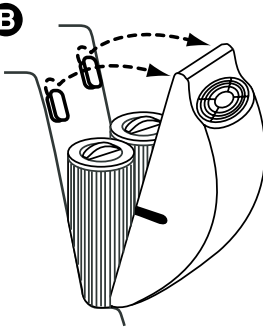
**A****TURN POWER TO SPA OFF!****B**

Lift cover approx. 3/8" to unclip, then tilt forward to access filter cartridges.

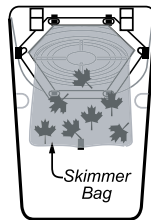
**C**

(Filter Cover Back View)

Remove skimmer bag from clips, clean out, then reinstall onto filter cover.

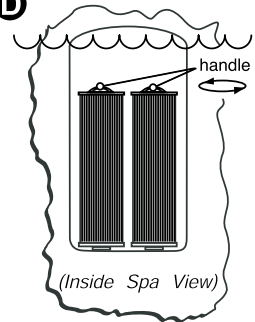
**D**

(Inside Spa View)

Rotate each filter cartridge handle counterclockwise to unthread from mating wall fitting.

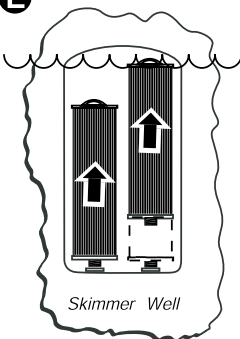
**E**

Skimmer Well

Remove both filter cartridges from skimmer well.

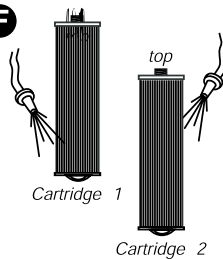
**F**

Cartridge 1

Cartridge 2

If used, remove the chemical feeder as instructed prior to rinsing the filter cartridges. Rinse debris from filter pleats on each cartridge using a garden hose and high-pressure nozzle. Start at the top and work downward to the handle. Repeat until all pleats are clean.

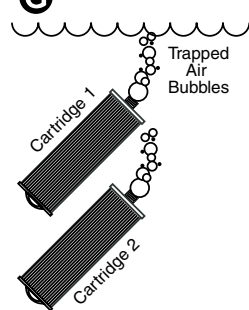
**G**

Submerge both filter cartridges in spa. Tilt threaded end upward to remove trapped air bubbles from each cartridge, then keep both cartridges submerged for step H.



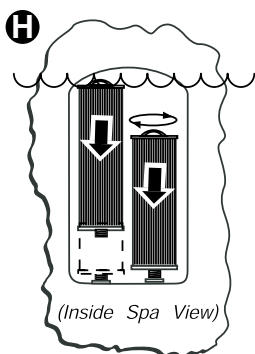

Place each cartridge back into skimmer well\*, then rotate each cartridge handle clockwise to thread back into wall fitting. **DO NOT OVERTIGHTEN!**

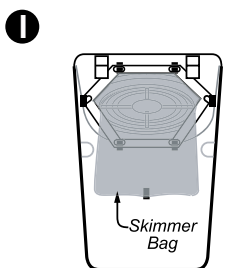

(Filter Cover Back View)

Install clean skimmer bag back onto clips as shown.

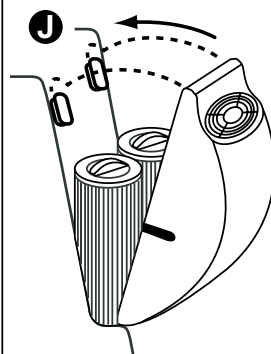

1. Tilt filter cover back against clips, then lift approx. 3/8" to latch against spa shell.
2. Turn power to spa back on.

Periodically, both filter cartridges will need a more thorough cleaning to remove imbedded oils and minerals. For this, we suggest cleaning as illustrated in step "F", followed by soaking the filter overnight in a plastic container filled with a solution of water and specially formulated filter cleanser available from your authorized Jacuzzi dealer. The chemical feeder should be removed during this process. The average life expectancy of each filter is approximately two years with proper care and water quality maintenance. Replacement cartridges may be purchased from your Jacuzzi dealer.

## 11.2 Draining And Refilling

About every 3 months, you will want to replace the spa's water. The frequency depends on a number of variables including the amount of use, attention paid to water quality maintenance, etc. You will know it is time for a change when you cannot control sudsing and/or you can no longer get the normal feel or sparkle to the water even though the key water balance measurements are all within the proper parameters.



**CAUTION! READ THIS BEFORE DRAINING:** To prevent damage to the spa's components, **turn off power to the spa at the circuit breaker before draining it.** Do not turn the power back on until your spa has been refilled.



**CAUTION:** There are certain precautions to keep in mind when draining your spa. If it is extremely cold and the spa is outdoors, freezing could occur in the lines or the equipment (see “WINTERIZING”, page 32). On the other hand, if it is hot outdoors, do not leave the spa’s surface exposed to direct sunlight.

To drain your spa, perform the following steps:

1. Turn off power to spa at breaker.
2. Locate the drain valve on the front/lower plastic pan. Hold the larger (rear) body to prevent it from turning, then loosen and remove the front cap to expose the underlying male hose threads.
3. Attach a garden hose to the exposed threads.
4. Gently rotate the larger (rear) valve body 1/3 turn counterclockwise to unlock the drain valve.
5. Pull the larger (rear) body outward to open drain.
6. After the spa drains, perform steps 2-5 in reverse order to close the drain prior to refilling the spa.

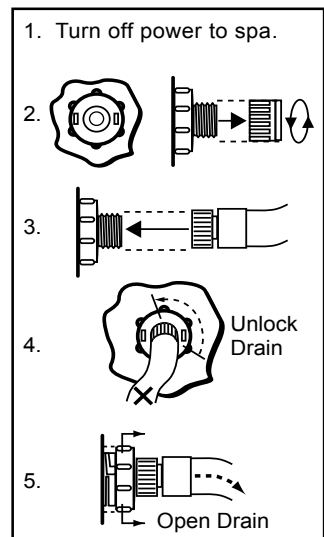

**After refilling, turn on power to the spa and follow the steps listed under “Spa Fill Up Procedure” (page 14). Always fill your spa through both filter wall fittings.**

### 11.3 Cleaning The Spa Interior

To preserve the sheen of your spa’s surface, it is crucial that you avoid using abrasive cleaners or cleaners which have adverse chemical effect on the surface. If you are not certain as to the suitability of a particular cleanser, consult your authorized Jacuzzi dealer. Regardless of the cleanser used, use extreme care to assure that no soap residue is left on the surface. This could cause severe sudsing when the spa is refilled.



### 11.4 Pillow Care

Remove and clean the headrest pillows as needed with soapy water using a cloth or soft-bristle brush. To maintain water resistance and luster, apply a quality vinyl conditioner once a month. Always remove the pillows when adding chemical shock treatment to the spa water. When the sanitizer reading is below 4.0 ppm, pillows can be reinstalled.



**CAUTION:** Never attempt to remove the pillows by pulling on the complete assembly! The pillows utilize a bolt-on design that prohibits removal without tools.

To remove pillows:

1. Grasp pillow insert (A) with finger tips and gently pry outward from pillow base (C).
2. Use a standard screwdriver to loosen and remove mounting bolts (B) from pillow base.
3. Assemble in reverse order after cleaning. **DO NOT overtighten pillow mounting bolts!**

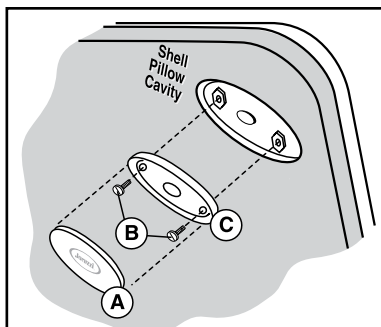

### 11.5 Maintaining The Cover

Using the Jacuzzi insulating spa cover anytime the spa is not in use will significantly reduce your operating costs, heat-up time and maintenance requirements. To prolong the life of the cover, handle it with care and clean it regularly using mild soap and water. Periodic treatments with a special conditioner developed for Jacuzzi spa covers, will help protect against deterioration caused by UV rays from the sun. Never allow anyone to stand or sit on the cover, and avoid dragging it across rough surfaces.

### 11.6 Maintaining The Synthetic Cabinet

Your new Jacuzzi synthetic spa cabinet requires little or no maintenance of any kind. To clean, simply wipe cabinet with a clean towel and mild soap solution.



**CAUTION:** Never spray cabinet with a garden hose for any reason since this action may induce an electrical short in the spa's electrical equipment.



## 11.7 Winterizing

Your Jacuzzi® spa is designed to automatically protect itself against freezing when operating properly. During periods of severe freezing temperatures, you should check periodically to be certain that the electrical supply to the spa has not been interrupted. In extreme, bitter cold weather less than -20°F (-29°C), choose the F3 “Standard” filtration/heating mode to prevent freezing (page 26).

If you do not intend to use your spa, or if there is a prolonged power outage during periods of severe freezing temperatures, it is important that all water be removed from the spa and equipment to protect against damage from freezing. **For expert winterization of your spa, contact your authorized Jacuzzi dealer.** In emergency situations, damage can be minimized by taking the following steps:

1. Turn off power to the spa.
2. Follow the directions on page 29-30 for draining the spa.
3. As the water level drops below the seats, use whatever means necessary to get the water out of the recessed seating areas and into the footwell.
4. When the water level ceases to drop, use whatever means available to remove any remaining water from the footwell.
5. Remove the equipment-side cabinet panel and locate the drain plugs in the front of the pump(s) (Figure-A, page 13). Remove these plugs to allow the water to drain out of the pumps and heater. *Note: Approximately one to two gallons will be released during this procedure. Use a wet/dry vacuum or other means to keep this from flooding the equipment compartment. Replace the drain plugs.*
6. Loosen the hose clamp on the circulation pump intake behind the control box (Figure-A, page 13) and pull the hose off (twist hose back and forth while pulling outward). Tip hose down and allow to drain, then reinstall hose and clamp.
7. Re-install cabinet side panel and cover spa so that no casual moisture can enter into it.

Consult your authorized Jacuzzi dealer if you have any questions regarding winter use or winterizing.

## 11.8 Restarting Your Spa in Cold Weather

If you want to start up your spa after it has sat empty for a time in freezing temperatures, be aware that the water remaining in certain sections of the piping may still be frozen. This situation will block water flow



preventing the spa from operating properly and possibly damaging the equipment. We recommend you consult your authorized Jacuzzi dealer for guidance before attempting to re-start your spa under these conditions.

## 12.0 Water Quality Maintenance

Maintaining the quality of the water within specified limits will serve to enhance your enjoyment and prolong the life of the spa's equipment. It is a fairly simple task, but it requires regular attention because the water chemistry involved is a balance of several factors. There is no simple formula, and there is no avoiding it. A careless attitude in regard to water maintenance will result in poor and potentially unhealthful conditions for soaking and even damage to your spa. For specific guidance on maintaining water quality, consult your authorized Jacuzzi dealer who can recommend appropriate chemical products for sanitizing and maintaining your spa.



**CAUTION:** *Never store spa chemicals inside the spa's equipment bay.*

### 12.1 pH Control

pH is a measure of relative acidity or alkalinity of water and is measured on a scale of 0 to 14. The midpoint of 7 is said to be neutral, above which is alkaline and below which is acidic. In spa water, IT IS VERY IMPORTANT TO MAINTAIN A SLIGHTLY ALKALINE CONDITION OF 7.4 to 7.6. Problems become proportionately severe the further outside of this range the water gets. A low pH will be corrosive to metals in the spa equipment.

A high pH will cause minerals to deposit on the interior surface (scaling). In addition, the ability of the sanitation agents to keep the spa clean is severely affected as the pH moves beyond the ideal range. That is why almost all spa water test kits contain a measure for pH as well as sanitizer.

### 12.2 Sanitizing

To destroy bacteria and organic compounds in the spa water, a sanitizer must be used regularly. Chlorine and Bromine are the two most popular sanitizers used to date. Many other additives are available for your spa.



Some are necessary to compensate for out-of-balance water, some aid in cosmetic water treatment and others simply alter the feel or smell of the water. Your authorized Jacuzzi dealer can advise you on the use of these additives.



**CAUTION:** *Do not use Chlorine tablets (Trichlor) in your spa. This chemical can have an extremely corrosive effect on certain materials in the spa. Damage caused by use of this chemical, or improper use of any chemicals, is not covered under the spa's warranty.*

### 12.3 Optional CD Ozone Water Maintenance System

If you have elected to have your spa equipped with the optional Jacuzzi CD ozone water purification system you will find that your water stays fresh and clear with significantly less chemical sanitizer usage. You will also probably be able to go longer between complete spa drainings. The CD ozone unit operates in conjunction with the circulation pump.

## 13.0 Error Conditions / Error Messages

### 13.1 Summer Logic

When the actual spa water temperature reaches up to 2°F (1°C) above the set temperature, the spa goes into “summer logic” causing the circulation pump and heater to turn off automatically. This will avoid the addition of heated water to the spa, which would eventually create an overheat condition. This setting is not user-programmable.

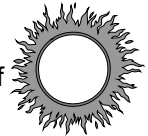

**Note:** *The summer logic does not take effect until the spa water temperature reaches 95°F (35°C). This condition is more likely in excessively hot weather. Remember, the spa's ability to cool is directly affected by the ambient temperature. An excessively hot ambient temperature may prevent the spa from cooling down because it's fully insulated construction is designed to retain heat and to minimize operating costs.*



### 13.2 Overheat Condition

**WARNING! DO NOT ENTER SPA WATER!** Water is too hot. Overheat protection. Heater is deactivated. Spa water temperature is above acceptable limits. Do not enter the water



#### To correct condition:

1. Remove the spa's cover and allow your spa to cool down.
2. Program the filter settings for Economy Mode (F4-F6), page 26. Raise water temperature setting to cancel Summer Logic condition (page 34).
3. If the condition persists, contact your authorized Jacuzzi dealer.

### 13.3 Panel Displays SN1

Open sensor (heater is disabled) or shorted sensor (spa is deactivated). The high-limit temperature sensor is not functioning. Your authorized Jacuzzi dealer/service center must repair this.



### 13.4 Panel Displays SN2

Open or shorted sensor (heater disabled). The temperature sensor is not functioning. Your authorized Jacuzzi dealer must repair this.



### 13.5 Panel Displays FL1 or FL2

A flashing "FL1" display means the flow switch is malfunctioning open, the circulation pump's filter cartridge is excessively dirty, or an "air lock" condition has occurred at the circulation pump intake. A flashing "FL2" display means the flow switch is malfunctioning closed.



- This error will cause the heater to deactivate. The main pump #1 may also deactivate.
- This problem is caused by an interruption in water flow from an excessively dirty filter cartridge, an "air lock" condition at the pump intake, or by a malfunctioning flow switch.



### To Correct Condition:

1. Check for proper water level. Water should be 1" below lowest pillow.
2. Check for clogged/excessively dirty circulation pump filter cartridge (control panel side). See section 11.1 (page 27).
3. Purge "air lock" from circulation pump intake by removing its filter cartridge (control panel side). Place your garden hose over the heater return wall fitting near the underwater spa light (sec. 8.2, page 20). Turn-on water for 30 seconds, then turn off. Reinstall filter cartridge and check spa. See section 11.1 (page 27).
3. If problem persists, contact your authorized Jacuzzi dealer.

### 13.6 Panel Displays COL

Cool Condition - Temperature has dropped 20°F (11°C) below the current set temperature. The pump and heater have been activated to bring the temperature to within 15°F (8°C) of the set temperature. No corrective action is required. *Note: during cold periods, you may consider increasing the number of filtration cycles.*

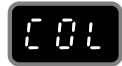

### 13.7 Panel Displays ICE

Freeze Protection - A potential freeze condition has been detected. No action is required. Main pump #1 will operate to circulate warm water through the plumbing until the spa is out of danger.



### 13.8 Panel Displays - - -

The safety "Watchdog" software has been triggered and the spa is deactivated. A problem has been detected which could cause damage to the spa or its components. Contact your authorized Jacuzzi dealer.



## 14.0 Troubleshooting Procedures

In the event your Jacuzzi® spa is not working the way it should, please first review all the installation and operating instructions in this manual and check the message on the panel display. If you are still not satisfied it is working properly, please follow the appropriate troubleshooting instructions. *Note: If any of the supply cords to the accessories are damaged, they must be replaced by an authorized Jacuzzi dealer or service personnel.*





### 14.1 None of the Components Operate (e.g. Pump, Light)

Check the following:

1. Is there power to the spa?
2. Is the household circuit breaker tripped?
3. Call your authorized Jacuzzi dealer.

### 14.2 Pump Does Not Operate but Light Does

Press the Jets 1 Button:

1. If no water movement is detected, make sure power is going to the spa and check the water level. If it does not solve the problem, contact your authorized Jacuzzi dealer.
2. The main pump #1 operates but no water flows to jets. one of the Jets pumps may not be properly primed. This can happen after the spa is drained and refilled. Press the Jets 1 button several times, never leaving the pump on for more than 5 to 10 seconds at a time. Turn power off and let the air out by loosening the cap on the massage selector and/or remove the filter (page 20). Make certain you tighten the massage selector cap and/or reinstall the filter before turning on spa power and restarting the pump.

### 14.3 Poor Jet Action

1. Press the Jets 1 button to make certain that jets pump #1 is on.
2. Depress the air control to the "on" position.
3. Check for dirty filter. Clean, if necessary.
4. Make sure all adjustable jets are open (page 24).

J-335/J-345/J-355/J-365 models include filters on their footwell suction covers that prevent debris from entering jets pump #2, when operating. These filters must remain in place to protect jets pump #2 plumbing network. They should be cleaned every 2 months, or when weak pump #2 performance is observed.





#### **14.4 Water is Too Hot**

1. Reduce thermostat setting.
2. Reduce filtration/heating cycle length. Even with heater off, water temperature can increase from prolonged pump operation (section 10.4, page 26).
3. Manually induce “Summer Logic” by setting water temperature to a value of 2 degrees less than the current set temperature. Refer to section 9.1 (page 21) for further details.

#### **14.5 No Heat**

1. Check thermostat setting.
2. Keep the spa cover in place while heating.
3. Check the settings to see if your spa is in economy mode (page 26). Should checking the above steps fail to correct the problem, please call your dealer so that they may arrange service.

We build the best spas in the industry. Nonetheless, we are always striving to improve the quality and features of our products. Your input as a Jacuzzi spa owner is a cherished part of this process. If you have any comments or suggestions, or if you wish to be informed on any new products for your spa, please write to us.

**CONGRATULATIONS** on your good taste and welcome to the happiest and most relaxed family in the world!

## 15.0 J-315 Convertible Circuit Diagram (60Hz)

This wiring diagram is used for the J-315, US/Canada 120/240 VAC (60Hz) convertible power model.

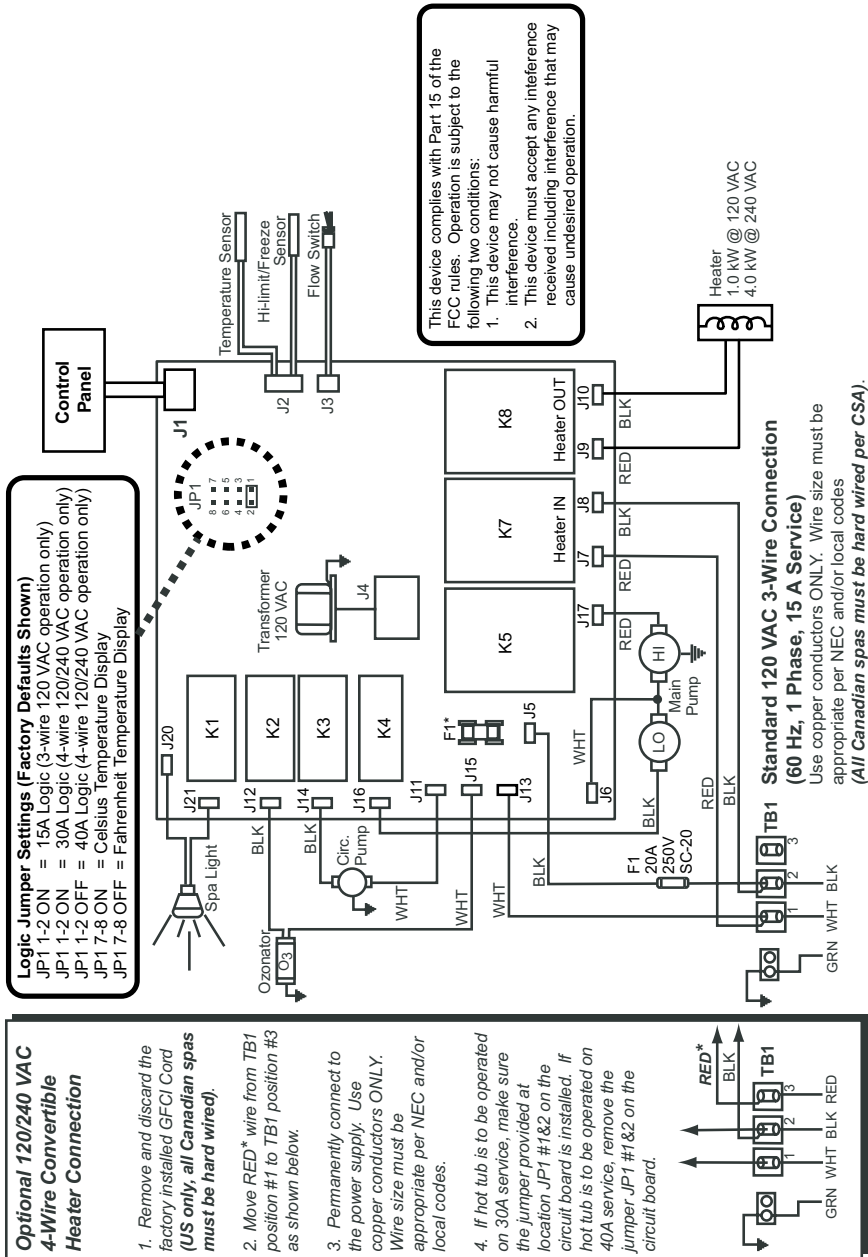



# 16.0 J-325/J-335/J-345/J-355/J-365

## Circuit Diagram (60Hz)

This wiring diagram is used for all J-325/J-335/J-345/J-355/J-365 US/Canada 240 VAC (60Hz) dedicated power models.

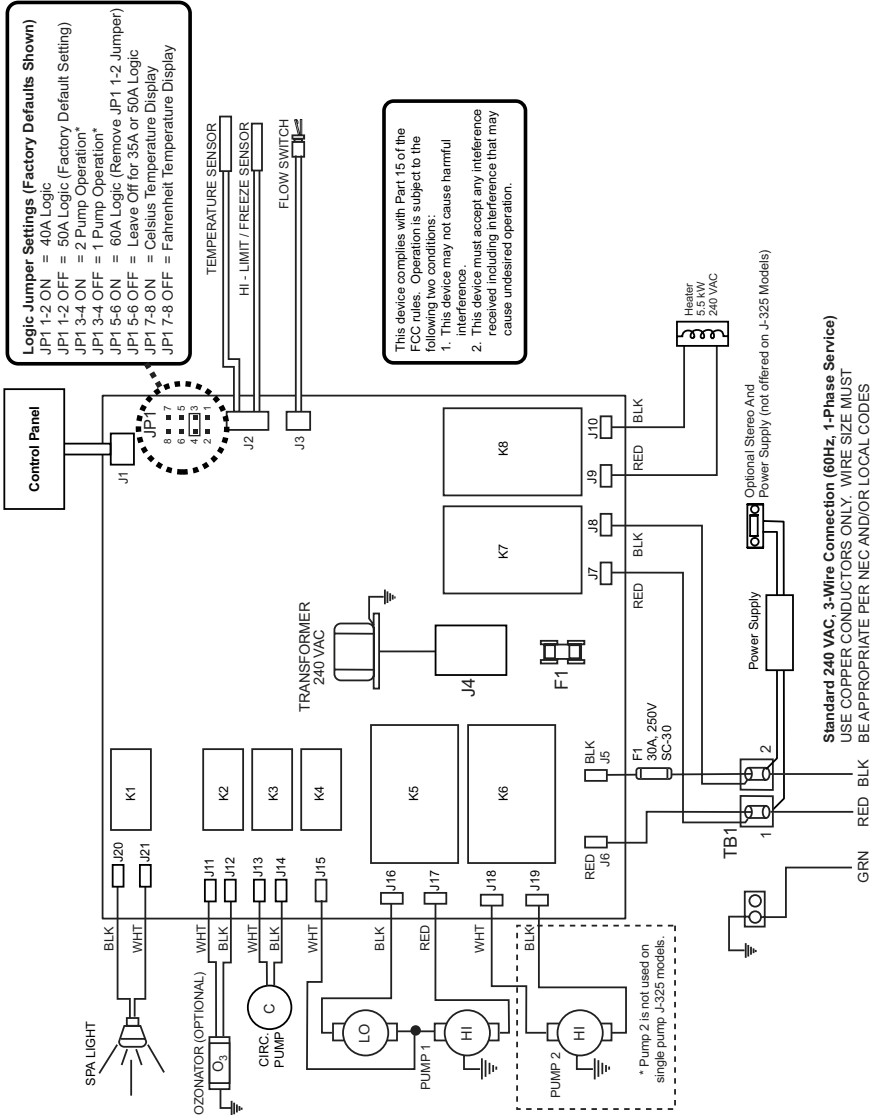

## 17.0 J-315 Export Circuit Diagram (50Hz)

This wiring diagram is used for the J-315 Export 230 VAC (50Hz) dedicated power model.

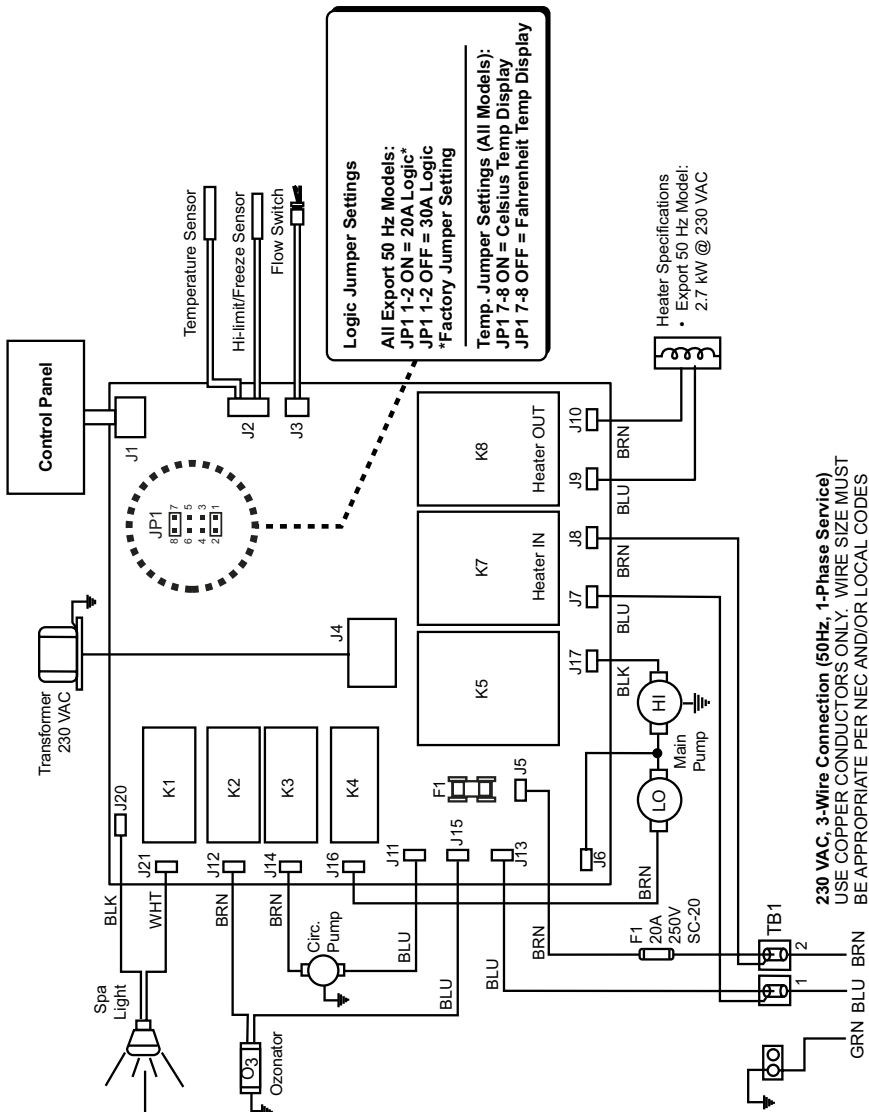



# 18.0 J-325/J-335/J-345/J-355/J-365

## Circuit Diagram (50Hz)

This wiring diagram is used for all J-325/J-335/J-345/J-355/J-365 Export 230 VAC (50Hz) dedicated power models.

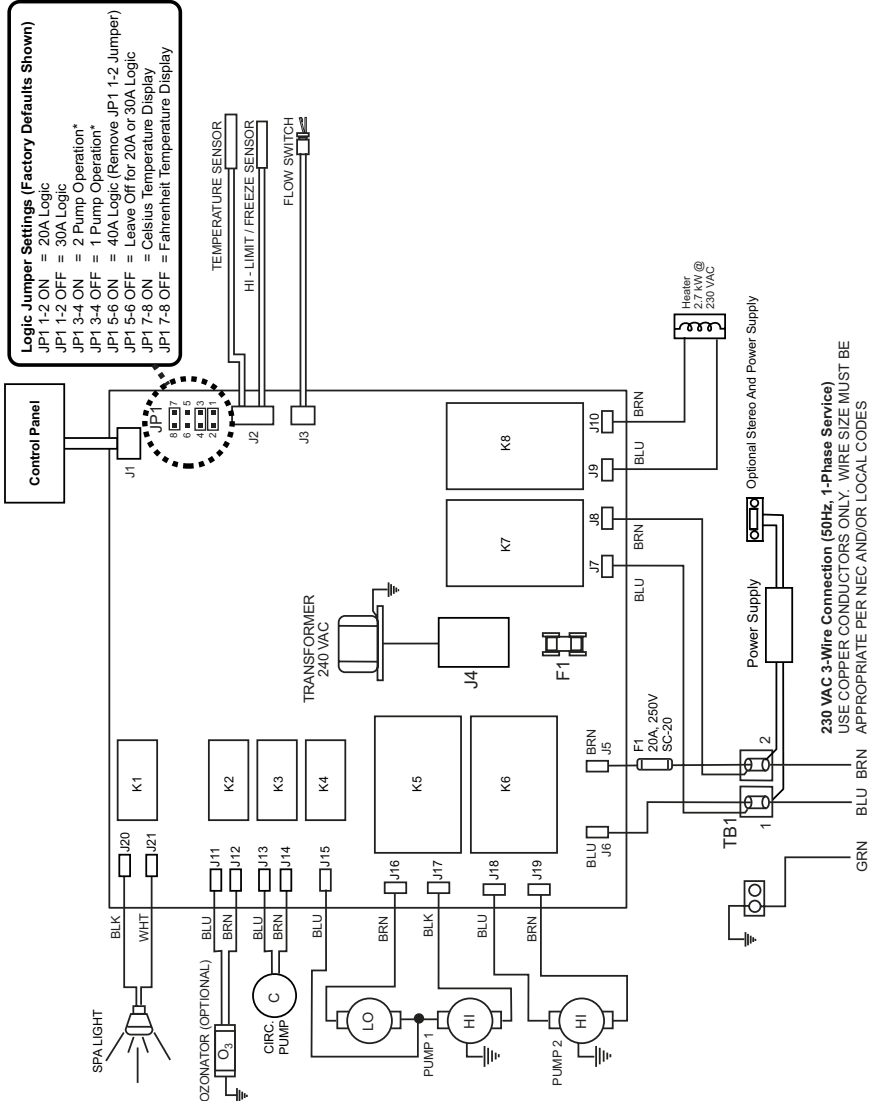

## 19.0 Optional Stereo Receiver Functions

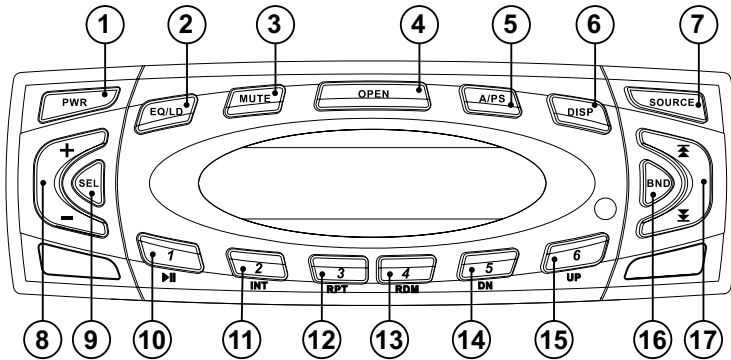

To start enjoying your new Stereo Receiver, please read the following operation instructions in their entirety.

1. **Power Button:** Press PWR (Power) to turn deck on or off.
2. **Equalization Button:** Repeatedly press EQ/LD to choose from DSP Off, Jazz, Pop, Classic, Rock or Vocal equalization options. Press and hold EQ/LD for 2 seconds to enable or disable the “LOUD” function.

**Special Recommendation:** After you have powered up your Aquatic AV Audio System, we suggest you try one of the preset DSP (digital sound presets) settings to customize the sound in your spas audio system. It's easy, simply press the EQ/LD button (2) to activate the DSP. Then repeatedly press to choose from Jazz, Pop, Classical, Rock and Vocal DSP settings. This will enhance your listening experience and make it more enjoyable.

3. **Mute Button:** Press Mute to mute audio output. Press again to return to previous volume level.
4. **Open Button:** Press Open to flip down the front access panel for CD access. Gently insert CD into slot (DO NOT FORCE!) Make sure to close the front panel to prevent damage to the unit.  
*Note: never insert a wet or moist CD since it may damage the mechanism and void the manufacturer warranty.*

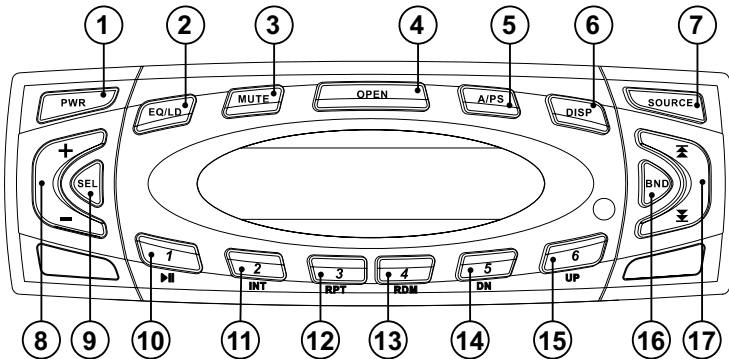

5. **A/PS Button:** Press A/PS to scan station presets. The tuner will scan up, wait for a few seconds, then continue. Once a desired station is found, press A/PS a second time to cancel scan. To automatically scan and store station presets, simply press and hold A/PS for several seconds, then release.
6. **DISP Button:** Press DISP to switch between clock and station frequency. When selected, the clock will display for 5 seconds then automatically revert back to station frequency.
7. **Source Button:** Press Source to change input from audio or CD mode to auxiliary (MP3) mode. Press a second time to switch back. *Note: Auxiliary mode (AUX) enables external MP3 player mode. See section 19.2, page 51 for details.*
8. **Volume Buttons:** Press + (Volume Up) or - (Volume Down) to increase or decrease volume level.
9. **SEL Button:** Press SEL to choose control function:
  - 1) Bass
  - 2) Treble
  - 3) Balance
  - 4) Fader
  - 5) Volume

To adjust selection, press + (Volume Up) or - (Volume Down). Bass control: Adjusts the amount of low frequency. Treble control: Adjusts the amount of high frequency. Balance control adjusts the amount of sound output to the left and right speakers. Fader control adjusts the amount of sound output. You can decrease the sound level of the rear speakers by pressing + (Volume Up). To decrease





the sound level of the front speakers press - (Volume Down). *Note: Bass and Treble settings are available only if EQ is set to DSP Off.*

10. **Preset 1/Pause Play Button:** In tuner mode, any station can be stored as preset 1 by pressing and holding this button for 2 seconds. To recall the station preset, simply press and release this button. In CD mode pressing this button will pause or play the CD.
11. **Preset 2/INT Button:** In tuner mode, any station can be stored as preset 2 by simply pressing and holding this button for 2 seconds. To recall the station preset, simply press and release this button. In CD mode pressing this button will preview each song on the disc for about 10 seconds. Simply press again to turn off this feature.
12. **Preset 3/RPT Button:** In tuner mode, any station can be stored as preset 3 by simply pressing and holding this button for several seconds. To recall the station preset, simply press and release this button. In CD mode pressing this button will play a song repeatedly. Press again to turn off this feature.
13. **Preset 4/RDM Button:** In tuner mode, any station can be stored as preset 4 by simply pressing and holding this button for several seconds. To recall the station preset, simply press and release this button. In CD mode press this button to randomly play song tracks. Press again to turn off this feature.
14. **Preset 5/DN Button:** In tuner mode, any station can be stored as preset 5 by simply pressing and holding this button for several seconds. To recall the station preset, simply press and release this button. In CD mode this button will browse the folders on CD-R and CD-RW disks.
15. **Preset 6/UP Button:** In tuner mode, any station can be stored as preset 6 by simply pressing and holding this button for several seconds. To recall the station preset, simply press and release this button. In CD mode this button will browse the folders on CD-R and CD-RW disks.
16. **BND Button:** Press BND to select one of the following frequency bands: FM1, FM2, FM3, AM1, AM2 and WB (weather band).

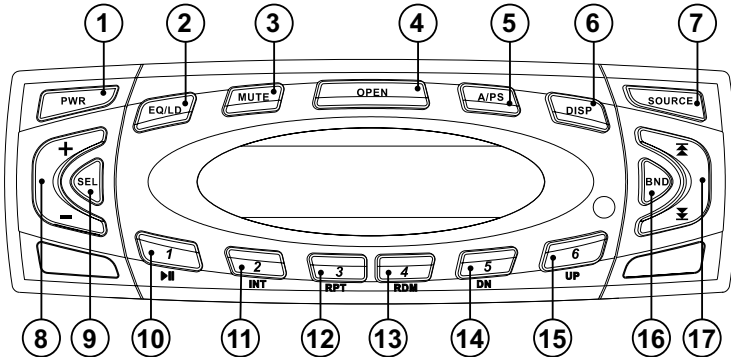

- 17. Tuning UP/DOWN Buttons:** Press Track Up to manually adjust station frequency up. Press and hold Track Up to scan for next higher station. Scan mode stops as soon as a strong station is found. Press Track Down to manually adjust frequency down. Press and hold Track Down to scan for next lower station. Scan mode stops as soon as a strong station is found. In CD mode pressing these buttons will advance the CD up or down to the next or previous track. To fast forward or rewind through a track, simply press and hold either button as desired during CD playback.
- 18. Reset Button (Not Illustrated):** If keys do not function at all and the unit appears to be "locked up", use a ballpoint pen to press the Reset Button under the front panel (press OPEN to flip down front panel for access). The Reset button is located directly below the Eject Button. Press to clear all memory (except station presets) and reset deck. *Note: this action will reset the display and clock to default settings.*
- 19. Eject Button (Not Illustrated):** To eject CD, press OPEN and flip-down the front access panel, then press the Eject button located to the left of CD slot.
- 20. USA/Europe Switch (Not Illustrated):** You can switch between American (USA) and European radio frequency bands by flipping a switch located on the bottom of the deck. To change bands:
- 1) Power down unit
  - 2) Lift up sticker under the CD player.
  - 3) Choose desired frequency band as indicated on the sticker.
  - 4) Put sticker back in place and power up the unit.



21. **Setting The Clock (Unit Must be Off):** To set the current time, press and hold Display (6) for 3 seconds until the clock display starts to blink, then set hours using the Track Up and/or Track Down button (17). Press Display a second time to set minutes, using the Track Up and/or Track Down buttons. Press and hold Display a third time to exit clock setup (or simply wait for 5 seconds).
  
22. **Selecting Weather Band Mode:** Press BND (16) while in tuner mode until WB displays (deck automatically skips to the strongest weather channel) or press BND a second time to return to previous mode. When WB weather band mode is active:
  - 1) Press Track Up (17) to scan to higher weather channel.
  - 2) Press Track Down (17) to scan to lower weather channel.
  - 3) To save a weather channel preset, press and hold one of six numeric keys 1-6. *Note: weather channel 7 is not accessible through preset key.*
  
23. **Display information DISP:** When a retail music CD is inserted, press DISP (6) to change modes as follows:
  - 1) Clock (displays for 5 seconds only).
  - 2) CD track no. / Playtime

When a CD containing MP3 files is inserted, press DISP (6) change modes as follows:

- 1) Clock (displays for 5 seconds only).
- 2) Track no. / Playtime
- 3) Folder name
- 4) File name
- 5) Song name
- 6) Artist's name
- 7) Album name

The system can only display the first 8 letters of ID3 tags. If the recorded information is longer than 8 letters, text will scroll to the left once, then the 8 first letters will be displayed. If specific info has not been recorded on an MP3 disc, NO FOLD, NO TRK, NO TLT, NO ALBM, NO ART will display.

24. **Playback Order of CD with MP3 Files:**
  - 1) A directory that does not include an MP3 file is skipped.
  - 2) We recommend that you make no more than two levels for each disc.
  - 3) Maximum number of folders: 256



- 4) Maximum number of folder levels: 8
- 5) Maximum number of characters for MP3 file name and folder name: 32
- 6) Sampling frequency: 16 kHz, 22.05 kHz, 24 kHz, 32 kHz, 44.1 kHz, 48kHz
- 7) Bit rates: 8-320 Kbps
- 8) MP3 decoding format: MPEG 1 & 2 Audio Layer 3
- 9) Folder names and file names can be displayed with up to 8 characters (see Display key).
- 10) The characters A-Z, 0-9 can be displayed on this unit, other characters may not be displayed correctly.
- 11) ID3 tag is supported (see Display key).

**25. Reading MP3 files from a disc:** When a disc containing MP3 data is loaded, the unit checks all the data on the disc. If the disc contains numerous folders with many levels, it takes a longer time to start playback. In addition, it may take time for the unit to move to the next MP3 file and the fast forward function may not be performed smoothly. When selected to play, files and folders are accessed in order in which they were written by the CD writer. Therefore, the playing order may not be the same as the order in which they are expected. *For example, a disc with the following folder/file hierarchy is subject to folder select, file select and playback order as illustrated on page 49.*

### **Optional SunSound™ Audio Receiver Specifications**

- Marine Grade AM/FM/CD/CD-R/CD-RW/MP3
- 7 Bands of Weather Band
- Stainless Steel Sealed Chassis and Mounting Hardware
- IPX5 Water Intrusion & CFR-46 Rated
- Conformal Coated Printed Circuit Boards
- ASTMB117 Salt Fog Tested 400 Hours
- ASTM D4329 UV Stable Tested 400 Hours
- Double Sealed Water Protection Transport Gaskets
- White Low Current / Low Heat LCD
- White Backlit Control Surfaces
- 5 Band Digital Sound Stage Settings
- 200 Watt, 50 x 4
- MP3 with ID-3 Tag, Video
- Switchable Tuner Frequency U.S. or Euro Band/CE Approved



### Example of a disc's folder/file hierarchy

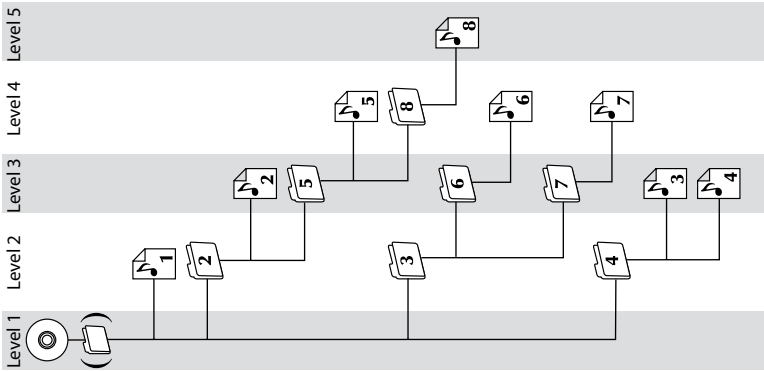

### Operation of the keys



Press **⏮**(Track Down) to select folder down



Press **⏭**(Track UP) to select folder up

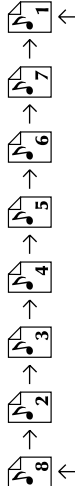

Press and hold **5** **DN** to return 10 files behind.  
Press and hold **6** **UP** to go 10 files forward.



File



Folder



## 19.1 Audio System Remote Control Functions





A remote control is supplied on all spas with the optional stereo system. This remote provides control over all radio and CD playback functions.



### External MP3 Playback

The supplied remote control provides no control over external MP3 player operation of any kind with the exception of volume control and source selection. All External MP3 playback operations are performed solely by the MP3 player. Refer to section 19.2 for external MP3 player connection and operation details.

### Remote Control Radio And CD Functions:

- A. LED Display: displays current radio or CD operation functions and presets.
- B. Feature not available.
- C. Station Preset Button: Press  to choose next AM/FM radio station preset.
- D. Tuning UP/DOWN button: Press  to search for next radio station. In CD mode, press either side of button to advance to next CD track or to recall previous CD track.
- E. Band Button: Press to select FM1, FM2, FM3, AM1, AM2 or WB (weather band).
- F. Source Button: Press  to select AM/FM radio mode, CD mode or AUX mode for external MP3 player use (section 19.2).
- G. Volume Button: Press  to adjust volume level higher or lower.
- H. Power Button: Press  to turn audio system on or off.

## 19.2 External MP3 Player Connection

### A. Connecting An External MP3 Player (Purchased Separately)

Any battery powered MP3 player can be connected to your new spa stereo system to enhance and personalize your spa experience!

#### Connection Procedure

1. Connect MP3 Player to the auxiliary port located inside stereo enclosure using the supplied Mini RCA cable as shown.
2. Plug opposite end of cable into external MP3 player headphone jack, then sit MP3 player on ridge above stereo receiver as shown



### B. Enabling MP3 Playback

1. Select preferred song/album/artist play list on external MP3 player, then start music playback.
2. Press  button on stereo receiver or remote control until display reads “AUX” as shown.

### C. Controlling External MP3 Playback

All MP3 playback operations are performed via the external MP3 players function buttons. The spa stereo deck and/or remote control provide no control functions of any kind with the exception of “Volume” control and “Source” selection.

### D. MP3 Playback Recommendations

For optimum playback convenience, we recommend setting your external MP3 player in the “continuous” playback mode (when available) for uninterrupted music playback.



#### **WARNING: ELECTRICAL SHOCK HAZARD EXISTS!**

Never connect, disconnect or operate external MP3 player while hands are wet or while sitting or standing partially or fully immersed in water!



**The following UL requirements must be observed for all spas with optional stereo components installed.**

- A. "CAUTION - Risk of Electric Shock. Do not leave compartment door open";
- B. "CAUTION - Risk of Electric Shock. Replace components only with identical components"; and
- C. Do not operate the audio/video controls while inside the spa."
- D. "WARNING - Prevent Electrocution. Do not connect any auxiliary components (for example: cable, additional speakers, headphones, additional audio/video components etc.) to the system."
- E. These units are not provided with an outdoor antennae; when provided, it should be installed in accordance with Article 810 of the National Electric Code, ANSI/NFPA 70.
- F. Do not service this product yourself as opening or removing covers may expose you to dangerous voltage or other risk of injury. Refer all servicing to qualified service personnel.
- G. When the power supply connections or power supply cord(s) are damage; if water is entering the audio/video compartment or any electrical equipment compartment area; if the protective shields or barriers are showing signs of deterioration; or if there are signs of other potential damage to the unit, turn off the unit and refer to a qualified service personnel.
- H. This unit should be subjected to periodic routing maintenance (for example, once every 3 months) to make sure that the unit is operating properly.