

**WELCOME TO THE SPA LIFE!**

Please enjoy your new Marquis spa, but think safety first. Read your Owner's Manual in its entirety before installing your spa and encourage all spa users to do the same. More than just common sense, this Owner's Manual provides vital safety and operational information.

We sincerely hope your spa life is a pleasant experience. If problems should arise, contact your authorized dealer. Or contact Marquis Corp. at any of the following:

Email: [service@marquiscorp.com](mailto:service@marquiscorp.com)

Web: [www.marquisspas.com](http://www.marquisspas.com)

Marquis Corp.  
596 Hoffman Road  
Independence, OR 97351



**SERIAL NUMBER LOCATION**

You will find the serial number on the silver tag in the equipment area.

**PLEASE FILL OUT AND KEEP FOR FUTURE REFERENCE**

Name of Purchaser \_\_\_\_\_

Date of Purchase \_\_\_\_\_

Address \_\_\_\_\_

City \_\_\_\_\_ State \_\_\_\_ Zip Code \_\_\_\_\_

Signature \_\_\_\_\_

Telephone \_\_\_\_\_

Spa Model/Color \_\_\_\_\_

Spa Serial # \_\_\_\_\_

Pack Serial # \_\_\_\_\_

Dealer's Name \_\_\_\_\_

Dealer's Address \_\_\_\_\_

City \_\_\_\_\_ State \_\_\_\_ Zip Code \_\_\_\_\_

Telephone \_\_\_\_\_

Every effort has been made to ensure the accuracy of this manual. However, Marquis Corp. reserves the right to improve its product without notice. This could create a minor variation between this manual and the actual product you receive. We apologize for any inconvenience this may cause.

**IMPORTANT SAFETY INSTRUCTIONS**

120V, Cord Connected Models ..... 4  
 240V, Permanently Installed or Converted Models ..... 5  
 Safety ..... 6-9

**INSTALLATION INSTRUCTIONS**

Location ..... 10-11  
 Filter Cartridge ..... 12  
 Electrical Requirements ..... 13-14

**STARTING YOUR SPA ..... 15-16**

**OPERATING YOUR SPA ..... 17**

**SPA SPECIFICATIONS**

630 ..... 18  
 Ultimate 630..... 19-20  
 530..... 21  
 Ultimate 530 ..... 22-23  
 418 ..... 24  
 Ultimate 418..... 25-26  
 315 ..... 27  
 Ultimate 315..... 28-29  
 Rendezvous..... 30  
 Retreat..... 31  
 744E..... 32-33  
 641R..... 34-35  
 520M..... 36-37  
 319S..... 38-39

**SPA CONTROL OPERATION**

All models..... 40-44  
 Soundsations™..... 44-47

**EQUIPMENT DIAGRAM**

630, U630, 530, U530, 744E, 641R,..... 48  
 418, U418, 315, U315, Rendezvous, Retreat, 520M, 319S..... 49

**TROUBLESHOOTING ..... 50-51**

LCD Diagnostic Messages ..... 51

**MAINTENANCE ..... 52-55**

**SPA CARE AND ENJOYMENT GUIDE ..... 56-63**

Water Care Troubleshooting..... 64-65  
 SpaBoutique™ ..... 66

**OWNER'S PROTECTION PLAN..... 67-68**

The following instructions are required to be printed by Underwriters Laboratories (UL) as a condition of the listing of this product. They contain important safety information. We strongly encourage you to read and apply them.

# IMPORTANT SAFETY INSTRUCTIONS

**WHEN INSTALLING AND USING THIS ELECTRICAL EQUIPMENT, BASIC SAFETY PRECAUTIONS SHOULD ALWAYS BE FOLLOWED, INCLUDING THE FOLLOWING:**

## 1. READ AND FOLLOW ALL INSTRUCTIONS

2. **WARNING:** To reduce the risk of injury, do not permit children to use this product unless closely supervised at all times.
3. **DANGER: RISK OF CHILD DROWNING.** Extreme caution must be exercised to prevent unauthorized access by children. To avoid accidents, ensure that children cannot use the spa or hot tub unless they are supervised at all times.

## 120 VOLT, CORD CONNECTED MODELS

4. **DANGER: RISK OF INJURY.** Connect only to a grounded source.
5. Do not bury the power cord.
6. **WARNING:** To reduce the risk of electric shock, replace a damaged cord immediately.
7. A ground terminal (pressure wire connector) is provided on the surface of the control box inside the equipment compartment. This connector should be bonded with a minimum No. 8 AWG (8.4mm<sup>2</sup>) (No. 6 AWG in Canada) solid copper wire between this unit and any metal ladders, metal water pipes, metal enclosures of electrical equipment, conduit, or metal equipment within five feet (1.5m) of the spa. If the spa is located on a reinforced concrete pad, the reinforced steel should also be bonded to the ground terminal.
8. **WARNING:** Your spa may be equipped with a ground fault circuit interrupter (GFCI) on the end of the power supply cord. Before each use of the spa, with the plug connected to the power supply and the unit operating, press the "test" button. The unit should stop operating and the GFCI power indicator will go out. Wait thirty seconds and then reset the GFCI by pressing the "Reset" button. The GFCI power indicator will turn on, restoring power to the spa. If the interrupter does not perform in this manner, it is an indication of an electrical malfunction and the possibility of an electric shock. Disconnect the plug from the receptacle until the fault has been identified and corrected.

### 240 VOLT, PERMANENTLY INSTALLED OR CONVERTED MODELS

9. A ground terminal is provided on the terminal block (TB-1, terminal 7) located inside the control box. To reduce the risk of electric shock, connect this terminal to the grounding terminal of your electrical service or supply panel with a continuous green, insulated copper wire. The wire must be equivalent in size to the circuit conductors supplying the equipment. In addition, a bonding terminal (pressure wire connector) is provided on the outside of the control box for bonding to local ground points. To reduce the risk of electric shock, this connector should be bonded with a No. 8 AWG (8.42mm<sup>2</sup>) (No. 6 AWG in Canada) solid copper wire to any metal ladders, water pipes, or other metal within five feet (1.5m) of the spa to comply with local requirements.
10. Your spa uses ground fault circuit interrupters in the electrical sub-panel. Before each use of the spa and with the unit operating press the Test button on each breaker. The switch should click over to the "Trip" position. Wait thirty seconds and reset each GFCI breaker by switching it completely off and then completely on. The switch should then stay on. If either of the interrupters does not perform in this manner, it is an indication of an electrical malfunction and the possibility of an electric shock. Disconnect the power until the fault has been identified and corrected.

### ALL SPA MODELS

11. Install the spa so proper drainage is provided.
12. **DANGER: RISK OF ELECTRIC SHOCK.** Install the spa at least five feet (1.5m) away from metal surfaces, in accordance with the National Electric Code ANS/NMFFPA70-1993. Each metal surface must be permanently connected to a minimum No. 8 (8.42mm<sup>2</sup>) (No. 6 AWG in Canada) solid copper conductor attached to the wire bonding connector on the terminal box provided for this purpose.
13. **DANGER: RISK OF ELECTRIC SHOCK.** Do not permit any appliance, such as a light, telephone, radio, or television, etc. within five feet (1.5m) of the spa or hot tub.
14. **WARNING:** To reduce the risk of injury:
  - Water temperatures between 100°F (38°C) and 104°F (40°C) are considered safe for a healthy adult. Lower water temperatures are recommended for extended use (exceeding 10 minutes) and for young children.
  - Since excessive water temperatures have a high potential for causing fetal damage during the early months of pregnancy, pregnant or possibly pregnant women should limit spa water temperatures to 100°F (38°C).
  - Before entering a spa, the user should measure the water temperature with an accurate, waterproof, fever thermometer since the tolerance of temperature-regulating devices may vary as much as +/- 5°F (3°C).
  - The use of drugs, alcohol, or medication before or during spa use may lead to unconsciousness with the possibility of drowning.

- Persons suffering from obesity or with a medical history of heart disease, low or high blood pressure, circulatory system problems, or diabetes should consult a physician before using the spa.
  - Persons using medications should consult a physician before using a spa since some medication may induce drowsiness while other medication may affect heart rate, blood pressure, and circulation.
15. **DANGER: TO REDUCE THE RISK OF INJURY TO PERSONS.**  
Do not remove the suction fittings.
  16. **DANGER: RISK OF INJURY:** Never operate a spa if the suction guard(s) is broken or missing. Never replace a suction guard with one rated less than the flow rate marked on the original suction guard. The suction guard(s) in the spa are sized to match the specific water flow created by the pump. Should the need arise to replace the suction guard(s) or the pump, be sure that the flow rates are compatible.
  17. **DANGER:** Children are especially sensitive to hot water. At no time should children have unsupervised access to the spa. Children must not be allowed to climb onto the spa cover. All Everyday Hot Tubs are equipped with a locking cover that meets the ASTM F1346-91 Standard for Safety Covers. Always lock the child resistant locks after using the spa for your children's safety.

## 18. **SAVE THESE INSTRUCTIONS.**

**WARNING:** Do not permit electric appliance (such as a light, telephone, radio, or television) within five feet (1.5m) of this spa or hot tub.

**WARNING:** Children should not use spas or hot tubs without adult supervision.

**WARNING:** Do not use spas or hot tubs unless all suction guard(s) are installed to prevent body and hair entrapment.

**WARNING:** Do not use drugs or alcohol before or during the use of a spa or hot tub to avoid unconsciousness and possible drowning.

**WARNING:** People using medications and/or having an adverse medical history should consult a physician before using a spa.

**WARNING:** The use of alcohol, drugs, and medication can greatly increase the risk of fatal hyperthermia.

**WARNING:** Before entering the spa or hot tub measure the water temperature with an accurate thermometer.

**WARNING:** Water temperature in excess of 104°F (40°C) may be injurious to your health.

**WARNING:** Prolonged immersion in a spa or hot tub may be injurious to your health.

**WARNING:** People with infectious diseases should not use a spa.

**WARNING:** Pregnant or possibly pregnant women should consult a physician before using a spa or hot tub.

**WARNING:** To avoid injury, exercise care when entering and exiting the spa or hot tub.

**WARNING:** Do not use a spa or hot tub immediately following strenuous exercise.

**WARNING:** Maintain water chemistry in accordance with manufacturer's instructions.

**SAFETY INSTRUCTIONS FOR FRENCH SPEAKING SPA OWNERS**

**AVERTISSEMENT:** Ne pas placer d'appareil électrique (luminaire, téléphone, radio, téléviseur, etc.) moins de 1.52 m de cette cuve de relaxation.

**AVERTISSEMENT:** Ne pas laisser les enfants utiliser une cuve de relaxation sans surveillance.

**AVERTISSEMENT:** Pour éviter que les cheveux ou une partie du corps puissent être aspirés, ne pas utiliser une cuve de relaxation si les grilles de prise d'aspiration ne sont pas toutes en place.

**AVERTISSEMENT:** Pour éviter l'évanouissement et la noyade éventuelle, ne prendre ni drogue ni alcool avant d'utiliser une cuve de relaxation ni quand on s'y trouve.

**AVERTISSEMENT:** Les personnes qui prennent des médicaments ou ont des problèmes de santé devraient consulter un médecin avant d'utiliser une cuve de relaxation.

**AVERTISSEMENT:** La consommation d'alcool ou de drogue augmente considérablement les risques d'hyperthermie motrice dans une cuve de relaxation.

**AVERTISSEMENT:** Avant d'utiliser une cuve de relaxation mesurer la température de l'eau l'aide d'un thermomètre précis.

**AVERTISSEMENT:** Il peut être dangereux pour la santé de se plonger dans de l'eau plus de 40°C.

**AVERTISSEMENT:** L'utilisation prolongée d'une cuve de relaxation peut être dangereuse pour la santé.

**AVERTISSEMENT:** Les personnes atteintes de maladies infectieuses ne devraient pas utiliser une cuve de relaxation.

**AVERTISSEMENT:** Les femmes enceintes, que leur grossesse soit confirmée ou non, devraient consulter un médecin avant d'utiliser une cuve de relaxation.

**AVERTISSEMENT:** Pour éviter des blessures, user de prudence en entrant dans une cuve de relaxation et en sortant.

**AVERTISSEMENT:** Ne pas utiliser une cuve de relaxation immédiatement après un exercice fatigant.

**ATTENTION:** La teneur de l'eau en matières dissoutes doit être conforme aux directives du fabricant.

### PERSONAL SAFETY

Prolonged immersion in hot water can result in **HYPERTHERMIA**, a dangerous condition which occurs when the internal temperature of the body reaches a level above normal (98.6°F, 37°C). The symptoms of hyperthermia include dizziness, fainting, drowsiness, lethargy, and a body temperature above 98.6°F (37°C). The physical effects of hyperthermia include unawareness of impending hazard, failure to perceive heat, failure to recognize the need to exit the spa, physical inability to exit the spa, fetal damage in pregnant women, and unconsciousness resulting in a danger of drowning.

**WARNING:** The use of alcohol, drugs, or medication can greatly increase the risk of fatal hyperthermia in hot tubs and spas.

Persons taking medications which induce drowsiness such as tranquilizers, antihistamines, or anticoagulants should not use the spa. Pregnant women and persons with a medical history of heart disease, diabetes, or high blood pressure should consult a physician before using the spa.



### PERSONAL SAFETY DOs:

- Be sure your spa is connected to the power supply correctly – only use a licensed electrical contractor.
- Shut off power supply (unplug 120V models) before draining the spa or servicing the electrical components.
- Test the Ground Fault Circuit Interrupter (GFCI) monthly.
- Always test the water temperature with an accurate thermometer before entering the spa to be sure that it's a safe temperature.
- Remember that wet surfaces can be very slippery. Take care when entering and exiting the spa.
- Lock the spa cover when the spa is not in use, whether it is empty or full of water.
- Keep the water clean and sanitized with correct chemical care.
- Turn on the jets when adding ANY chemicals to the spa water.
- Clean the filter cartridge monthly to remove debris and mineral buildup which affects the performance of the hydrotherapy jets, limits the flow, or trips the high limit thermostat which will turn off the entire spa.

### PERSONAL SAFETY DO NOTs:

- Don't use the spa with the equipment compartment door removed.
- Don't use the spa for more than 10 minutes of time at water temperatures in excess of 102°F (39°C).
- Don't allow the jet pump to operate for an extended period of time with the cover in place. Extended pump operation causes a slow heat buildup due to water friction. The spa equipment controls are equipped with a built-in safety timer that automatically shuts off the jet pump after 15 minutes of continuous operation should it have been left on inadvertently.
- Don't operate the spa at any time with the filter cartridges removed.
- Don't lift or drag the cover by using the tie-down straps; always lift and carry by using the external handles.
- Don't store chemicals in the spa's equipment compartment.
- Don't hesitate to call your authorized dealer with any questions or maintenance concerns.

### LOCATION

For your portable spa to function properly and safely, it must be located on a hard, flat, level surface. Inground spas require special installation techniques and should be planned in conjunction with your spa dealer. Improper installation can result in structural damage to the spa and the voiding of your spa warranty. Items to discuss with your dealer include: local construction codes; electrical service requirements; serviceability of equipment; present underground obstructions such as gas, water, and telephone lines; safety measures such as fences and locks; and visibility of the spa installation from the home, street, and neighbors.

- Allow for sufficient water drainage around the spa to help preserve the equipment and support structure. This includes indoor installations.
- A filled spa can weigh in excess of 4,000 pounds and the location should support the weight of the filled spa.
- Locate the equipment compartment where it will be accessible. Your spa **MUST** be installed to permit access for servicing the equipment above and/or below any decks or floors. Access is essential and must allow adequate room for service.
- Leave access to the circuit breakers in the sub panel (240V models) or to the interrupter switch (GFCI, 120V models) on the end of the power cord.
- Be sure the spa is level and in the final position **BEFORE** filling with water. Check for power cords, tools, and hoses that may be caught underneath the spa.
- **IMPORTANT: DO NOT LET AN EMPTY SPA REMAIN EXPOSED TO DIRECT SUNLIGHT.** Spa surface temperatures can reach in excess of 150°F (65°C) if left exposed to the sun. Significant damage can occur if this is allowed to happen, including warping and blistering of the surface. Damage, that occurs as a result of this exposure is not covered under the warranty.
- **CAUTION:** Never try to move a spa that has not been fully drained. To do so could result in damage to the spa and physical injury to the mover.

### OUTDOOR AND PATIO INSTALLATION

To install the spa outdoors, we recommend a reinforced concrete pad at least four inches thick. The reinforcing material should be attached to a #8 AWG bonding wire per national and local electrical code.

If you place the spa on the ground, even temporarily, place concrete pavers under the entire bottom of the spa. The concrete pavers should be at least two inches thick and level across the entire surface. The spa will inevitably settle and not remain level on this surface, thus it's important to get it onto a solid foundation as soon as possible.

### DECK INSTALLATION

Be sure the deck can support the weight of your filled spa by checking the deck's maximum load capacity. Consult a qualified building contractor or structural engineer. Minimum requirement is 100 pounds per square foot.

### INDOOR INSTALLATION

There are special requirements if you place your spa indoors. Flooring material must provide adequate traction when wet. Proper drainage is essential to prevent water puddling. Proper ventilation to the area is required. The addition of a ventilation system is recommended. Please see your contractor for details.



### SHUT-OFF VALVES

Your spa is equipped with shut-off valves (see EQUIPMENT DIAGRAM) that shut off the water flow to the equipment system for dealer service. At times, a new spa or one that has recently been serviced, may have the shut-off valves partially closed which can restrict the water flow and hinder jet performance. Be sure the valves are fully open.



Shut-off valve in open position

### FREEZE PROTECTION

When a freeze condition is detected (which occurs when the temperature in the heater housing drops to 55°F (13°C) the jet pump is automatically activated. In areas with extremely cold winter conditions, your spa should be fine as long as it is left running at normal operating temperatures. For extra protection see your dealer for an optional freeze sensor. If you plan to turn the spa off, follow the instructions in this manual (see SUSPENDED USE OR WINTERIZING YOUR SPA).

### OVERHEATING

In the case of extended hot weather, the spa water temperature may reach and maintain 104°F to 106°F (40°C to 41°C) or higher. This is due to the ambient temperature and the full insulation in the spa cabinet. You may have the option of shortening the pump-run time. See SPA CONTROL OPERATION for available options.

### FILTER CARTRIDGE

Your portable spa is equipped with the Constant-Clean™ Filtration system.

**NOTE:** It is very important that the components of these filtration systems be installed properly in the proper part of the spa.



1) Center filter cartridge over canister



2) Screw filter cartridge in place



3) Snap Vortex filter top in place

1. Hold the Vortex filter cartridge and center it in the opening of the filter housing.
2. Use the filter handle and turn the filter cartridge clockwise to screw it in place. (Use caution not to overtighten as damage may occur to threads and is not covered under warranty.)
3. Grasp the edge of the dome-shaped Vortex filter top. Center it over the ring and gently snap in place.



Safety guard of suction fitting must remain in place.

## SUCTION GUARDS

The suction guard(s) in the footwell of your spa is an opening through which the jet pump draws water. Suction fittings are equipped with a safety guard. Suction through the fittings can be strong. The safety guard(s) must remain in place and undamaged. A fitting with a damaged guard(s) can be dangerous, especially to small children or people with long hair. Should any part of the body become drawn to a fitting, turn the jet pump off immediately. Long hair should be restrained in a bathing cap, never allow it to float freely in the spa. Replace any missing or damaged suction guard(s).

**NOTE:** It is normal for the flow rates of the suction fittings to vary from strong to barely noticeable.

## ELECTRICAL REQUIREMENTS

It is the responsibility of the spa owner to ensure that all electrical connections are made by a qualified electrician in accordance with all national, state, and local electrical codes in effect at the time of installation.

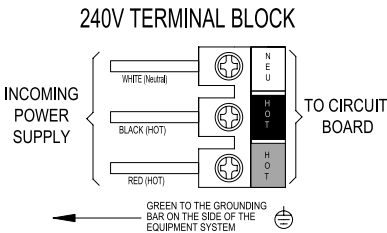

### 240 Volt

All connections must be made in accordance with the wiring diagram found on the inside of the control box cover. Connections must be made with copper conductors only – *do NOT use aluminum wire*. All conductors, circuit breakers, and fuses and the GFCI must be sized in accordance to the total amperage load as specified:

- Permanently connected (Hard wired).
- Rated 240V, 60Hz, 50A, three wires (#6 copper) plus ground (#8 copper), [4 wires total].
- Circuit breaker or fuse size: 50A.
- A disconnecting means must be installed within sight from the equipment and at least 5 feet (1.52m) from the inside walls of the spa.
- Connect only to a circuit protected by a Class A Ground Fault Circuit Interrupter (GFCI).
- For units used in other than single-family dwellings, a clearly labeled emergency switch shall be provided as part of the installation. The switch shall be readily accessible to the occupants and shall be installed at least five feet (1.52 m) away, adjacent to, and within sight of the unit.
- A pressure wire connector is provided on the exterior of the control box to allow connection of a bonding wire to any metal ladder, metal water pipe, common bonding grid (reinforced concrete slab, ground plate beneath the spa), or any other metal within 5 feet (1.52 m) of the spa. The bonding wire shall be copper and at least #8 AWG (8.42mm<sup>2</sup>), #6 in Canada.

## installation instructions

**NOTE:** Ensure that a Ground Fault Circuit Interrupter (GFCI) is properly installed. Failure to do so may result in spa malfunction or damage which is not warranted. GFCIs are available from your authorized dealer.

### 120 Volt

120 Volt spas shall be plugged into a properly grounded, grounding type 15 amp receptacle on a dedicated circuit. A dedicated circuit is a circuit with no other components that consume power, such as lights, televisions, radios, computers, or other electronic devices. These could cause your spa to malfunction by any of the following: unusual text on the control panel, slow heating, poor jet action, tripping house breaker, or blown fuses. Failure to follow these instructions could lead to premature failure of spa components that would not be covered under the warranty. The dedicated circuit shall meet the following specifications:

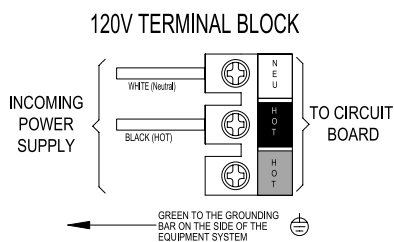

- Rated 120V, 60Hz, 15A (2 wires plus ground)
- Circuit breaker or fuse size: 15A
- The receptacle must be at least 5 feet (1.52 m) from the spa.
- The 15 foot GFCI power cord provided with the spa must be plugged directly into the receptacle. Do NOT use an extension cord or any other adaptor. Actual exposed length of cord will vary by model, but will never be less than 12 feet.

### Convert 120 Volt to 240 Volt

120 Volt spas may be converted to operate on 240V, 50A. All connections must be made by a licensed electrician.

1. Disconnect the power by unplugging the power cord from the receptacle, removing the cord from the terminal block on the circuit board, and storing it with your owner's manual.
2. Locate the white wire connecting J11 to J32 on the circuit board. Remove the wire and discard.
3. For 50A operation, move dip switch 10 to the OFF position.
4. Install 240V power as indicated in the **240 Volt** section.
5. Rated 240V, 60Hz, 50A, three wires (#6 copper) plus ground (#8 copper), [4 wires total].

### START-UP PROCEDURE

Your spa is equipped with solid-state Comfort Controls specific to your spa model. Please see SPA CONTROL OPERATION.

To start your spa, you need the water test strips in the chemical kit provided iwth your spa. It is important to follow each of these steps when starting your spa. Once you have completed the following steps, refer to the WATER TREATMENT section for proper start-up water maintenance.

**NOTE:** Your spa has been filled and test-run at the factory. The first time your spa is filled with water, some discoloration from residual test water may appear. This will disappear when the spa is completely filled and the filtration system is functioning. Test the water for the proper chemical balance and adjust as necessary. **PROPER CHEMICAL BALANCE IS IMPORTANT** for your safety and the longevity of your spa.

### THERAPY PUMP

Allow the spa to circulate on high-speed (see SPA CONTROL OPERATION) for four to five minutes to discharge air from the plumbing system. Do not expect hot water immediately from the jets; the heater will take several hours to heat the water.

### Start-up procedure for all models

1. Place spa on a hard, flat, level surface. Make sure the power supply is off.
2. Make sure the suction guard(s) in the footwell are in place and undamaged.
3. Open the equipment door. (SEE EQUIPMENT DIAGRAM). Tighten all disconnects and open all shut-off valves.

**NOTE:** Keep the drain valve closed at all times except when draining the spa (do not rely on the cap to stop the flow of water). Not doing so could result in damage to the drain valve due to freezing water.

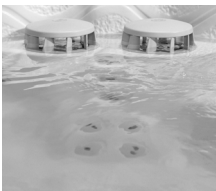

Fill spa with water to two-thirds of the way up the Vortex skimmer opening.

4. Install filter cartridge. (See INSTALLATION INSTRUCTIONS, Filter Cartridge(s).)
5. Fill the spa with water to two-thirds of the way up the Vortex skimmer openings. The use of a *Fill Filter* is recommended, especially in areas with high mineral content in the water.



Use TEMP± pad to set water temperature.



Spa cover helps maintain a constant water temperature.

6. Turn the power on.
7. Your spa is now in “pump priming” mode and a “Pr” message displays in the LCD window of the control panel. While in this mode the spa appears idle, which lasts approximately four to five minutes if not exited manually. To exit manually, press the TEMP± pad.
8. At this time the spa should have water flowing from the jets. If the pump has not primed and the water is not flowing from the jets after two minutes **TURN OFF POWER TO THE SPA** and vent air from the pumps by slightly opening the pump unions. After turning the power on again, the spa initiates a new priming mode. Repeat steps above.
9. The system requires approximately two minutes of water flow to determine the water temperature. After two minutes of water flow, the temperature is displayed as actual water temperature. After you have manually exited the priming mode (or allowed the spa to automatically exit) the LCD window momentarily displays 102°F (39°C) and then the display switches to - - °F.
10. The factory default setting for water temperature is 102°F (39°C). Use the TEMP± pad on the control panel to set the water temperature to the desired level. (See SPA CONTROL OPERATION, Temperature Display And Adjustment.) Your spa heats at the rate of approximately one degree per hour for 120V systems, and five degrees per hour for 240V systems.

### SPA COVER

When the spa is not in use, the spa cover should be kept on the spa to retain the water's heat and to keep out dirt, leaves, etc. Your heater maintains a constant water temperature between uses.

For your safety and convenience, the cover is equipped with adjustable straps, safety locks, and handles. Use the exterior handles to remove and replace your cover. We suggest that you use the safety locks to help keep out unintended users and prevent the cover from being blown off in windy conditions.



### MAXIMUM THERAPY JETTING SYSTEM

#### HK™8 NECK JETS

The neck jets are turned on and off (when the jet pump is on) using the small teardrop neck jet control lever.

#### HK™12 JETS

This small jet provides a targeted stream of water.

#### HK™16 JETS

The direction of water flow can be changed by redirecting the central nozzle. The water flow can be adjusted by turning the jet face using the four tabs.

#### HK™40 JET

High-flow jet strategically positioned within the spa to provide passive and whole body massage.

#### HK™8 NECK JET CONTROL

Use this control to increase or decrease the air flow to the neck jets.

**5** Use the Bather's panel to set the temperature, select the filtration, and turn on the jets and lights.

**11** This valve controls the water flow of the neck jets.

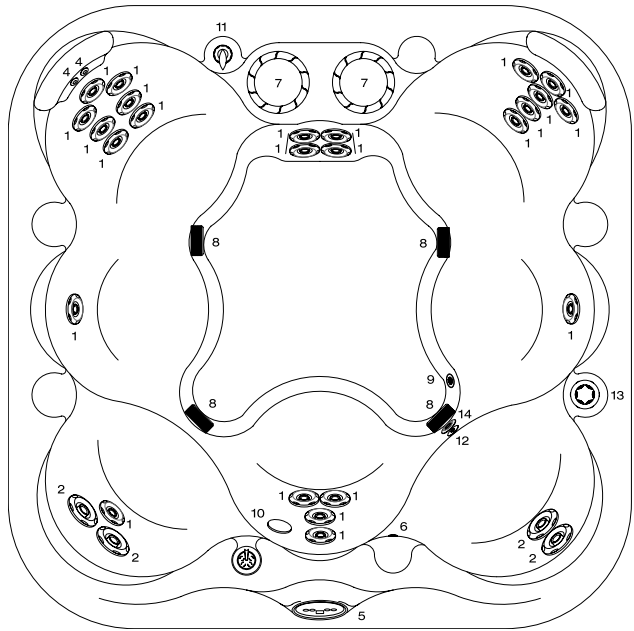

#	Component Identification	Qty.
1	HK™12 Jets	24
2	HK™16 Jets	4
4	HK™8 Neck Jets	2
5	Bathers Control Panel	1
6	IR Sensor	1
7	Filter Canisters	2
8	Suction Fittings	4
9	Floor Drain	1
10	Light	1
11	Neck Jet Valve	1
12	Ozone Injector Fitting	1
13	Spa Frog®	1
14	Spa Frog® Return Fitting	1

Physical Specifications	Size
Dimensions	84" x 84"
Height	34"
Interior Depth	32.5"
Seating Capacity/Positions	6/7
Weight Dry/Lbs.	780
Weight Full/Lbs.	4032
Water Capacity/Gallons	390
Total Therapy Jets	30

**5** Use the Bather's panel to set the temperature, select the filtration, and turn on the jets and lights.

**11** This valve controls the water flow of the neck jets.

**16** Use PowerShift control to select jet zones.

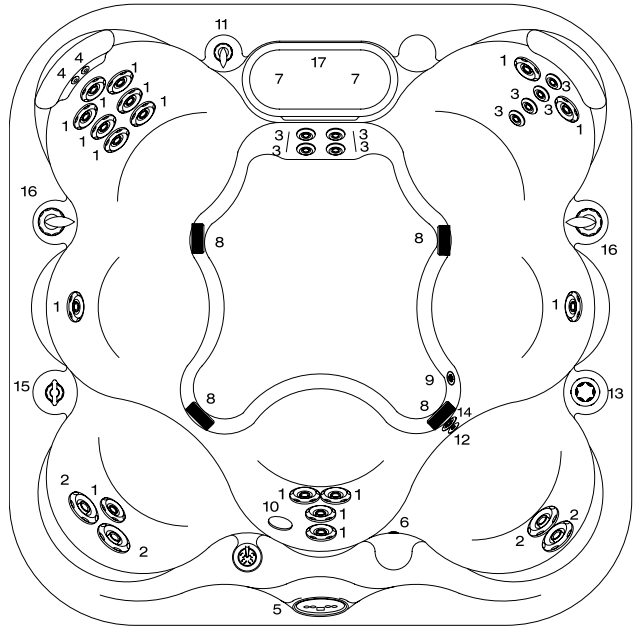

#	Component Identification	Qty.
1	HK™12 Jets	16
2	HK™16 Jets	4
3	HK™40 Jets	8
4	HK™8 Neck Jets	2
5	Bathers Control Panel	1
6	IR Sensor	1
7	Filter Canisters	2
8	Suction Fittings	4
9	Floor Drain	1
10	Light	1
11	Neck Jet Valve	1
12	Ozone Injector Fitting	1
13	Spa Frog®	1
14	Spa Frog® Return Fitting	1
15	Waterfall Valve	1
16	PowerShift™ Controls	2
17	Waterfall Feature	1
Physical Specifications		Size
Dimensions		84" x 84"
Height		34"
Interior Depth		32.5"
Seating Capacity/Positions		6/7
Weight Dry/Lbs.		780
Weight Full/Lbs.		4032
Water Capacity/Gallons		390
Total Therapy Jets		30

**ZONE 2A**

Upper-, mid- and lower-back jets.\*

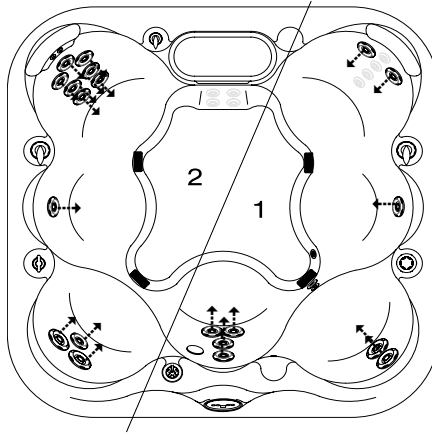

**ZONE 1A**

Mid-, lower-back and leg jets.\*



**ZONE 2B**

Lower-body jets.\*

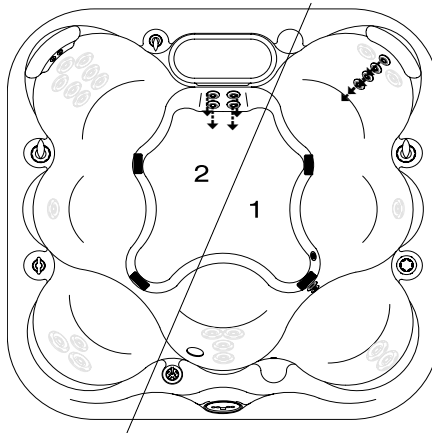

**ZONE 1B**

Upper- and mid-back jets.\*



\*Neck jets operate in zone 2.

\*Waterfall operates in zone 1.

**5** Use the Bather's panel to set the temperature, select the filtration, and turn on the jets and lights.

**11** This valve controls the water flow of the neck jets.

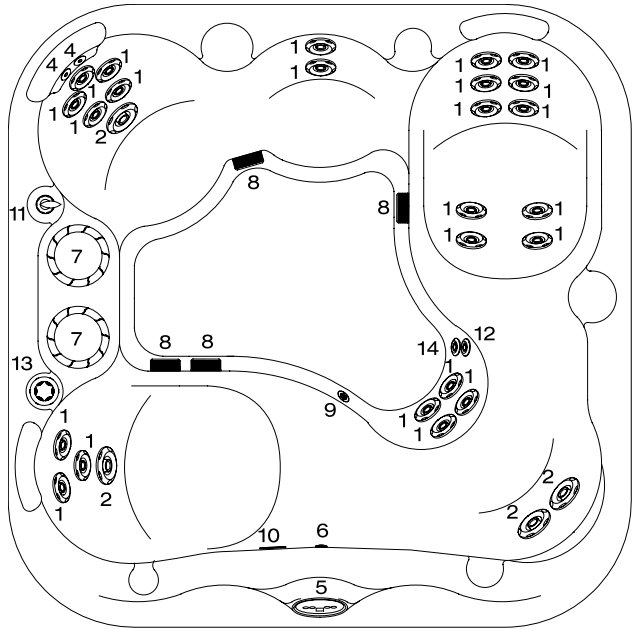

#	Component Identification	Qty.
1	HK™12 Jets	24
2	HK™16 Jets	4
4	HK™8 Neck Jets	2
5	Bathers Control Panel	1
6	IR Sensor	1
7	Filter Canisters	2
8	Suction Fittings	4
9	Floor Drain	1
10	Light	1
11	Neck Jet Valve	1
12	Ozone Injector Fitting	1
13	Spa Frog®	1
14	Spa Frog® Return Fitting	1

Physical Specifications	Size
Dimensions	84" x 84"
Height	34"
Interior Depth	32.5"
Seating Capacity/Positions	5
Weight Dry/Lbs.	780
Weight Full/Lbs.	3699
Water Capacity/Gallons	350
Total Therapy Jets	30

**5** Use the Bather's panel to set the temperature, select the filtration, and turn on the jets and lights.

**11** This valve controls the water flow of the neck jets.

**16** Use PowerShift control to select jet zones.

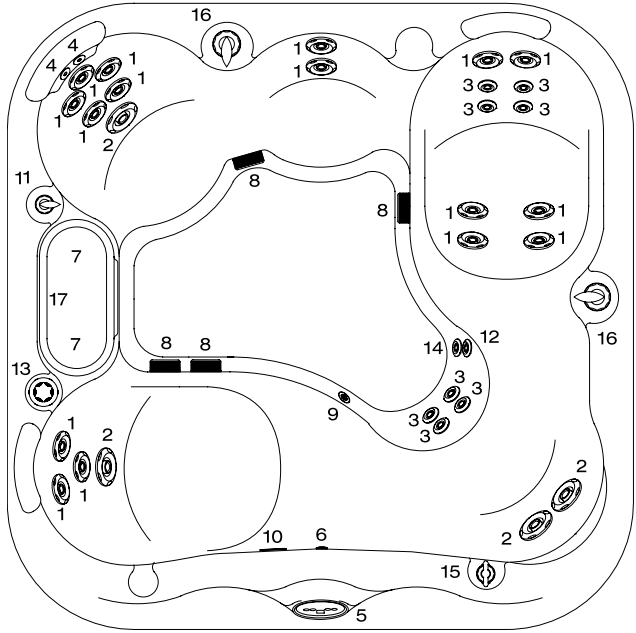

#	Component Identification	Qty.
1	HK™12 Jets	16
2	HK™16 Jets	4
3	HK™40 Jets	8
4	HK™8 Neck Jets	2
5	Bathers Control Panel	1
6	IR Sensor	1
7	Filter Canisters	2
8	Suction Fittings	4
9	Floor Drain	1
10	Light	1
11	Neck Jet Valve	1
12	Ozone Injector Fitting	1
13	Spa Frog®	1
14	Spa Frog® Return Fitting	1
15	Waterfall Valve	1
16	PowerShift™ Controls	2
17	Waterfall Feature	1
Physical Specifications		Size
Dimensions		84" x 84"
Height		34"
Interior Depth		32.5"
Seating Capacity/Positions		5
Weight Dry/Lbs.		780
Weight Full/Lbs.		3699
Water Capacity/Gallons		350
Total Therapy Jets		30

**ZONE 2A**

Upper-, mid- and lower-back jets.\*

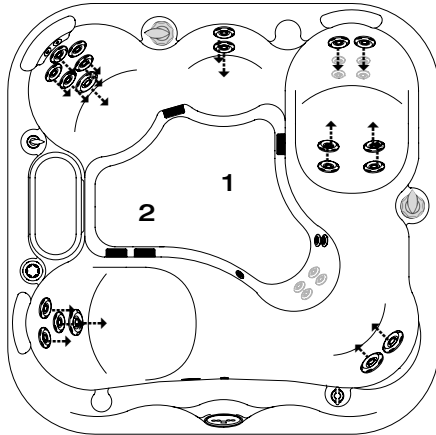

**ZONE 1A**

Mid-, lower-back and leg jets.\*



**ZONE 2B**

Lower-body jets.\*

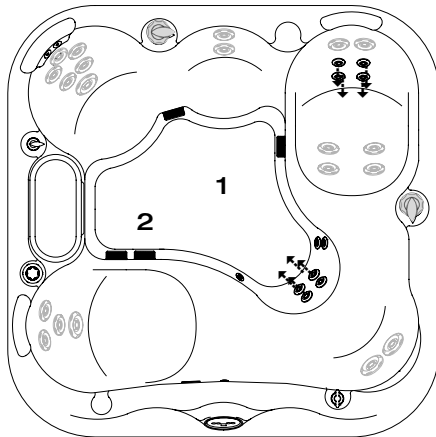
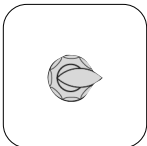

**ZONE 1B**

Upper- and mid-back jets.\*



\*Neck jets operate in zone 2.

\*Waterfall operates in zone 1.

**5** Use the Bather's panel to set the temperature, select the filtration, and turn on the jets and lights.

**11** This valve controls the water flow of the neck jets.

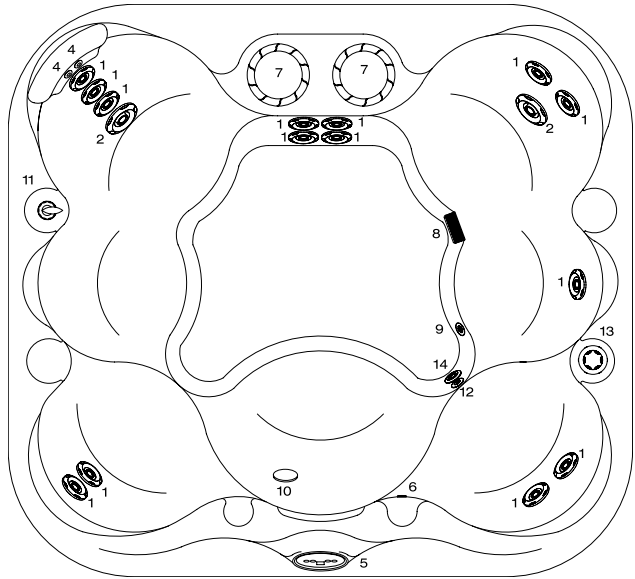

#	Component Identification	Qty.
1	HK™12 Jets	14
2	HK™16 Jets	2
4	HK™8 Neck Jets	2
5	Bathers Control Panel	1
6	IR Sensor	1
7	Filter Canisters	2
8	Suction Fitting	1
9	Floor Drain	1
10	Light	1
11	Neck Jet Valve	1
12	Ozone Injector Fitting	1
13	Spa Frog®	1
14	Spa Frog® Return Fitting	1
Physical Specifications		Size
Dimensions		77" x 84"
Height		34"
Interior Depth		32.5"
Seating Capacity/Positions		4/7
Weight Dry/Lbs.		600
Weight Full/Lbs.		3436
Water Capacity/Gallons		340
Total Therapy Jets		18



**5** Use the Bather's panel to set the temperature, select the filtration, and turn on the jets and lights.

**11** This valve controls the water flow of the neck jets.

**16** Use PowerShift control to select jet zones.

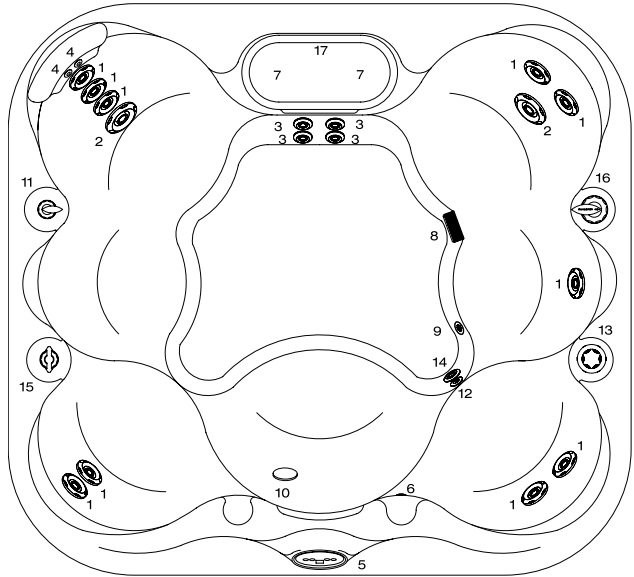

#	Component Identification	Qty.
1	HK™ 12 Jets	10
2	HK™ 16 Jets	2
3	HK™ 40 Jets	4
4	HK™ 8 Neck Jets	2
5	Bathers Control Panel	1
6	IR Sensor	1
7	Filter Canisters	2
8	Suction Fitting	1
9	Floor Drain	1
10	Light	1
11	Neck Jet Valve	1
12	Ozone Injector Fitting	1
13	Spa Frog®	1
14	Spa Frog® Return Fitting	1
15	Waterfall Valve	1
16	PowerShift™ Control	1
17	Waterfall Feature	1

Physical Specifications	Size
Dimensions	77" x 84"
Height	34"
Interior Depth	32.5"
Seating Capacity/Positions	4/7
Weight Dry/Lbs.	600
Weight Full/Lbs.	3436
Water Capacity/Gallons	340
Total Therapy Jets	18

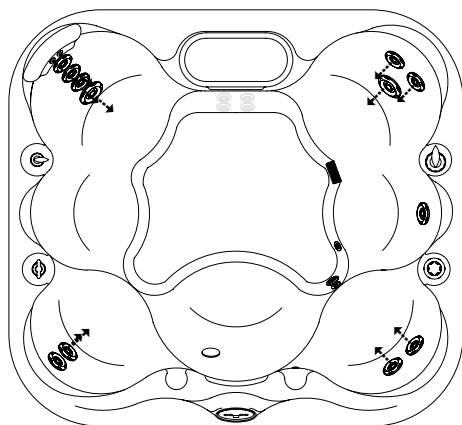

**ZONE 2**

Upper-, mid- and lower-back jets.\*

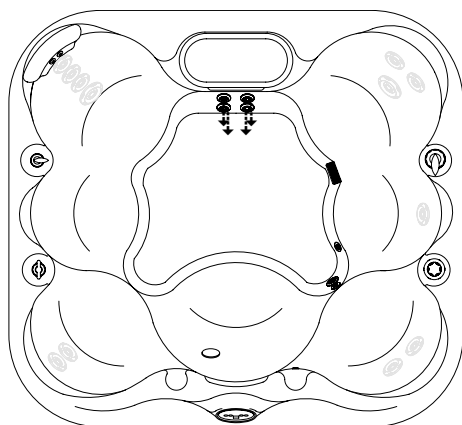

**ZONE 1**

Lower-body jets.\*

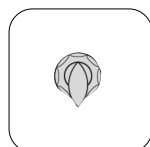

\*Neck jets operate in zone 2.

Waterfall operates in zone 1.

**5** Use the Bather's panel to set the temperature, select the filtration, and turn on the jets and lights.

**11** This valve controls the water flow of the neck jets.

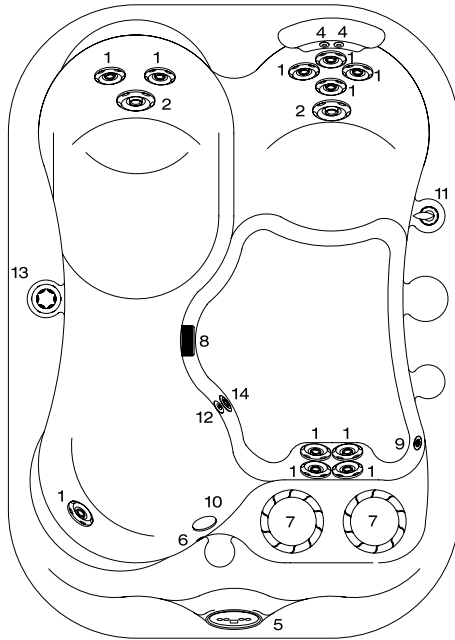

#	Component Identification	Qty.
1	HK™ 12 Jets	11
2	HK™ 16 Jets	2
4	HK™ 8 Neck Jets	2
5	Bathers Control Panel	1
6	IR Sensor	1
7	Filter Canisters	2
8	Suction Fitting	1
9	Floor Drain	1
10	Light	1
11	Neck Jet Valve	1
12	Ozone Injector Fitting	1
13	Spa Frog®	1
14	Spa Frog® Return Fitting	1
Physical Specifications		Size
Dimensions		60" x 84"
Height		29.5"
Interior Depth		28"
Seating Capacity/Positions		3/4
Weight Dry/Lbs.		400
Weight Full/Lbs.		2026
Water Capacity/Gallons		195
Total Therapy Jets		15

**5** Use the Bather's panel to set the temperature, select the filtration, and turn on the jets and lights.

**11** This valve controls the water flow of the neck jets.

**16** Use PowerShift control to select jet zones.

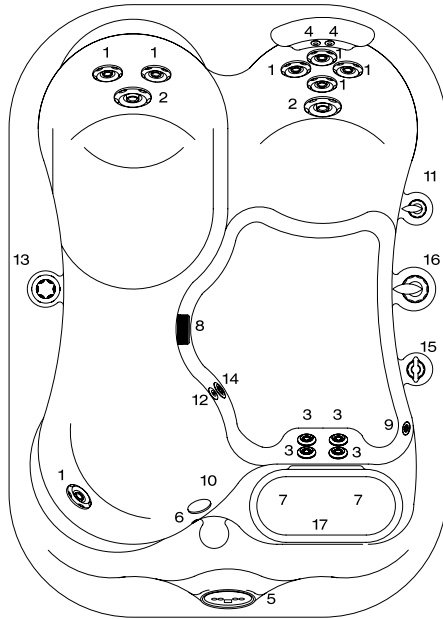

#	Component Identification	Qty.
1	HK™ 12 Jets	7
2	HK™ 16 Jets	2
3	HK™ 40 Jets	4
4	HK™ 8 Neck Jets	2
5	Bathers Control Panel	1
6	IR Sensor	1
7	Filter Canisters	2
8	Suction Fitting	1
9	Floor Drain	1
10	Light	1
11	Neck Jet Valve	1
12	Ozone Injector Fitting	1
13	Spa Frog®	1
14	Spa Frog® Return Fitting	1
15	Waterfall Valve	1
16	PowerShift™ Control	1
17	Waterfall Feature	1
Physical Specifications		Size
Dimensions		60" x 84"
Height		29.5"
Interior Depth		28"
Seating Capacity/Positions		3/4
Weight Dry/Lbs.		400
Weight Full/Lbs.		2026
Water Capacity/Gallons		195
Total Therapy Jets		15

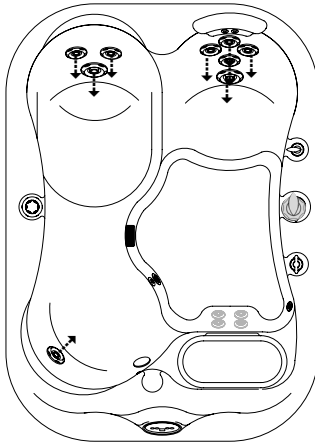

**ZONE 2**  
Upper-,  
mid- and  
lower-back  
jets.\*

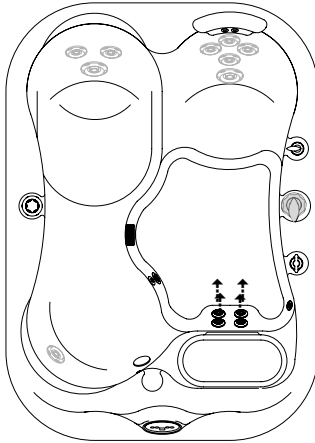

**ZONE 1**  
Lower-  
body jets.\*



\*Neck jets  
operate in  
zone 2.

- 4** Use the Bather's panel to set the temperature, select the filtration, and turn on the jets and lights.

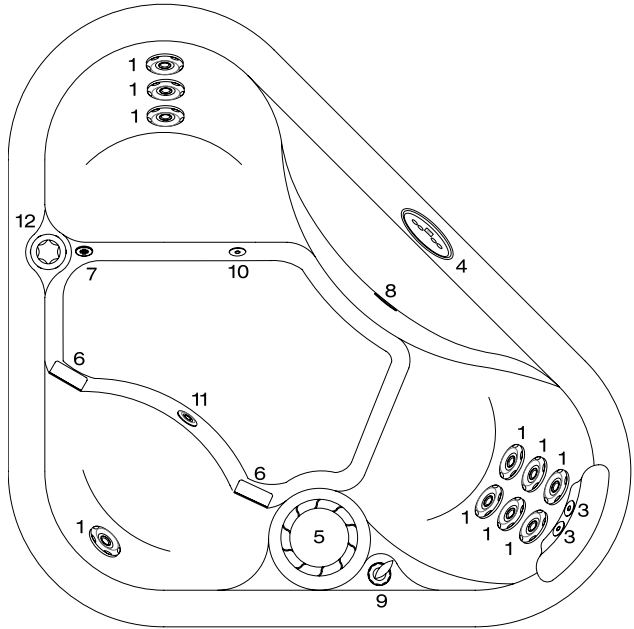

#	Component Identification	Qty.
1	HK™12 Jets	10
3	HK™8 Neck Jets	2
4	Bathers Control Panel	1
5	Filter Canister	1
6	Suction Fittings	2
7	Floor Drain	1
8	Light	1
9	Neck Jet Valve	1
10	Ozone Injector Fitting	1
11	Spa Frog® Return Fitting	1
12	Spa Frog®	1
Physical Specifications		Size
Dimensions		68" x 68"
Height		29.5"
Interior Depth		28"
Seating Positions		3
Weight Dry/Lbs.		300
Weight Full/Lbs.		1545
Water Capacity/Gallons		150
Total Therapy Jets		12

- 4** Use the Bather's panel to set the temperature, select the filtration, and turn on the jets and lights.

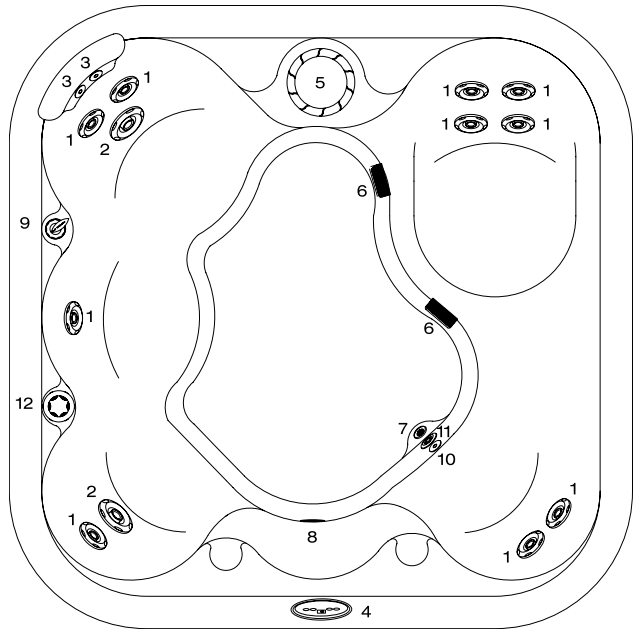

#	Component Identification	Qty.
1	HK™12 Jets	10
2	HK™16 Jets	2
3	HK™8 Neck Jets	2
4	Bathers Control Panel	1
5	Filter Canister	1
6	Suction Fittings	2
7	Floor Drain	1
8	Light	1
9	Neck Jet Valve	1
10	Ozone Injector Fitting	1
11	Spa Frog® Return Fitting	1
12	Spa Frog®	1
Physical Specifications		Size
Dimensions		77" x 77"
Height		29.5"
Interior Depth		28"
Seating Positions		4-5
Weight Dry/Lbs.		475
Weight Full/Lbs.		2977
Water Capacity/Gallons		300
Total Therapy Jets		14

**5** Use the Bather's control panel to set the temperature, select the filtration, and turn on the jets and lights.

**10** This valve controls the water flow of the neck jets.

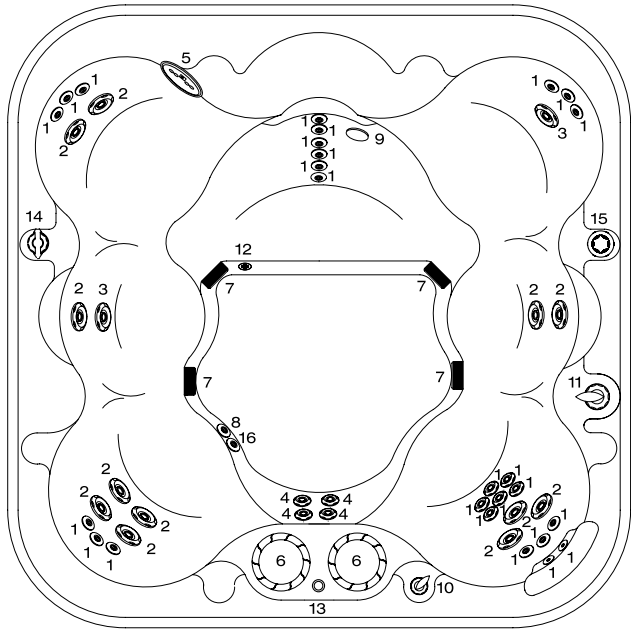

#	Component Identification	Qty.
1	HK™8 Jets	26
2	HK™12 Jets	12
3	HK™16 Jets	2
4	HK™40 Jets	4
5	Bather's Control Panel	1
6	Filter Canisters	2
7	Suction Fittings	4
8	Ozone-ready Injector Fitting	1
9	Light	1
10	Neck Jet Valve	1
11	Jet Selector	1
12	Floor Drain	1
13	Waterfall Feature (option)	1
14	Waterfall Valve (option)	1
15	Spa Frog® Sanitation (option)	1
16	Spa Frog® Return Fitting (option)	1

Physical Specifications	Size
Dimensions	90" x 90"
Height	34"
Interior Depth	32.5"
Seating Capacity/Positions	7
Weight Dry/Lbs.	825
Weight Full/Lbs.	4161
Water Capacity/Gallons	400
Total Therapy Jets	44



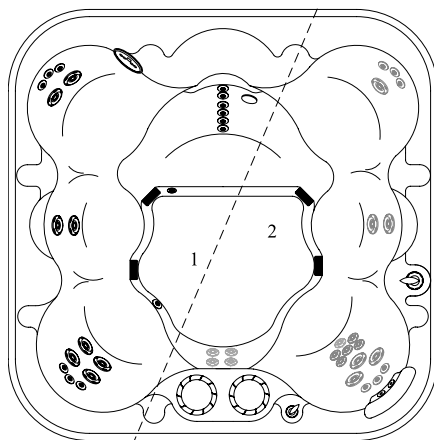

**ZONE 1**

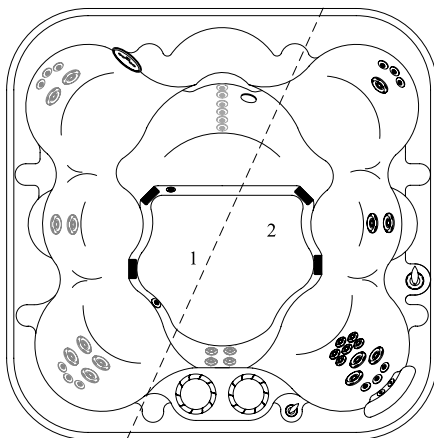

**ZONE 2A**  
Upper,  
mid- and  
lower-body  
jets.\*

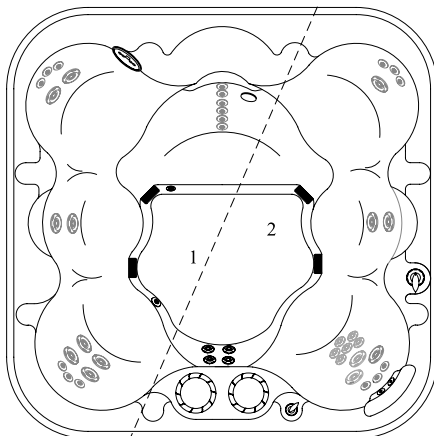

**ZONE 2B**  
Lower-  
back jets.\*

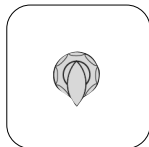

\*Neck jets  
operate in  
all zones.

5 Use the Bather's control panel to set the temperature, select the filtration, and turn on the jets and lights.

10 This valve controls the water flow of the neck jets.

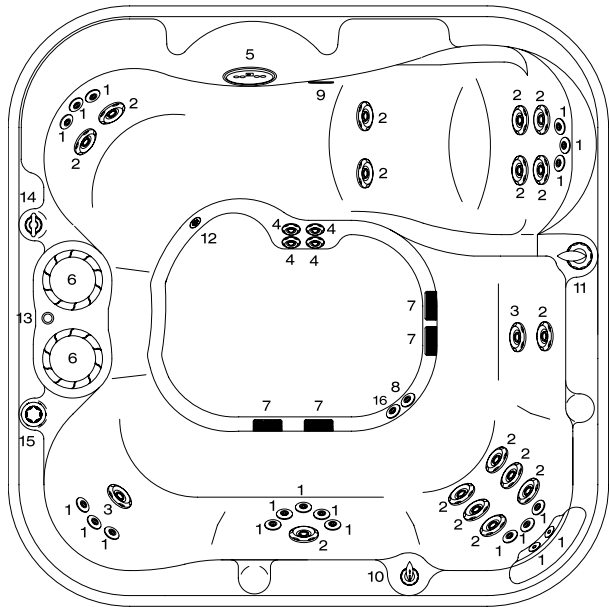

#	Component Identification	Qty.
1	HK™8 Jets	19
2	HK™12 Jets	16
3	HK™16 Jets	2
4	HK™40 Jets	4
5	Bather's Control Panel	1
6	Filter Canisters	2
7	Suction Fittings	4
8	Ozone-ready Injector Fitting	1
9	Light	1
10	Neck Jet Valve	1
11	Jet Selector	1
12	Floor Drain	1
13	Waterfall Feature (option)	1
14	Waterfall Valve (option)	1
15	Spa Frog® Sanitation (option)	1
16	Spa Frog® Return Fitting (option)	1

Physical Specifications	Size
Dimensions	84" x 84"
Height	34"
Interior Depth	32.5"
Seating Capacity/Positions	6
Weight Dry/Lbs.	740
Weight Full/Lbs.	3659
Water Capacity/Gallons	350
Total Therapy Jets	41

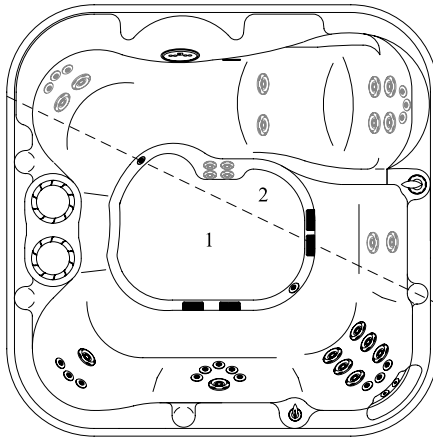

**ZONE 1**

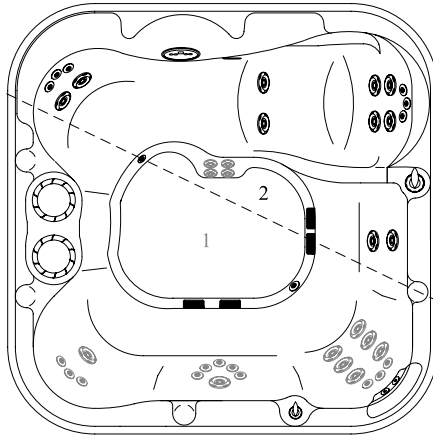

**ZONE 2A**  
Upper- and  
mid- back,  
and leg  
jets.\*

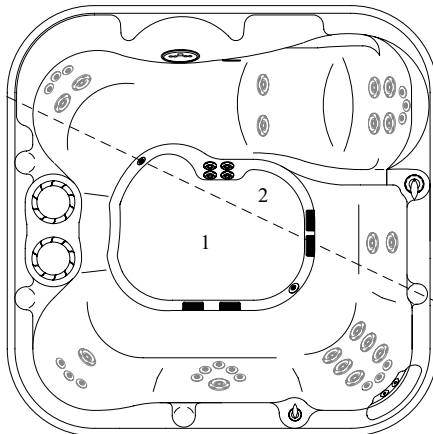
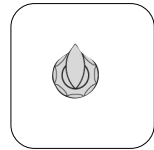

**ZONE 2B**  
Lower-  
body jets.\*



\*Neck jets  
operate in  
all zones.

**5** Use the Bather's control panel to set the temperature, select the filtration, and turn on the jets and lights.

**10** This valve controls the water flow of the neck jets.

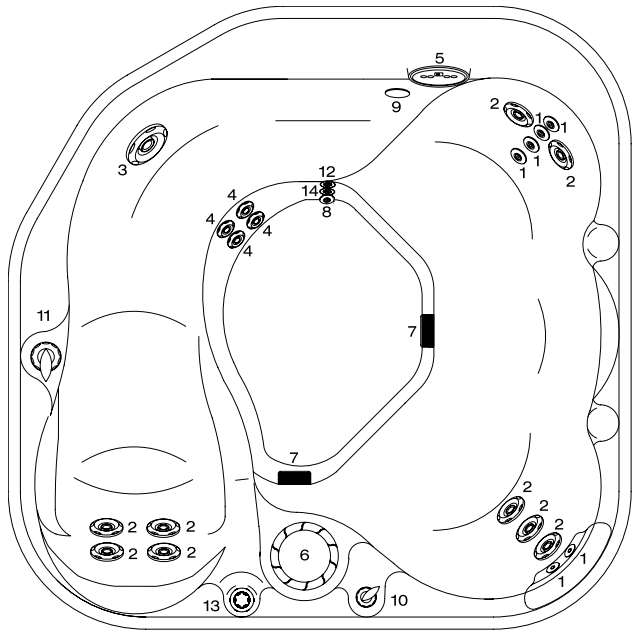

#	Component Identification	Qty.
1	HK™8 Jets	6
2	HK™12 Jets	9
3	HK™16 Jets	1
4	HK™40 Jets	4
5	Bather's Control Panel	1
6	Filter Canisters	1
7	Suction Fittings	2
8	Floor Drain	1
9	Light	1
10	Neck Jet Valve	1
11	Jet Selector	1
12	Ozone-ready Injector Fitting	1
13	Spa Frog® Sanitation (optional)	1
14	Spa Frog® Return Fitting (option)	1
Physical Specifications		Size
Dimensions		77" x 77"
Height		34"
Interior Depth		32.5"
Seating Capacity/Positions		5
Weight Dry/Lbs.		450
Weight Full/Lbs.		2660
Water Capacity/Gallons		265
Total Therapy Jets		20

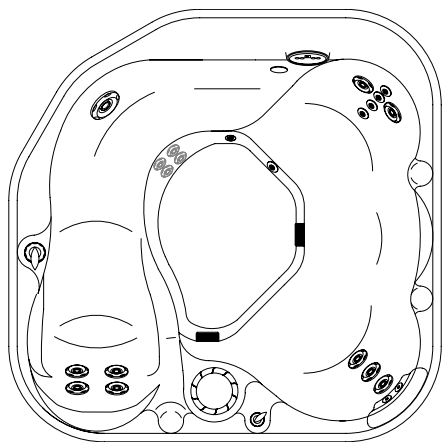

**ZONE 1A**  
Upper- and  
mid- and  
lower-back  
jets.\*

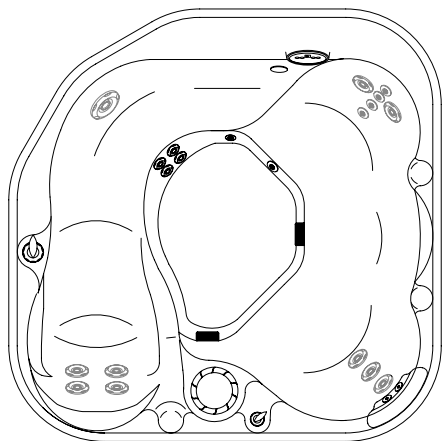
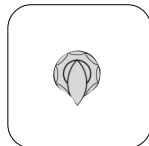

**ZONE 1B**  
Lower-  
body jets.\*

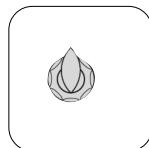

\*Neck jets  
operate in  
all zones.

5 Use the Bather's control panel to set the temperature, select the filtration, and turn on the jets and lights.

10 This valve controls the water flow of the neck jets.

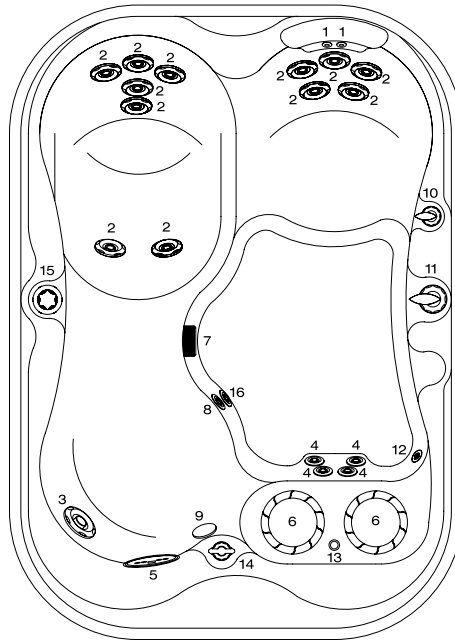

#	Component Identification	Qty.
1	HK™8 Jets	2
2	HK™12 Jets	12
3	HK™16 Jets	1
4	HK™40 Jets	4
5	Bather's Control Panel	1
6	Filter Canisters	2
7	Suction Fitting	1
8	Ozone-ready Injector Fitting	1
9	Light	1
10	Neck Jet Valve	1
11	Jet Selector	1
12	Floor Drain	1
13	Waterfall Feature (option)	1
14	Waterfall Valve (option)	1
15	Spa Frog® Sanitation (option)	1
16	Spa Frog® Return Fitting (option)	1
Physical Specifications		Size
Dimensions		84" x 60"
Height		29.5"
Interior Depth		28"
Seating Capacity/Positions		3/4
Weight Dry/Lbs.		410
Weight Full/Lbs.		1786
Water Capacity/Gallons		165
Total Therapy Jets		19

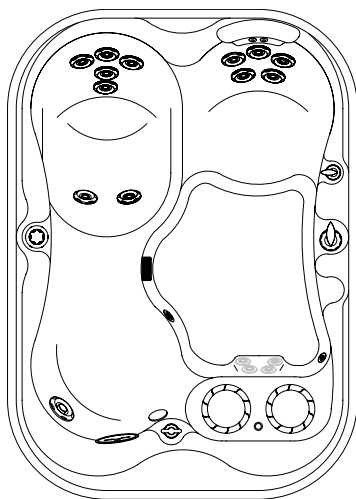

**ZONE 1A**  
Upper- and  
mid- and  
lower-back  
jets.\*

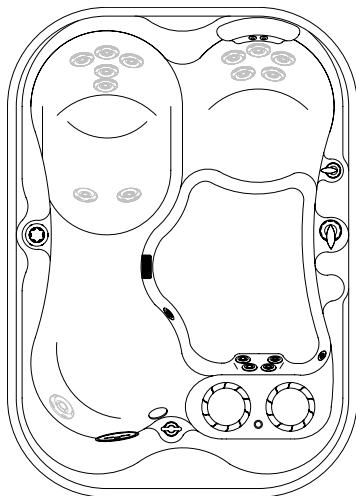
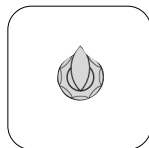

**ZONE 1B**  
Lower-  
body jets.\*

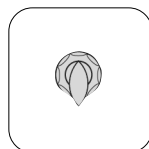

\*Neck jets  
operate in  
all zones.

## ALL MODELS



### PUMP PRIMING (Pr)

Pump priming feature begins at start-up. When your spa is energized, the LCD window displays a “Pr” message. This mode lasts approximately four to five minutes, if not exited manually by pressing the TEMP pad.



### UNDERWATER AND ENTRYWAY LIGHTS

Press the LIGHT pad to turn the underwater and entryway (option) lights on and off. The low-voltage system produces a night light for evening use and makes entering and exiting the spa safer. After being on for 60 minutes, the lights automatically turn off.

### WATERFALL FEATURE (U630, U530, U418, U315, 744E, 641R, 319S)

The Waterfall feature and Convenience Center attaches securely to the dual Vortex skimmer tops. The water flow is controlled by an independent valve. **NOTE:** Don't remove the waterfall top while the pumps are running.



### JETS

Use the JETS pad on the bather panel or remote control. First press of the JETS pad activates pump on low-speed (and starts soak timer). Second press of the JETS pad activates pump on high-speed. Third press of the JETS pad turns jets off for all-quiet mode. Fourth press of the JETS pad turns pump back to low-speed. If the pump is already on low (heating, filter cycle) then the first press starts the soak timer. After running on low- or high-speed for 15 minutes, the pump automatically turns off (unless in heating or filtering cycle).



### SOAK TIMER

The soak timer starts the first time you press a JETS pad. The LCD window displays the elapsed time (1-30) for 55 seconds then switches to the current water temperature for five seconds then back to the timer. It continues to alternate for the entire 30 minutes. The timer runs for 30 minutes





regardless of other functions in use (jets, temperature, or light). You can manually cancel the timer by pressing the TEMP+- pad and then the LIGHT pad.

**CONSTANTCLEAN™ WATER MANAGEMENT**  
with built-in sanitation (see page 61).

### SOLID-STATE OZONATOR

The ozonator greatly reduces the amount of chemical sanitizer you need in the water to keep your water clean. The ozonator functions whenever the system is operating on filter or clean up cycles. You should occasionally inspect your ozonator to ensure it continues to light (see MAINTENANCE, Every Three to Four Months). A good time to do this is when you drain and fill your spa.

### SMARTCLEAN™ FILTRATION

Your spa is preset at the factory with a default setting to filter itself using the jet pump on low-speed for two hours twice in a 24-hour period. These settings represent the filter settings necessary for average use. The timing of the first filter cycle is determined by when the spa was initially energized. The first cycle begins six minutes after this initial power-up. The second filter cycle begins 12 hours after the first cycle.

#### Factory Default Settings:

- Filter Cycle Duration: F2 (2 hours)
- Filter Cycles: 2C (twice per day)
- SmartClean: 1H (1 hour)

These settings represent the most commonly used settings, but your use may be different, depending upon many variables – frequency, number of bathers, duration, water capacity, etc. These variables affect the quality of water and the way it should be managed to achieve the most effective cleansing. Selectable choices for the settings of the operation systems allow flexibility and ensure your Everyday Hot Tub remains easy to maintain for your particular set of circumstances.

### To adjust the filter settings

First press of the SETTINGS pad displays the filter time settings (F1, F2, F4, F6). Use the TEMP+- pad to scroll through the options. When desired selection has been reached, press SETTINGS pad again to enter selection and advance to the filter cycle settings (2C, 1d, 1n). For example, if you select 2C and F2, your spa will filter two hours twice a day for a total of four hours of filtration daily.



Marquis Ozonator reduces the need for chemical sanitizers.





Use the TEMP+- pad to scroll through filter cycle options. When desired selection has been reached, press the SETTINGS pad to enter selection and advance to the SmartClean™ settings.

### Selectable filter cycles and cycle duration

- 2C: twice per day (once every 12 hours)
- 1d: once during the day
- 1n: once during the night
- F1: 45 minutes
- F2: 2 hours
- F4: 4 hours
- F6: 6 hours

### SMARTCLEAN™

Since a spa is always covered when not in use, it stays fairly free of debris or outside contamination. Contamination to a spa's water occurs during usage, so filtering immediately after usage is the most effective time to clean the spa water. Your spa is preset at the factory with a default setting to filter for one hour (1H) every time your spa is used. This filtration cycle begins 30 minutes after the spa light or jet pump has been deactivated. The pump runs on low-speed to filter the water for the cycle's duration.

### Selectable SmartClean Settings

- 1H: 1 hour
- 2H: 2 hours
- 3H: 3 hours
- 4H: 4 hours
- OH: Off



### To adjust the SmartClean settings:

Use the TEMP+- pad to scroll through options. When desired selection has been reached. Press SETTINGS pad to enter selection and exit settings mode.

### TEMPERATURE DISPLAY AND ADJUSTMENT

#### Factory Default Settings:

- Temperature: 102°F (39°C)

The LCD window displays the actual water temperature. Pressing the TEMP+- pad makes the numbers flash, then pressing the pad again (repeatedly) increases the set temperature one degree at a time, up to 104°F (40°C). After a short



pause, the actual temperature displays. Press TEMP+- pad repeatedly to decrease the set temperature to 80°F (27°C).

**\*NOTE:** In event of a power outage, all settings revert to the preset, default settings.

### HEAT MODE

Your spa comes preset in the standard heat mode. For most applications, the standard mode should be used. If you are in a warm weather climate and the spa does not require as much heat, the economy mode may work best. For a vacation home or for very infrequent use, the sleep mode provides filtration and circulation with lower energy demand. In economy mode your spa heats only during the filter cycle. In sleep mode your spa will maintain a water temperature that is 20°F (7°C) below the set temperature. This ensures your spa will be ready to use more quickly (allow about one hour per one degree F for heating your spa's water) when increasing the temperature to the desired level.

The spa's heat mode can be adjusted to one of three different settings:

#### Standard Mode

The spa water heats to the temperature as set at the bather's panel. In this mode the filtration pump turns on for two minutes every half-hour to "poll" or check the water. If heat is needed the unit heats to the set temperature. The LCD window steadily displays the actual temperature in this mode.

#### Economy Mode

In this mode the spa only heats to the set temperature during a filter cycle. The LCD window displays "Ec" alternately flashing with the actual temperature when the spa is up to temperature and "Ec" steadily when the spa's water temperature is below the set temperature.

#### Sleep Mode

Your spa will maintain a water temperature that is 20°F (7°C) below the set temperature. Heater functions only during a filter cycle. The LCD window displays "SL" flashing alternately with the actual temperature when the spa is up to set temperature and displays "SL" steadily when below set temperature.



### To Adjust the Heat Mode:

First press the SETTINGS pad to display the heat mode settings (St, Ec, SL). Use the TEMP+/- pad to scroll through the options. When desired selection has been reached, press SETTING pad again to enter selection and advance to the filter cycle settings (F1, F2, F4, F6).

### HEAT LIGHT

The HEAT light illuminates when the heater is on. The pump circulates on low-speed whenever the thermostat calls for heat.

### SYSTEM LOCK

Once you find and establish the settings that work best for your individual needs, use system lock to keep from inadvertently changing the settings.



Press the TEMP+/- pad and then immediately press the SETTINGS pad. Unlock by repeating sequence. While the system is locked, you may still operate the jets and light. The LCD window displays LC to indicate the system is locked when you try to change the temperature or settings.

### REMOTE CONTROLS

#### Wireless Remote (optional)

##### Underwater light

Press the LIGHT pad to turn the underwater light on and off. The low-voltage system produces a night light for evening use and makes entering and exiting the spa safer. After being on for 60 minutes, the light automatically turns off. For best results point the remote at the IR sensor in the spa.

##### Jets

First press of the JETS pad activates pump on low-speed (and starts soak timer). Second press of the JETS pad activates pump(s) on high-speed. Third press of the JETS pad turns jets off for all-quiet mode. Fourth press of the JETS pad turns pump back to low-speed. If the pump is already on low (heating, filter cycle) then the first press starts the soak timer. After running on low- or high-speed for 15 minutes, the pump automatically turns off (unless in heating or filtering cycle).

**NOTE:** During times of inactivity wireless remotes should always be stored in the cup holder on the lip of the spa. By storing the floating remote out of water it will be less susceptible to water intrusion, a



situation that can occur after extended water exposure. More often water intrusion occurs when spa owners attempt to replace the batteries in their remote and then do not properly reseal it. Battery replacement should only be attempted by spa care professionals.

### Dolphin Remote (optional)

#### Spa functions

Use the pads to control light and jets. See OPERATING YOUR SPA.

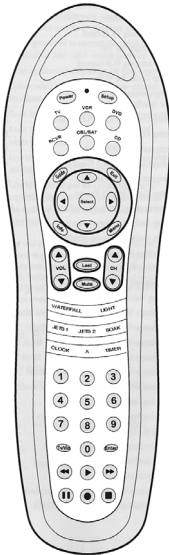

#### Dolphin Remote Soundsations™ operation

It is designed with sophisticated technology that will allow you to consolidate many of your existing remote controls along with the Soundsations audio-ready system in your spa. It's packed with easy-to-use features such as:

- Preprogrammed to operate the cable converter supplied by your cable system provider.
- Preprogrammed technology for easy setup.
- Color-coded keys to quickly locate popular functions
- Code library for video and audio components
- Code Search to help program control of older components
- Learning function to allow programming with another infrared (IR) remote
- Combination IR and RF (radio frequency) capability that can send commands through the optional RF base station to devices in your house.

Before you can use your Dolphin remote, you will need to program it to operate the specific home entertainment components you wish to control. Follow the instructions detailed in Dolphin Remote manual to set up your remote and enjoy our new remote control.



### SOUNDSATIONS™ AUDIO-READY SYSTEM

#### Spa location and speaker cord routing

The factory-installed speaker cord located inside the spa's equipment compartment is 100 ft. long. You must locate the spa close enough to the audio source to allow the cord to be run so it is not exposed to damage and does not create a trip hazard.

**NOTE:** A 200 ft. long speaker cord is available as an optional replacement for the supplied 100 ft. cord. Ask your authorized dealer for details.

Do not replace the supplied speaker cord with any other type of cord.

**WARNING!** Risk of electric shock: Audio source must be placed in a protected location at least five feet from the spa. Do not use a portable stereo. Do not use home audio equipment outside.

Decide on the best path for the speaker cord and then route the speaker cord out of the equipment compartment in the most appropriate manner for the installation.

The speaker cord must be installed by a licensed electrician in accordance with the National Electric Code and all local building codes. Additional installation advice from an A/V technician may be helpful or necessary if there are any special circumstances, such as connecting to unique or complicated home theater systems.

#### Connections

**CAUTION!** Risk of electric shock: The stereo cord-connection within the equipment compartment and the supplied 100 ft. cord which is used to conduct the audio signal to the spa are intended to carry a low voltage (12V) audio signal supplied by a conventional household-type audio system. The cord-connection and cord are not to be used for any other purpose.

**CAUTION!** Before making any connections, turn off the stereo receiver and unplug it from the power source. Failure to do so may result in damage to the system.

1. To prepare the end of the speaker cord, strip approximately 2" off the outer jacket.
2. To prepare the ends of the wires, strip approximately 1/2" of insulation from each wire. Then, twist the bare ends of each wire so there are no loose strands of wire.

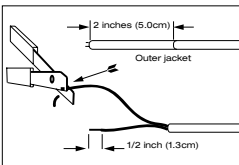

Strip approximately 2" off the outer jacket of the speaker cord.

**WARNING!** Never use broken or frayed wire, as damage or electrical shock may result.

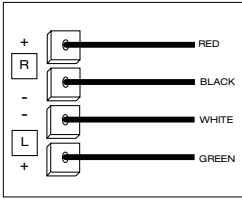

Wire connections.

**CAUTION!** Exposing too much wire or having wires with frayed ends could cause wires to touch each other, which could damage the equipment.

3. Wire connections
  - A. Red = Right (+)
  - B. Black = Right (-)
  - C. White = Left (-)
  - D. Green = Left (+)

**NOTE:** Do not connect speaker cord to any speaker terminals already in use.

4. Check all connections to the stereo receiver. Make sure all wires are connected in phase (+ to + and - to -). Correct any wiring problems before reconnecting the stereo receiver to the power source.

You should perform a routine inspection (every three months) of the Soundsations Audio System to ensure that the system is operating properly.

If the cord or cord-connection is damaged; if the door to the equipment compartment shows signs of deterioration; if excessive water is entering the equipment compartment; or if there are other signs of damage to related components, turn off the spa and have the damaged component repaired by a qualified service person.

### Recommended components

Use stereo receivers rated from 60 to 120 peak watts per channel and rated from 8 to 16 ohms.

The Soundsations Audio System has automatic protection circuits to protect against overload. This circuit activates at high volume levels to reduce output, causing a decrease in volume. This is normal operation and indicates that the power input may be exceeding safe levels. If this protection circuit has been activated, turn down the volume to allow the system to reset itself and resume normal operation. Sustained listening at high volume settings is not recommended.

**CAUTION!** Please read this installation guide completely before the installation. Failure to follow the instructions in this guide voids all warranties on the Soundsations Audio System.

## equipment diagram

MODELS 630, U630, 530, U530, 744E, 641R

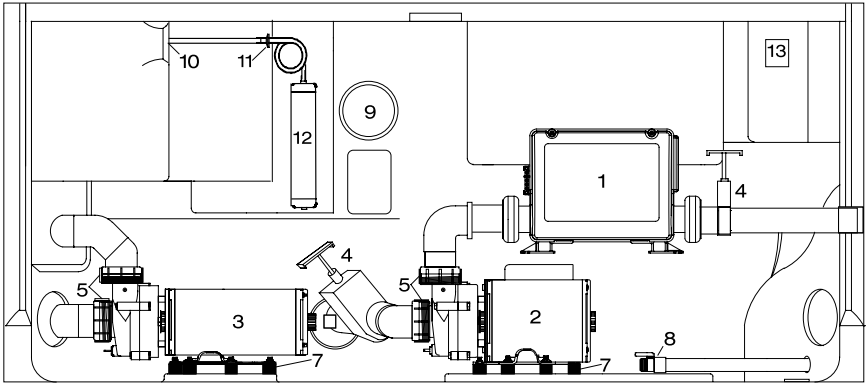

#	Component	Qty.
1	Control box and heater	1
2	MP160 pump	1
3	HP130 pump	1
4	Slice valves	2
5	Pump unions	4
7	Motor mounts	8
8	Hose bib drain	1
9	Light bulb	1
10	Ozone fitting	1
11	Check valve	1
12	Ozonator (option 744E, 641R)	1
13	Soundsations™ plug (option)	1



## equipment diagram

MODELS 418, U418, 315, U315, Rendezvous, Retreat, 520M, 319S

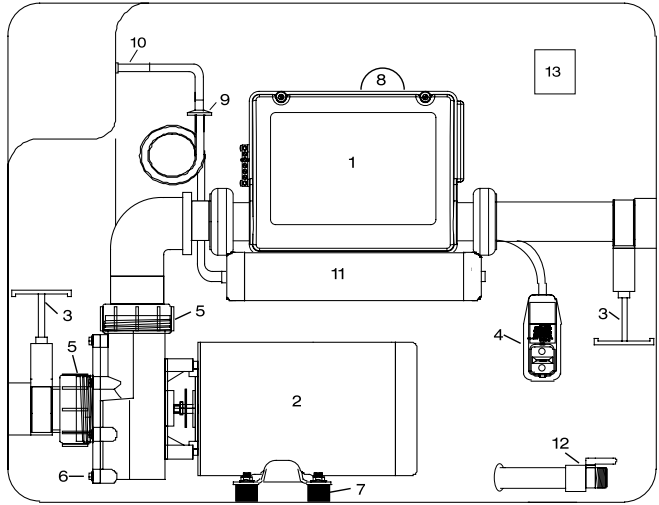

#	Component	Qty.
1	Control box and heater	1
2	HP120 pump (315, U315, Rendezvous, Retreat) or MP160 pump (315, 418, U418, 319S, 520M upgrade)	1
3	Slice valves	2
4	GFCI (315, U315, Rendezvous, Retreat, 319M, 520M)	1
5	Pump unions	2
6	Pump plug	1
7	Motor mounts	4
8	Light bulb	1
9	Check valve	1
10	Ozonator fitting	1
11	Ozonator (option 520M, 319S)	1
12	Hose bib drain	1
13	Soundsations™ plug (option)	1

**PLEASE NOTE:** The following corrective actions may be performed by the spa owner. If the trouble cannot be corrected in the steps below, please contact your Marquis Spas® dealer for service. (Improper servicing by an unauthorized service provider or spa owner could result in damage not covered by the warranty and could cause serious injury.)

### **EQUIPMENT WILL NOT OPERATE**

- Check the control panel LCD window for diagnostic code.
- 240V Spas: Check the circuit breaker on the main circuit panel.
- 120V Spas: Check the GFCI power cord and reset if necessary (see IMPORTANT SAFETY INSTRUCTIONS at beginning of manual).
- Check the condition of the power cord.

### **INADEQUATE JET ACTION**

- Be sure the shut-off valves are completely open.
- Open the jets by turning the jet face to allow for maximum water flow.
- Check for obstruction or restrictions at suction guard(s) or filters, such as leaves, etc.
- Check to ensure water is at proper level and add water if needed.

### **NO HEAT**

- Check temperature displayed in the LCD window for desired temperature setting.
- Inspect the filter cartridge for dirt and debris.
- Check that the water is at proper level, 2/3 up the Vortex skimmer opening.
- Check HEAT MODE to be certain spa is not in SLEEP MODE.
- Lower ambient temperatures may result in heat loss.

**NOTE:** Do not expect instant hot water from the jets. It will take the heater 12-24 hours to heat the water to the temperature you desire.

### **LIGHT DOES NOT WORK**

- Press the LIGHT pad on the control panel.
- Reposition the light bulb in the socket. (See REPLACING LIGHT BULB.)
- Replace the light bulb with a **6 WATT BULB (GE 918 ONLY)**.

### LCD DIAGNOSTIC MESSAGES

The advanced technology built into the spa allows it to perform a number of self-diagnostic system checks and it can display a variety of messages in the LCD window on the control panel.

**HH:** Overheat. The spa has shut down. **DO NOT ENTER THE WATER.** Contact your dealer for service.

**OH:** Overheat protection. If a malfunction occurs and the spa water reaches 110°F (43°C), the system completely shuts down. In such a condition, **DO NOT ENTER THE WATER.** Turn off all power to the spa and contact your dealer for service. Several conditions could lead to overheating, for example, low water level, shut-off valves closed while heater is on, dirty filter, and restriction in the plumbing lines. After the power is turned back on, the spa will not restart itself until the water temperature within the spa drops to a lower, predetermined temperature. As a double safety feature, a secondary high-limit sensor shuts the system off if the water temperature in the heater housing reaches 118°F (48°C). In this case, the spa may be restarted by pressing any panel pad after the water has cooled to 110°F (42°C). If the switch trips repeatedly, do not use the spa and contact your dealer for service.

**IC:** Ice. Potential freeze condition detected.

**SA:** Spa is shut down. Sensor plugged into sensor "A" jack is not working.

**Sb:** Spa is shut down. Sensor plugged into sensor "B" jack is not working.

**Sn:** A sensor has malfunctioned. If alternating with spa temperature, it may just be a temporary condition. If flashing by itself, spa is shut down. Contact your dealer for service.

**HL:** A significant difference between temperature sensors has been detected. This could indicate a flow problem. Check water level in spa and refill if necessary. If water level is okay, make sure the pumps have been primed.

**LF:** Persistent low flow problems. Heater is shut down, but other spa functions continue to run normally. Check water level and refill if necessary. Contact your dealer for service.

**dr:** Possible inadequate water, poor flow, or air bubbles detected in the heater. Spa is shut down for 15 minutes. Check water level and refill if necessary. If okay, check that pumps have been primed. Press any button to reset.

**dY:** Inadequate water detected in heater. Spa is shut down. follow directions for "dr" message.

## WEEKLY MAINTENANCE

### 1. Removing Debris

Remove any debris from the Vortex skimmer and suction guard(s) on the inside of the spa. Blocked intakes can impede the flow of water through the jetting system.



Water level should be two-thirds up the Vortex skimmer opening.

### 2. Water Level

Replenish the water level if necessary so that it is approximately two-thirds up the Vortex skimmer opening. (See STARTING YOUR SPA.)

## MONTHLY MAINTENANCE

### 1. Filter Care

We cannot stress enough the importance of a clean filter for proper water filtration. Dirty filters can restrict water flow, cause hazy water, and prevent your chemicals from working properly. Many water treatment products clear or clarify the water by clumping microscopic particles and minerals together so that these larger particles can be effectively trapped in the filter. A filter clogged with debris and calcium deposits does not trap particles properly.

The Maintenance Reminder on the control panel indicates a CL every 30 days to remind you to clean your filter.

### Removing the Filter

Grasp the edge of the dome-shaped Vortex filter top, pull up firmly, but gently, to remove it.



Grasp edge of Vortex filter top, pull gently.

Turn the filter cartridge counterclockwise to unscrew it from its base. Lift out the filter cartridge.

Use a hose to clean the filter cartridge or use a bucket and *Filter Cleaner* to soak the filters (you will need to flip the filter after the designated time to completely clean the entire length).



Turn filter cartridge counterclockwise to unscrew.

**NOTE:** Keep an extra set of filters on hand so you always have a clean set ready for immediate spa enjoyment. Remember to replace the filter cartridge at least once a year. Replacement filters are available from your authorized dealer.

## Reinstalling the Filter

Repeat the steps above in reverse. Do not overtighten the filter as it may cause the threads on the bottom to strip and fail to hold the filter in place. When replacing the Vortex filter top, center the top over the raised filter ring and press down firmly until the top snaps into place. (See INSTALLATION INSTRUCTIONS, Filter Cartridge.)

## EVERY THREE TO FOUR MONTHS

### Draining and Filling the Spa

The average spa needs to be drained every three to four months. After months of continually adding chemicals to the water and introducing body oils and lotions, the water can be difficult to manage and chemicals are not as effective as usual. You may also notice excessive foaming. A maintenance reminder appears on the control panel as “CH” to remind you to change water. More frequent draining may be required depending on use.

#### 1. Leakage Detection

Open the equipment door and check for signs of water leakage around the pump. Pump seals wear out over time, especially with improper water chemistry. Early detection of pump seal failure can significantly reduce repair costs.

#### 2. Ozonator Operation

Check to see if the bulb is lighted. The ozonator functions whenever the system is running on filter or clean up cycles. The end cap of the ozonator should glow if functioning properly. If not, the bulb has burned out. Contact your dealer for service.

#### 3. Draining the Spa

- A. Turn off the power to the spa.
- B. Remove the hose bib plug from the external drain and fill connection and attach a hose.
- C. Open the drain valve in the equipment compartment.
- D. When the spa is empty, close the drain valve and remove the hose. Reinstall hose bib plug.

**NOTE:** Keep the drain valve closed at all times except when draining the spa (do not rely on the cap to stop the flow of water). Not doing so could result in damage to the drain valve due to freezing water.

### Replacing Mineral Cartridge

The *Spa Frog® mineral cartridge* should be replaced every four months. You may still feel the “spent” minerals inside, but they are no longer effective and need to be replaced.



Check the end cap of the optional ozonator for a purple glow.



## AS NEEDED MAINTENANCE

### 1. Cover Care

It is recommended that you use *Cover Cleaner* to keep the spa cover clean and conditioned. Proper care of the cover increases the life and keeps it looking great in even the harshest conditions. **NOTE:** Do not use regular household products or products that contain silicone, alcohol, steel wool, or bleach.

### 2. DuraWood Exterior

Clean the exterior of the spa with a mild soap and water solution. Cleaners containing alcohol, Acetone, Nitrobenzene, and Cyclohexanol can dissolve and discolor the DuraWood exterior.

### 3. Wood Exterior

The wood exterior has been treated with a water-based wood preservative at the factory. We suggest the exterior be treated every six months with an additional coat of preservative for maximum weather protection. Your dealer can suggest the best preservative for your environment.

### 4. Clean the DuraShell® Interior

Once the spa is drained, clean the DuraShell interior – especially at the water line. We suggest the *Glove Sponge* to clean without scratching.

Clorox bleach (diluted) is the only approved cleaning agent for DuraShell – any other products should be avoided.

**NOTE:** Due to the high-gloss, fine finish of the acrylics, imperfections in the surface texture may occur. These in no way compromise the integrity of the spa shell.

**NOTE: Do not leave an empty spa uncovered. Direct sunlight on the spa surface can cause severe damage or blemishing and can result in the voiding of any surface warranties.**

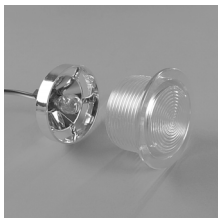

Remove lamp socket from back of light assembly.

### 5. Excess Debris

Grit and debris tracked into the spa should be removed with a spa vacuum.

### 6. Water Line

To avoid buildup of oils and lotions at the water line, clean the interior when needed. We suggest the *Glove Sponge* to clean without scratching.

**NOTE:** Do not use the same brush or sponge to clean the exterior of the spa and the interior of the spa. Soap and other product residue used on the outside of the spa can cause foaming of the spa water and scratches to the spa surface.

### 6. Light Bulb Replacement

- A. Turn off the power to the spa.
- B. Remove the equipment area door to find the light access. (See EQUIPMENT DIAGRAM.)
- C. Remove the lamp socket from the back of the light assembly by turning counterclockwise and pulling at the same time.
- D. Gently pull the bulb out of the lamp socket and replace it with a **6 watt bulb only (GE #918)** available from your spa dealer.
- E. Install the lamp socket back into the light assembly and replace door.

### SUSPENDED USE OR WINTERIZING THE SPA

Your spa was designed for year-round use and many people find the combination of hot water, therapy jets, and cool winter temperatures to be especially soothing. However, if you decide to discontinue the use of your spa for any extended period of time, we suggest you follow the steps below.

**NOTE:** During long periods of inactivity, damage can occur to equipment from condensation within the equipment compartment.

1. Turn off the power to the spa.
2. Drain the spa. (See DRAINING AND REFILLING THE SPA.)
3. Remove all residual water from the seating and footwell. If necessary, bail out the remaining water then dry the spa with towels. A wet/dry vacuum is recommended for best results.
4. Using the wet/dry vacuum, place vacuum nozzle over each jet nozzle to remove water from plumbing lines, starting with the highest jet and finishing with the lowest jet.
5. Unscrew the pump plug from the pump. (See STARTING YOUR SPA.)
6. Again, using the wet/dry vacuum, place nozzle over the exposed pump opening to remove excess water. The pump should be removed from the spa and stored in a climate-controlled room.
7. Clean the spa interior.
8. Clean the filter cartridge.
9. Reinstall the spa cover and lock in place.

**NOTE:** Direct sunlight on the spa surface can cause severe damage or blemishing and can result in the voiding of any surface warranties.

**IMPORTANT CHEMICAL SAFETY PROCEDURES**

1. Always keep chemicals out of reach of children.
2. Read product labels carefully prior to use.
3. When dissolving, always add chemicals to water, do not add water to chemicals. Some dry chemicals should be dissolved prior to adding them to the spa. Using a clean container, dip some water from the spa. Mix until dissolved, then add to circulating water.
4. **CAUTION:** Do not mix chemicals together. Add them separately to the spa water.
5. All chemical products should be stored in a cool, dry, well-ventilated area where the average temperature does not exceed 90°F (32°C). Keep storage area clean of debris such as rags, newspaper, and combustible materials.
6. Keep chemicals away from open flame or other heat source. Do not smoke near chemicals. If a dry chlorine chemical fire should occur, use water only. Do not use a dry chemical fire extinguisher to attempt to put out the fire.
7. When adding chemicals, always keep the water circulating in the spa with jets in a downward circular pattern for better chemical distribution. Add chemicals to the spa water one at a time. Allow several minutes between any new chemical additions using the jet action to evenly distribute throughout the spa.
8. After adding chemicals, wait the amount of time recommended on the chemical container before retesting your water for an accurate reading. Retest your spa water before using.
9. If you have any questions or concerns about the correct procedures for handling chemicals, please contact your spa dealer or Marquis Corp.



### WATER CARE

There are three things necessary for clean safe water:

1. **CIRCULATE:** Water has to be circulated regularly; it can not be stagnant.
2. **FILTER:** Water has to be filtered to remove particulate and debris.
3. **SANITIZE:** Water has to be sanitized to kill organisms like algae, bacteria and virus.

The control system in your spa will automatically circulate and filter. (See SPA CONTROL OPERATION, ConstantClean™ and SmartClean™ sections.) The sanitation requires minimal effort if done consistently and properly.

To sanitize spa water, three things are required:

1. **BALANCE:** The water must be balanced so the sanitizer can work and spa equipment is protected.
2. **SHOCK:** Shock to oxidize organics and maximize sanitizer efficiency.
3. **SANITIZE:** Maintain a proper level of sanitizer at all times.

### UNDERSTANDING WATER BALANCE

Water balance is the interrelation of factors that determine the quality of the spa water. The effectiveness of chemicals and other additives are dependent on all these factors working together or “in balance”. The primary elements to water balance are the calcium hardness, total alkalinity and pH.

It's important to understand a spa is not just a “small swimming pool” and the care of a spa should be handled differently. Spa water is kept at a temperature of up to 104°F (40°C) but pool chemicals are designed for cool water. Plus the ratio of people per gallon in a spa is much higher than in a pool – four people in a spa is the equivalent of having 200 people in a typical backyard pool. This increased “bather load” increases the residue from soaps, perfumes, body oils, cosmetics, and other contaminants. Always use water treatment products recommended for use in your spa.

### pH Balance

Keeping the pH balanced is the most critical component of water balance. Calcium hardness

and total alkalinity act as buffers to stabilize the pH. When they are properly adjusted, the pH will be stable and easy to maintain. The pH is a measure of the relative acidity and basicity of the water. The ideal pH range is 7.2 - 7.8. When the pH falls below 7.2 the water can become corrosive. Low pH can cause damage to metal in the control system and heater, excessive sanitizer consumption, and skin irritation. A pH above 7.8 can be scale-forming and allow metals or minerals in the water to form deposits and stain spa surfaces.

### **Alkalinity**

Alkalinity acts as a buffer to prevent the pH from changing as other substances are added to the water. Stability of the pH is directly related to the alkalinity. The alkalinity should be between 80 - 140 ppm. Alkalinity below 80 ppm makes it difficult to stabilize the pH. Alkalinity above 140 ppm may increase the pH and cause cloudy water, scaling, and decreased efficiency of the sanitizer.

**Note:** *Alkalinity & pH Increaser* and *Alkalinity & pH Decreaser* will affect both the pH and alkalinity. Generally, smaller additions will change the pH and have a very minor effect on the alkalinity. Larger additions will also affect the pH, but will have a much greater effect on the alkalinity. (Example: If the pH is very high and the alkalinity is within range, adding a few smaller doses of *pH and alkalinity Decreaser* instead of one large dose will reduce the pH with little effect on the alkalinity.)

### **Calcium Hardness**

Do not use soft water in your spa. It is critical to have calcium in your water and in most cases tap water is fine. The ideal range of calcium is between 200 - 300 ppm. The calcium hardness is normally adjusted when filling or refilling after draining the spa. High calcium levels can cause scale buildup on spa surfaces and equipment. Your spa can be protected against high calcium by using *Metal & Stain Remover* per the directions on the container. Low calcium levels can cause spa water to become highly corrosive and damaging to the equipment components and plumbing. To raise calcium levels, use *Calcium Hardness Increaser*. Most authorized dealers can test the calcium hardness of your water.

### BALANCE

When initially filling or refilling your spa follow these steps to achieve proper water balance.

**IMPORTANT!** Always follow instructions on the chemical container when adding chemicals.

1. Test the spa water using a test strip or test kit. Determine the pH and alkalinity of the water.
2. If adjustments are needed for the pH and/or alkalinity, always balance the alkalinity before balancing the pH. The product(s) you should use to adjust pH and/ or alkalinity are *pH & Alkalinity Up* or *pH & Alkalinity Down*. Make any additions per the directions on the bottle and then test and repeat if necessary until all readings are in the desired range.
3. Increase the calcium hardness if necessary.

### SHOCK

#### Initial Treatment

Shock the spa using granular *Chlorine Sanitizer* or non-chlorine *Spa Shock*. Add directly to the spa per the instructions on the container. For the initial treatment, *Chlorine Sanitizer* is preferred as it will also establish a residual of sanitizer.

#### Maintenance Treatment

Once bacteria and other wastes are neutralized by the sanitizer, they stay in the water unless oxidized or shocked. Often called chloramines or bromamines, they create dull, cloudy water and can cause odor and eye or skin irritation. Shock treatment rids your spa of these wastes for clear, sparkling water. Shocking with non-chlorine *Spa Shock* or granular *Chlorine Sanitizer* is recommended once a week or whenever the water appears dull or cloudy or has a strong odor. Non-chlorine *Spa Shock* allows use of the spa 15 minutes after shock treatment.

**NOTE:** A strong bromine or chlorine odor typically indicates the spa needs to be shocked – not that there is too much bromine or chlorine in the water. A properly balanced spa that is shocked regularly will not have an odor.

## SANITIZE

### ConstantClean™ System

The ConstantClean system utilizes a combination of sanitizers to increase water quality and significantly decrease maintenance. The combination of a *Spa Frog® Mineral Cartridge\** and the factory installed ozonator greatly reduce the amount of sanitizer required. Instead of the normal 3 - 5 ppm of bromine, you now only need to maintain 1 - 2 ppm of bromine.

\* The built-in sanitation system is not available in some international markets. However, the ozone system is standard on all spa models in all countries. Please see your dealer for recommended alternate treatment method if Spa Frog® is not available.

Setting Window >



**BUILT-IN SANITATION SYSTEM\***

After shocking the spa water with *Chlorine Sanitizer* granuals or non-chlorine *Spa Shock*, bring the spa water to operating temperature. Then install the Spa Frog® cartridges.

**ADJUST THE MINERAL CARTRIDGE\***

Remove the protective cellophane wrap from the *Spa Frog® mineral cartridge*. While holding the bottom of the cartridge, turn the top until the number six appears in the setting window.

**NOTE:** This cartridge should be replaced every three to four months. You will still feel the “spent” minerals inside, but they are no longer effective and the cartridge needs to be replaced. It is recommended to drain and refill the spa at the same time you replace the mineral cartridge.

**ADJUST THE BROMINE CARTRIDGE\***

Remove the protective cellophane wrap from the *Spa Frog® bromine cartridge*. Finding the right setting for the bromine cartridge will require monitoring your usage for the first few weeks. Begin with an initial setting based on the chart below and monitor bromine levels daily for the first week or so, adjusting the cartridge by one setting per day until a 1 - 2 ppm level has been achieved. To adjust cartridge, remove from system and turn to the next highest setting if the bromine level is low, or the next lower setting if the bromine level is high. The bromine cartridge needs to be replaced when empty between two and four weeks. Always maintain 1 - 2 ppm of bromine.



**Suggested *Initial* Bromine Cartridge Settings**

Filter cycle duration	Spa Gallons		
	150-250	250-300	300-400
One hour	1	2	3
Two hours	1	2	2
Four hours	1	1	2

Install cartridges in the holder.



Cartridge holder cap

### INSTALL THE CARTRIDGES

Locate and remove the cartridge holder cap on the top lip of the spa. Push down and turn the holder counterclockwise to unlock. Lift holder out. Snap the *Spa Frog® mineral cartridge* into the area of the holder marked “MINERALS” (top portion), making sure to line up the indentation near the top of the cartridge with the raised line on the holder. Then snap the *Spa Frog® bromine cartridge* into the area of the holder marked “BROMINE”. Be sure to line up the indentation on the cartridge with the raised line on the holder. After cartridges are snapped in, return the holder, push down, and then turn clockwise to lock into place. Replace the cap.

**CAUTION:** Hand tighten only; avoid over tightening; avoid bending the holder to help prevent damage to the holder.

### REMOVE THE CARTRIDGES

Reverse above procedures to remove cartridges.

\*The built-in sanitation system is not available in some international markets. See your dealer for recommended alternate water treatment method.

### WATER CARE REGIMEN

SpaCare™ products are classified by easy to follow usage guidelines. The information below indicates whether the product should be used daily, weekly, monthly, when filling, or as needed – if special water conditions arise.

#### DAILY

##### Sanitizer

Maintain 1 - 2 ppm of bromine at all times.

#### WEEKLY

##### Shock Treatment

Sanitizer combines with bacteria and neutralizes it on contact. However, the used sanitizer/bacteria particle is still present in the spa water. Used sanitizer in the water emits an odor and causes cloudy water. To oxidize, or rid the spa of this used sanitizer, you must shock the spa once a week.

#### AS NEEDED PRODUCTS

##### pH & Alkalinity Up

##### pH & Alkalinity Down

These two products work to raise or lower the pH and alkalinity in the spa. They are only needed if the test strip indicates the levels are not in the ideal ranges.

##### Water Clarifier

Microscopic particles can pass through the spa filter and create cloudy water. *Water Clarifier* combines these microscopic particles into larger particles that can be trapped in the filter to clear cloudy water.

##### Spa Defoamer

If foam appears in your spa, the action of the jets will keep it from dissipating. The use of Spa Defoamer instantly rids your spa water of foam.

##### Metal and Stain Remover

*Metal and Stain Remover* will remove metals such as iron and copper from spa water. Used on a weekly basis, it will protect the spa from possible scaling caused by high levels of calcium.

## TROUBLESHOOTING GUIDE

**P:** Problem

**S:** Solution

### Cloudy Water

**P:** Inadequate filtration or dirty filter.

**S:** Ensure that the filter is securely installed. Clean or replace filter. Increase the length of clean up and/or filter cycles.

**P:** Water is not balanced.

**S:** Test water and adjust pH, alkalinity, and sanitizer as needed. Shock to oxidize and destroy organics in the water.

**P:** Unfiltered particles or chemically saturated.

**S:** Use *Water Clarifier* to combine particles.

**P:** High total dissolved solids

**S:** Drain, clean, and refill the spa.

### Chemical Odor

**P:** Too many chloramines/bromamines in the water.

**S:** Treat water with *Spa Shock* then adjust sanitizer level as necessary.

**P:** Dull looking water, difficult to manage. High total dissolved solids (TDS) may be the cause.

**S:** Drain and refill with fresh water.

### Musty Odor

**P:** Not enough sanitizer in water – bacteria or algae in water.

**S:** Add sanitizer as necessary and shock. Re-adjust sanitizer level if necessary.

### Yellow Water

**P:** Low pH and/or low alkalinity.

**S:** Test and adjust pH with *pH and Alkalinity Up*. Adjust alkalinity if necessary.

### Foaming

**P:** High concentration of body oils, lotions or soaps, as well as excessive organics.

**S:** Use *Spa Defoamer* and adjust pH and sanitizer as needed.

### Scum Line in Spa

**P:** Body oils and dirt.

**S:** Use *Glove Sponge* to clean the spa. Test and adjust the sanitizer and pH if necessary. Increase the clean up cycle.



### No Sanitizer Reading

- P:** Sanitizer level is too low.
- S:** Shock and/or adjust Spa Frog® bromine cartridge until the sanitizer registers in the recommended range.
  
- P:** Test strip remains “white” even after sanitizer has been added.
- S:** Sanitizer level could be extremely high. It can bleach the reagents on the test strip and give a false reading.  
Remove spa cover and activate jets and air control. Allow jets to run for 30 minutes. Test water to see if desired level has been reached. Adjust *Spa Frog® bromine cartridge* to reduce bromine level.

### High Sanitizer Reading

- P:** Too much chlorine or bromine added or dispensed into the spa.
- S:** Remove spa cover and activate jets and air control. Allow jets to run for 30 minutes. Test water to see if desired level has been reached. Adjust *Spa Frog® bromine cartridge* to reduce bromine level.

### Eye or Skin Irritation

- P:** Contaminants or excessive amount of chloramines/bromamines in water.
- S:** Treat water with *Spa Shock*. Adjust sanitizer level.

- P:** pH is low.
- S:** Adjust as needed.

### Corrosion of Metal

- P:** Low pH.
- S:** Adjust pH with *pH and Alkalinity Up*.

### Green Water/Algae

- P:** Low sanitizer level or high pH.
- S:** Adjust pH, shock and/or adjust *Spa Frog® bromine cartridge* as necessary.

### Erratic pH

- P:** Alkalinity and/or calcium hardness are too low causing pH “bounce”.
- S:** Test and adjust alkalinity and/or calcium hardness to bring them into the ideal range.



**SPABOUTIQUE™**

A collection of unique items to delight your senses, free your time, and make your life easier.

**SpaCare™** gives you maintenance products to ease spa care – inside, outside, and especially the water.

**SpaTherapy™** surrounds your senses with aromas, visions, sounds and feel-good products to bring you and your environment to life.

**SpaStyle™** brings convenience items to enhance your lifestyle, while soaking in the spa or relaxing on the deck.

SpaBoutique offers a full range of spa and backyard accessories, including SpaCare™ products, Spa Frog® products, replacement filter cartridges, cover lifters, steps, and more. See your authorized dealer for a complete catalog of items.

### MARQUIS SPAS® LIMITED WARRANTY

#### [5] SPA SHELL, SPA SHELL LEAKS, AND STRUCTURE

Marquis Spas warrants the spa shell against peeling, cracking, yellowing, blistering, or delamination for a period of five years\*. Spa shell and structure are warranted against leaks for a period of five years\*.

#### [5] SPA CABINET

Marquis Spas warrants the DuraWood exterior against peeling, cracking, blistering, or delamination for a period of five years\*. Natural cedar exterior is warranted to be free from defects at time of delivery.

#### [5] PLUMBING

Marquis Spas warrants the internal plumbing, internal glue joints, and all bonded parts against leaking for five years\*.

#### [3] MAJOR COMPONENTS AND SYSTEMS

Marquis Spas warrants the jet pump, pump seal, controls, equipment pack, and no-fault heater against any malfunction or defect in materials or workmanship for a period of three years\*.

#### [1] FACTORY-INSTALLED PARTS

Marquis Spas warrants all factory-installed spa parts and components including drain bib, GFCI cord, gaskets, fuses, removable jet fittings\*\*, skimmer lid\*\*, light bulb\*\*, light lens\*\*, spa cover\*\*, cover locks and latches\*\* for a period of one year.\* Filter cartridge and chrome jet covers are excluded from extended warranty, but are warranted to be free from defects at time of sale.

#### TRANSFERABLE

This warranty is transferable to all subsequent spa owners.

\*Warranty coverage begins from date of purchase by the original owner, or begins one year after date of manufacture, whichever begins first, and extends for the specified length of time for each component.

\*\*Customer must return part to Marquis Spas dealer for replacement.

This warranty extends to the original retail purchaser of the spa for personal, family or household purposes only. This warranty is transferable. Warranty coverage begins from date of purchase by the original owner, or begins one year after date of manufacture, whichever begins first, and extends for the specified length of time for each component.

In order to obtain the benefit of this warranty, the spa owner shall notify their authorized Marquis Spas dealer of any problem or warranty claim within thirty days of the time the problem is discovered. In the event the spa owner is unable to obtain parts or service from an authorized Marquis Spas dealer, the spa owner should contact the Customer Service Department of Marquis Spas. Notice of a problem can be sent to Marquis Spas via email at [service@marquiscorp.com](mailto:service@marquiscorp.com) or in writing to Marquis Spas, 596 Hoffman Road, Independence, OR 97351-9601. Direct all correspondence to Customer Service Department.

#### PERFORMANCE OF WARRANTY

Marquis Spas agrees to repair any plumbing or surface defects and to repair or furnish a replacement for any factory-installed components covered under this warranty which, upon test and examination by Marquis Spas, prove defective. All materials for examination must be returned to Marquis Spas freight prepaid.

Marquis Spas unconditionally warrants the no-fault heater against any failure that requires replacement. Unconditional is defined as warranty coverage without exception if the component fails to operate properly within the spa's system, including, but not limited to, water chemistry damage.

Replacement parts, including light bulbs, skimmer lids, removable jet fittings, covers, cover locks and latches must be returned by the customer to the authorized Marquis Spas dealer for replacement.

Your authorized Marquis Spas dealer reserves the right to assess a travel or trip charge for service calls.

**THIS WARRANTY IS LIMITED TO THE REPLACEMENT OR REPAIR OF THE DEFECTIVE ITEMS AS STATED IN THIS SECTION OF THE WARRANTY.**

### **INVALIDATION OF WARRANTY**

This warranty is void if this spa has been subjected to alteration, misuse or abuse, or if any repairs on the spa are performed or attempted by anyone other than an authorized Marquis Spas service center. "Alteration" is defined as any component or plumbing change, electrical conversion, or the addition of any alternative heating or sanitation device(s) other than Marquis Spas recommended components which contribute to component or unit failure. "Misuse and abuse" shall include, without limitation, any installation, maintenance or operation of the spa other than in accordance with Marquis Spas printed instructions (located in the Owner's Manual) or use of the spa in a manner or for a purpose other than for which it was designed. Under no circumstances shall Marquis Spas or any of its representatives be held liable for injury to any person or damage to any property, however arising.

Other items not included in this warranty are freight expense; labor and material costs associated with removal and/or replacement of spa; damage to the spa surface and equipment due to the use of trichlor chlorine, or other harsh chemicals not recommended by Marquis Spas; damage to or fading/staining of the spa surface or equipment caused by impact, scratching, abrasive or corrosive cleaners, or extreme water temperatures (outside the range of 32°F to 120°F, 0°C to 49°C). Damage to the spa surface caused by leaving the spa uncovered and empty of water with direct exposure to sunlight may cause solar heat distress and would invalidate this warranty.

Other costs not associated to the direct repair of the spa, such as phone charges, missed work, and damage caused to the spa beyond Marquis Spas control, are not included in this warranty. Items beyond Marquis Spas control include but are not limited to damage resulting from: improper electrical connections; accidents; failure to follow procedures defined in the Owner's Manual; cleaning agents; and natural occurrences such as lightning.

**IMPORTANT: SOME STATES DO NOT ALLOW THE EXCLUSION OR LIMITATION OF INCIDENTAL OR CONSEQUENTIAL DAMAGES, SO THE ABOVE LIMITATION OR EXCLUSION MAY NOT APPLY TO YOU.**

### **DISCLAIMERS**

There are no additional warranties, express or implied, which extend beyond the terms of this limited warranty.

No other person or entity has been authorized to make any warranty, representation or promise of performance not included in this express written warranty, and Marquis Spas shall not be bound by any such additional warranty, representation or promise.