



# 880 SERIES

ALTAMAR™ | CAPRI™ | CAMEO™ | MAJESTA™ | MARIN™ | MAXXUS™ | OPTIMA™

## OWNER'S MANUAL

6530-395T Rev. A

# Sundance® Spas

# Attention New Hot Tub Owner!

Congratulations on the purchase of your new Sundance® hot tub! The following is a list of automated functions performed by your hot tub. These functions are listed below in an attempt to suppress any operational concerns you may have during the first 24-hours of ownership! Also listed below are important maintenance recommendations you should observe on a regular basis to protect your new investment.

## Automated Spa Operations

Your new hot tub is equipped with an automated “blow-out” cycle that clears all plumbing lines daily to promote maximum water sanitation. Each day at 12:00 PM (noon), pump 2, pump 3 (Maxxus Models Only) and the blower will automatically turn on for a period of one minute, then go off. Then pump 1 will turn on and run for one minute to complete the blow-out cycle. Be aware, the factory programmed blow-out cycle cannot be canceled or altered!

## Maintain Healthy Spa Water

Always maintain your hot tub’s water chemistry within the following parameters as defined by the Association of Pool And Spa Professionals:

<b>pH</b>	<b>7.4-7.6</b>
<b>Free chlorine</b>	<b>3.0-4.0 ppm</b>
<b>Free Bromine</b>	<b>2.0-4.0 ppm</b>
<b>Total Alkalinity</b>	<b>100-120 ppm</b>
<b>Calcium Hardness</b>	<b>150-250 ppm</b>

*Always maintain your spa filter as outlined below to ensure healthy spa water. Refer to pages 58-59 for additional information.*

## Required Filter Maintenance

Your new hot tub is equipped with an advanced MicroClean Plus water filtration system that provides unsurpassed water quality! To ensure maximum water quality at all times, you should replace the filter cartridge every six months, or earlier as necessary. The filter cartridge is designed to be thrown away! Attempts to reuse the filter cartridge may result in the re-release of unwanted particles back into the hot tub. See pages 53-54 for detailed filter cartridge replacement instructions.

## Required Water Replacement

You should replace the hot tub’s water every 3 to 6 months. The frequency depends on a number of variables including frequency of use, number of users, and attention paid to water quality maintenance. You will know it is time for a change when you cannot control sudsing and/or you can no longer get the normal feel or sparkle to the water, even though the key water balance measurements are all within the proper parameters. See pages 58-59 for additional information.



## Table of Contents

<b>1.0</b>	<b>Important Hot Tub Owner Information</b> .....	<b>1</b>
<b>2.0</b>	<b>Important safety instructions</b> .....	<b>2</b>
<b>3.0</b>	<b>Locating Your Sundance Hot Tub</b> .....	<b>7</b>
3.1	Outdoor Location .....	7
3.2	Indoor Location .....	8
<b>4.0</b>	<b>General Electrical Safety Instructions</b> .....	<b>9</b>
<b>5.0</b>	<b>Electrical Installation Instructions (240V Service)</b> .....	<b>9</b>
<b>6.0</b>	<b>Maxxus Power Requirements</b> .....	<b>13</b>
<b>7.0</b>	<b>Altamar/Cameo/Capri/Marin/Majesta/Optima Power Requirements</b> .....	<b>14</b>
<b>8.0</b>	<b>Hot Tub Fill Up Procedure</b> .....	<b>15</b>
<b>9.0</b>	<b>Hot Tub Features (All Models)</b> .....	<b>20</b>
9.1	Main Control Panel Functions .....	20
9.2	LCD Screen Functions .....	21
<b>10.0</b>	<b>Operating Instructions</b> .....	<b>29</b>
10.1	View Button.....	29
10.2	Light Button (Main Control Panel).....	29
10.3	AquaTerrace™ Light Control Panel .....	29
10.4	Air Injection .....	30
10.5	Activate Jets Pump 1 .....	30
10.6	Activate Jets Pump 2/Pump 3.....	30
10.7	Selecting The Desired Massage Action .....	31
10.8	Adjusting Fluidix Reflex And Intelli-Jets .....	31
10.9	Air Controls .....	32
10.10	Waterfall Control .....	32
10.11	Fragrance Dispenser .....	32
10.12	Optional SunSound™ Audio System .....	33
10.13	Maxxus Massage/Waterfall Selector Diagram .....	34
10.14	Maxxus Air Controls Diagram .....	35
10.15	Optima Massage/Waterfall Selector Diagram .....	36
10.16	Optima Air Controls Diagram .....	37
10.17	Cameo Massage/Waterfall Selector Diagram .....	38
10.18	Cameo Air Controls Diagram .....	39
10.19	Majesta Massage/Waterfall Selector Diagram .....	40



10.20	Majesta Air Controls Diagram .....	41
10.21	Altamar Massage/Waterfall Selector Diagram .....	42
10.22	Altamar Air Controls Diagram .....	43
10.23	Marin Massage/Waterfall Selector Diagram .....	44
10.24	Marin Air Controls Diagram.....	45
10.25	Capri Massage/Waterfall Selector Diagram.....	46
10.26	Capri Air Controls Diagram .....	47
<b>11.0</b>	<b>Heating Modes .....</b>	<b>48</b>
11.1	Standard Mode (Factory Default).....	48
11.2	Economy Mode .....	48
11.3	Selecting Standard or Economy Mode .....	48
11.4	Clean-Up “Blow-Out” Cycle.....	48
<b>12.0</b>	<b>Programming Instructions.....</b>	<b>49</b>
12.1	Programming Filter/Circulation Pump (Standard Mode).....	49
12.2	Programmable Heat Cycles (Economy Mode Only) .....	49
12.3	Adjusting Time of Day.....	51
12.4	Main Control Panel Lock.....	51
12.5	Temperature Setting Lock.....	52
12.6	Programming the Change Filter Reminder .....	52
<b>13.0</b>	<b>Hot Tub Maintenance.....</b>	<b>53</b>
13.1	Replacing the Filter Cartridge .....	53
13.2	Draining And Refilling.....	55
13.3	Cleaning The Hot Tub Interior.....	56
13.4	Pillow Care.....	56
13.5	Maintaining the Synthetic or TerraStone Cabinet.....	56
13.6	Maintaining The Cover.....	57
13.7	Winterizing .....	57
13.8	Restarting Your Hot Tub in Cold Weather .....	58
<b>14.0</b>	<b>Water Quality Maintenance .....</b>	<b>58</b>
14.1	pH Control.....	58
14.2	Sanitizing .....	59
14.3	Other Additives.....	59
14.4	Ozone Water Maintenance System .....	59
14.5	Handrail Maintenance .....	60
<b>15.0</b>	<b>Troubleshooting - Display Messages .....</b>	<b>60</b>
<b>16.0</b>	<b>Troubleshooting - Procedures.....</b>	<b>62</b>



<b>17.0</b>	<b>North American 60Hz Maxxus Electrical Wiring Diagram .....</b>	<b>65</b>
<b>18.0</b>	<b>North American 60Hz Altamar/Cameo/Capri/Majesta/Optima/Marin Electrical Wiring Diagram .....</b>	<b>66</b>
<b>19.0</b>	<b>North American 60Hz Cameo/Optima Electrical Wiring Diagram .....</b>	<b>67</b>
<b>20.0</b>	<b>Export 50Hz Maxxus Electrical Wiring Diagram .....</b>	<b>68</b>
<b>21.0</b>	<b>Circuit Board Pin Assignments .....</b>	<b>69</b>
<b>22.0</b>	<b>Typical Hot Tub Wiring Diagrams A-B (North American 60 Hz Models Only) .....</b>	<b>70</b>
<b>23.0</b>	<b>Optional SunSound™ Stereo Receiver Features.....</b>	<b>71</b>
23.1	SunSound Stereo Receiver Button Controls.....	71
23.2	SunSound Stereo Receiver General Controls .....	71
22.3	SunSound Stereo Receiver Operation.....	72
23.4	SunSound Stereo Receiver Troubleshooting.....	74
23.5	SunSound Stereo Receiver CD Player Operation .....	75
23.6	Stereo Receiver Specifications .....	76
23.7	Standard Wireless Remote Control Functions.....	77
23.8	Wireless Remote Battery Replacement Procedure .....	79
23.9	iPod™ Docking Station .....	80
23.10	Generic MP3 Player Operation .....	81





## 1.0 Important Hot Tub Owner Information

Your Sundance® hot tub is constructed to the highest standards and is capable of providing many years of trouble-free use. However, because heat retentive materials are utilized to insulate the hot tub for efficient operation, an uncovered hot tub surface and wall fittings directly exposed to sunlight and high temperatures for an extended period are subject to permanent damage or discoloration. Damage caused by exposing the hot tub to this abuse is not covered under warranty. We recommend that you always keep the hot tub full of water when it is exposed to direct sunlight and that you keep the Sundance insulating cover in place at all times when the hot tub is not in use. Read and carefully follow the requirements for your hot tub's support base found in the Section 3.0 titled, "Locating Your Sundance Hot Tub" (page 7) or as prescribed by your authorized Sundance Spas dealer.

**Sundance hot tubs constantly strives to offer the finest hot tubs available, therefore, modifications and enhancements may be made which affect the specifications, illustrations and/or instructions contained herein.**

### FCC Notice

This equipment has been tested and found to comply with the limits for a Class B Digital Device, pursuant to Part 15 of the FCC Rules. These limits are designed to provide reasonable protection against harmful interference in a residential installation. This equipment generates, uses and can radiate radio frequency energy and, if not installed and used in accordance with the instructions, may cause harmful interference to radio communications. However, there is no guarantee that interference will not occur in a particular installation. If this equipment does cause harmful interference to radio or television reception, which can be determined by turning the equipment off and on, the user is encouraged to try to correct the interference by one or more of the following measures:

1. Rearrange or relocate the receiving antenna;
2. Increase the separation between the equipment and receiver;
3. Connect the equipment into an outlet on a circuit different from the circuit connected;
4. Consult the dealer or an experienced radio/TV technician for help. (Changes or modifications not expressly approved by the party responsible for FCC compliance could void the user's authority to operate this equipment.)



## 2.0 Important safety instructions

### READ AND FOLLOW ALL INSTRUCTIONS CAREFULLY

When installing and using this electrical equipment, basic safety precautions should always be followed, including:

1. **WARNING:** To reduce the risk of injury, do not permit children to use this product unless they are closely supervised at all times.
2. **WARNING:** A grounding wire connector is provided on this unit to connect a minimum No. 8 AWG (8.4mm<sup>2</sup>) solid copper conductor between this unit and any metal equipment, metal enclosures of electrical equipment, metal water pipe, or conduit within 5 feet (1.5m) of the unit.
3. **DANGER:** Risk of Accidental Drowning. Extreme caution must be exercised to prevent unauthorized access by children. To avoid accidents, ensure that children cannot use this hot tub unless they are supervised at all times.
4. **DANGER:** Risk of Injury. The suction fittings in this spa are sized to match the specific water flow created by the pump. If it is necessary to replace the suction fittings or the pump, be sure that the flow rates are compatible. Because of the risk of injury,
  - Never operate or use the spa if the filter, filter lid, or skimmer assembly are broken or any part of the skimmer assembly is missing. Please contact your dealer or nearest service center for service.
  - Never replace a suction fitting with one rated less than the flow rate marked on the original suction fitting.
5. **DANGER:** Risk of Injury. The suction fittings in this hot tub are sized to match the specific water flow created by the pump. Should the need arise to replace the suction fittings or the pump, be sure that the flow rates are compatible. Never operate the hot tub if the suction fittings are broken or missing. Never replace a suction fitting with one rated less than the flow rate marked on the original suction fitting.
6. **DANGER:** Risk of Electric Shock. Install at least 5 feet (1.5m), from all metal surfaces. As an alternative, a hot tub may be installed within 5 feet of metal surfaces if each metal surface is permanently connected (bonded) by a minimum No. 8 AWG (8.4mm<sup>2</sup>) solid copper conductor attached to the wire connector on the grounding lug, inside the equipment compartment on the equipment box.
7. **DANGER:** Risk of Electric Shock. Do not permit any electrical appliance, such as a lights, telephones, radios, televisions, etc. within 5 feet (1.5m) of a hot tub unless such appliances are built-in by the manufacturer.





8. **Electrical Supply:** The electrical supply for this product must include a suitably rated switch or circuit breaker to open all ungrounded supply conductors to comply with Section 422-20 of the National Electrical Code, ANSI/NFPA 70. The disconnect must be readily accessible and visible to the hot tub occupant but installed at least 5 feet (1.5m), from the hot tub water.
9. **WARNING:** To Reduce the Risk of Injury:
  10. The water in the hot tub should never exceed 104°F (40°C). Water temperatures between 100°F (38°C) and 104°F (40°C) are considered safe for a healthy adult. Lower water temperatures are recommended for young children and when hot tub use may exceed 10 minutes.
  11. Since excessive water temperatures have a high potential for causing fetal damage during the early months of pregnancy, pregnant or possibly pregnant women should limit hot tub water temperatures to 100°F (38°C). If pregnant, please consult your physician before using a hot tub.
  12. Before entering the hot tub, the user should measure the water temperature with an accurate thermometer since the tolerance of water temperature-regulating devices may vary as much as +/- 5°F (2°C).
  13. The use of alcohol, drugs, or medication before or during hot tub use may lead to unconsciousness with the possibility of drowning.
  14. Persons suffering from obesity or a medical history of heart disease, low or high blood pressure, circulatory system problems, diabetes, infectious diseases or immune deficiency syndromes should consult a physician before using a hot tub. If you experience breathing difficulties in association with using or operating your hot tub, discontinue use and consult your physician.
  15. Persons using medication should consult a physician before using a hot tub since some medication may induce drowsiness, while other medication may affect heart rate, blood pressure, and circulation.
  16. Always shower before and after using your hot tub. To reduce the possibility of contracting a waterborne illness, always maintain water chemistry within the parameters listed on the inside cover of this manual. If you or other bathers experience such a condition, discontinue use and seek medical attention.



## **Important CSA safety instructions (Canada only)**

When using this electrical equipment, basic safety precautions should always be followed, including the following:

- 1. READ AND FOLLOW ALL INSTRUCTIONS.**
2. A green colored terminal or a terminal marked G, Gr, Ground, Grounding or the  $\oplus$  symbol\* is located inside the supply terminal box or compartment. To reduce the risk of electric shock, this terminal must be connected to the grounding means provided in the electric supply service panel with a continuous copper wire equivalent in size to the circuit conductors that supply this equipment. \*IEC Publication 417, Symbol 5019.
3. At least two lugs marked “Bonding Lugs” are provided on the external surface or on the inside of the supply terminal box/compartment. To reduce the risk of electric shock, connect the local common bonding grid in the area of the hot tub to these terminals with an insulated or bare copper conductor not smaller than No. 6 AWG (10mm<sup>2</sup>).
4. All field-installed metal components such as rails, ladders, drains or other similar hardware within 10 feet (3m) of the hot tub shall be bonded to the equipment grounding buss with copper conductors not smaller than No. 6 AWG (10mm<sup>2</sup>).
- 5. SAVE THESE INSTRUCTIONS.**

**WARNING:** Children should not use hot tubs without adult supervision.

**WARNING:** Do not use hot tubs unless all suction guards are installed to prevent body and hair entrapment.

**WARNING:** People with infectious diseases should not use a hot tub.

**WARNING:** To avoid injury, exercise care when entering or exiting the hot tub.

**WARNING:** Do not use drugs or alcohol before or during the use of a hot tub to avoid unconsciousness and possible drowning.

**WARNING:** Pregnant or possibly pregnant women should consult a physician before using a hot tub.

**WARNING:** Water temperature in excess of 40°C (104°F) may be injurious to your health.



**WARNING:** Before entering the hot tub, measure the water temperature with an accurate thermometer.

**WARNING:** Do not use a hot tub immediately following strenuous exercise.

**WARNING:** Prolonged immersion in a hot tub may be injurious to your health.

**WARNING:** Do not permit electric appliances (such as lights, telephones, radios, televisions, etc.) within 5 feet (1.5m) of this hot tub unless such appliances are built-in by the manufacturer.

**CAUTION:** Maintain water chemistry in accordance with manufacturer's instructions.

**WARNING:** The use of alcohol or drugs can greatly increase the risk of fatal hyperthermia in hot tubs.

## **SAVE THESE INSTRUCTIONS**

### **HYPERTHERMIA**

Prolonged immersion in hot water may induce hyperthermia. A description of the causes, symptoms, and effects of hyperthermia are as follows:

Hyperthermia occurs when the internal temperature of the body reaches a level several degrees above the normal body temperature of 98.6°F (37°C). The symptoms of hyperthermia include drowsiness, lethargy, and an increase in the internal temperature of the body. The effects of hyperthermia include:

1. Unawareness of impending hazard;
2. Failure to perceive heat;
3. Failure to recognize the need to exit hot tub;
4. Physical inability to exit hot tub;
5. Fetal damage in pregnant women; and
6. Unconsciousness and danger of drowning.

**A warning sign is provided in your warranty packet. Please install it at a location near your hot tub, where it is visible to the user of the hot tub. For additional or replacement signs please contact your local Sundance Hot tubs dealer and reference item number #6530-082.**



## CAUTIONS

1. Persons suffering from heart disease, diabetes, high or low blood pressure, and any condition requiring medical treatment, pregnant women, the elderly, or infants should consult with a physician before using a hot tub.
2. The Consumer Products Safety Commission has stated that the water temperature in a hot tub should not exceed 104°F (40°C). Immersion in water in excess of 104°F (40°C) can be hazardous to your health.
3. Observe a reasonable time limit when using the hot tub. Long exposures at higher temperatures can cause high body temperature. Symptoms may include dizziness, nausea, fainting, drowsiness, and reduced awareness. These effects could possibly result in drowning.
4. Do not use the hot tub under the influence of alcohol, narcotics, or other drugs. Use of the hot tub under these conditions may lead to serious consequences.
5. Always test the hot tub water temperature before entering the hot tub. Enter and exit the hot tub slowly. Wet surfaces can be very slippery.
6. Never bring any electrical appliances into or near the hot tub. Never operate any electrical appliances from inside the hot tub or when you are wet unless such appliances are built-in by the manufacturer.
7. Proper chemical maintenance of hot tub water is necessary to maintain safe water and prevent possible damage to hot tub components.
8. Use the straps and clip tie downs to secure the cover when not in use. This will help to discourage unsupervised children from entering the hot tub and keep the hot tub cover secure in high-wind conditions. There is no representation that the cover, clip tie-downs, or actual locks will prevent access to the hot tub.



### 3.0 Locating Your Sundance Hot Tub

**IMPORTANT:** Because of the combined weight of the spa, water and users, it is extremely important that the base upon which the spa rests be smooth, flat, level and capable of uniformly supporting this weight, without shifting or settling, for the entire time the spa is in place. If the spa is placed on a surface which does not meet these requirements, damage to the skirt and/or the spa shell may result. Damage caused by improper support is not covered under warranty. It is the responsibility of the spa owner to assure the integrity of the support over time. We recommend a poured, reinforced concrete slab with a minimum thickness of 4 inches (10cm). Wood decking is also acceptable provided it is constructed so that it meets the requirements outlined above.

The spa must be installed in such a manner as to provide drainage away from it. Placing the spa in a depression without provisions for proper drainage could allow rain, overflow and other casual water to flood the equipment and create a wet condition in which it would sit in. For spas which will be recessed into a floor or deck, install so as to permit access to the equipment, either from above or below, for servicing. Make certain that there are no obstructions which would prevent removal of all side cabinet panels and access to components, especially on the side with the equipment bay doors.

#### 3.1 Outdoor Location

In selecting the ideal outdoor location for your hot tub, we suggest that you take into consideration the following:

- The proximity to changing area and shelter (especially in regions subject to cold weather).
- The pathway to and from your hot tub (this should be free of debris so that dirt and leaves are not easily tracked into the hot tub).
- The closeness to trees and shrubbery (remember that leaves and birds could create extra work in keeping the hot tub clean).
- A sheltered environment (less wind and weather exposure can result in lowered operation and maintenance costs).
- The overall enhancement of your environment. It is preferable not to place the hot tub under an unguttered roof overhang since run-off water will shorten the life expectancy of the hot tub cover.



### 3.2 Indoor Location

For indoor installations many factors need to be considered before installing a spa indoors:

- **PROPER FOUNDATION:** Consult a Structural Engineer when considering a foundation that will adequately support the spa the entire time it is in place. Proper support is critical especially if the spa is to rest on a second story or higher. For spas that are to rest on balconies, roofs or other platforms not specifically tied into the main structural support, you should consult a professional Structural Engineer with experience in this type of application.
- **PROPER DRAINAGE:** It is extremely important to have in place measures to sufficiently handle excessive water spillage. Be sure the flooring in which the spa rests on has adequate drainage and can handle draining of the entire contents of the spa. Be sure to make provisions for ceilings or any other structures that may be below the spas installation. Areas around your spa can become wet or moist so all flooring and subsequent furniture, walls and adjacent structures should be able to withstand or resist water and moisture.
- **PROPER VENTILATION:** Proper ventilation should be discussed with an Engineer or authority competent enough to understand the necessary provisions needed to vent moist or heated air and air associated with chemical odors outdoors. When the spa is in use considerable amounts of moisture will escape potentially causing mold and mildew, over time this can damage certain surfaces and or surroundings.
- **SUFFICIENT ACCESS:** In the unlikely event that you should ever need to access or gain entry to any portion of the spa for servicing, it is highly recommended that you plan your indoor installation to provide full access to the entire spa.
- **WARRANTY:** Damage caused by not following these guidelines or any improper installation not in accordance with local codes or authorities is not covered under the spas warranty. Please consult your local state or city building ordinances.



**WARNING:** In addition to maintenance of filters and water chemistry, proper ventilation is recommended to reduce the risk of exposure to viruses and bacteria that could be present in the air or water. Consult a licensed architect or building contractor to determine your specific needs if installing your hot tub indoors.



## 4.0 General Electrical Safety Instructions

Your new Sundance® hot tub is equipped with the “state-of-the-art” Sentry™ equipment system. It contains the most advanced safety and self-protective equipment in the industry. Nonetheless, this hot tub must be installed properly to ensure dependable usage. Please contact your local Sundance Spas dealer or local building department should you have any questions regarding your installation.

Proper grounding is extremely important. Sundance hot tubs are equipped with a current collector system. A pressure wire connector is provided on the surface of the control box, located inside the equipment door (Figure-C, page 12) to permit connection of a bonding wire between this point and any ground metal equipment, metal water pipe or conduit within 5 feet (1.5m) of the hot tub, or copper clad grounding rod buried within 5 feet (1.5m) of the hot tub. Bonding wire must be at least No. 8 AWG (8.4mm<sup>2</sup>) solid copper wire. This is a most important safety assurance feature.

Before installing your hot tub, check with your local building department to ensure installation conforms to local building codes.

## 5.0 Electrical Installation Instructions (240V Service)

**IMPORTANT NOTICE:** The electrical wiring of this hot tub must meet the requirements of the National Electrical Code (NEC) and any applicable state or local codes. The electrical circuit must be installed by a qualified electrician and approved by a local building/electrical inspection authority.

1. This hot tub must be permanently connected (hard-wired) to the power supply. **No plug-in connections or extension cords are to be used in conjunction with the operation of this hot tub.** Supplying power to the hot tub which is not in accordance with these instructions will void both the independent testing agency listing and the manufacturer’s warranty.
2. The power supplied to this hot tub must be a dedicated circuit with no other appliances or lights sharing the power provided by the circuit.

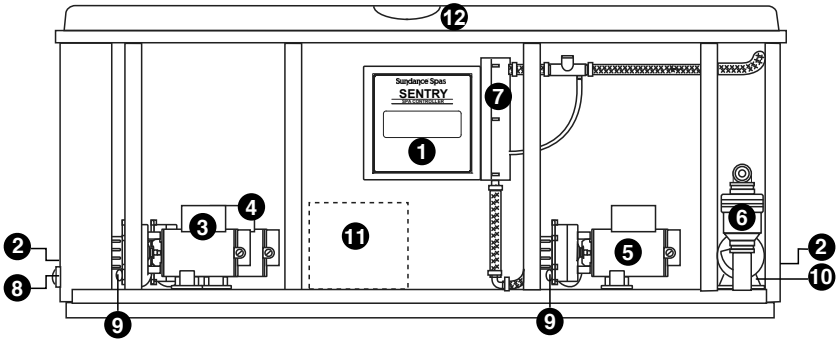


3. To determine the current, voltage and wire size required, refer to Section 6.0-7.0 (pages 13-14) for your specific hot tub model.
  - Wire size must be appropriate per NEC and/or local codes.
  - We recommend type THHN wire.
  - All wiring must be copper to ensure proper connections. **Do not use aluminum wire.**
  - When using wire larger than #6 (10mm<sup>2</sup>), add a junction box near the hot tub and reduce to short lengths of #8 (8.4mm<sup>2</sup>) wire to connect to the hot tub.
4. The electrical supply for this product must include a suitably rated switch or circuit breaker to open all ungrounded supply conductors to comply with Section 422-20 of the National Electrical Code, ANSI/NFPA 70. The disconnecting means must be readily accessible to the hot tub's occupant but installed at least 5 feet (1.5m) from hot tub water.
5. The electrical circuit supplied for the hot tub must include a suitable ground fault circuit interrupter (GFCI) as required by NEC Article 680-42.
6. To gain access to the hot tub's power terminal block, remove the four screws securing the center cabinet panel on the side of the hot tub under the controls. Then remove the four control box door screws and door (Figure C, page 12).
7. Select the power supply entrance you want to use (Figures A-B, page 11) and remove the short cabinet panel from the front of the hot tub, then feed cable through the large opening provided on the bottom of the control box.
8. Connect wires, color to color, on terminal blocks TB1 and TB3 (Figure D, page 12). **TIGHTEN SECURELY!** All wires must be hooked up securely or damage could result.
9. Install control box door and reinstall the cabinet side panels.



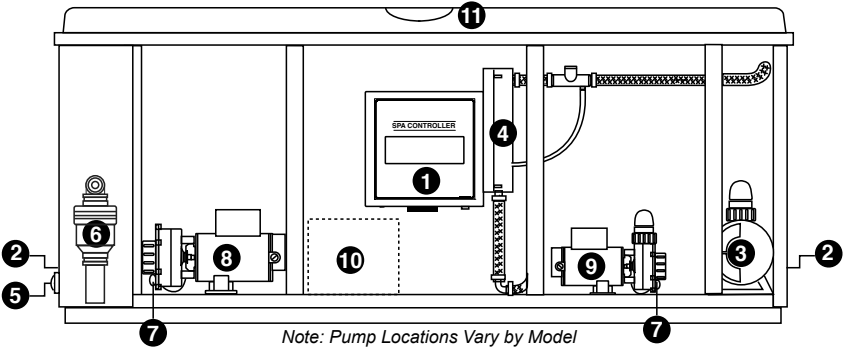


**Figure A (Maxxus Equipment Area)**

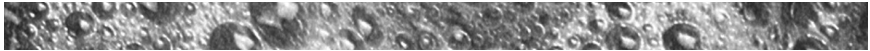


- |                             |   |
|-----------------------------|---|
| 1. Sentry Control Box       | 8. Hot Tub Drain (Removable External Drain Cap)                         |
| 2. Power Supply Entrance(s) | 9. Pump Drain Plug(s)   |
| 3. Jets Pump #1             | 10. Filter/Circulation Pump   |
| 4. Jets Pump #2             | 11. Optional Subwoofer Behind Bulkhead (Models with Audio Option Only.) |
| 5. Jets Pump #3             | 12. Control Panel   |
| 6. Blower                   |   |
| 7. Heater                   |   |

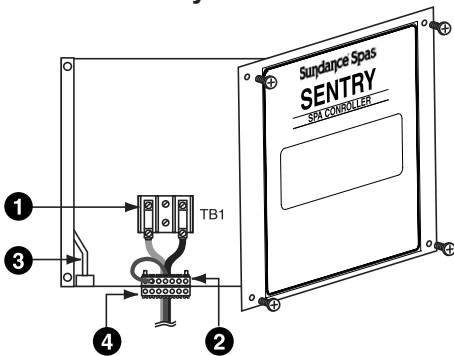
**Figure B (Equipment Area for All Models Except Maxxus)**



- |   |   |
|---|---|
| 1. Sentry Control Box                           | 7. Pump Drain Plug(s)   |
| 2. Power Supply Entrance(s)                     | 8. Jets Pump #2   |
| 3. Jets Pump #1                                 | 9. Filter/Circulation Pump  |
| 4. Heater                                       | 10. Optional Subwoofer Behind Bulkhead (Models with Audio Option Only.) |
| 5. Hot Tub Drain (Removable External Drain Cap) | 11. Control Panel   |
| 6. Air Blower                                   |   |

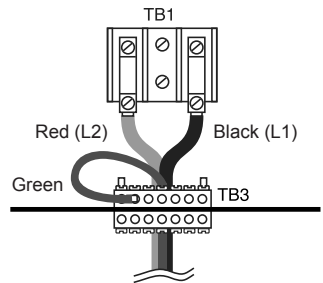


**Figure C**  
**Sentry Control Box**



1. Terminal Block
2. Bonding Lug
3. Receptacle for Optional Ozone Purification System
4. Grounding Terminal

**Figure D**  
**Terminal Block 240V**  
**Wire Connection**





## 6.0 Maxxus Power Requirements

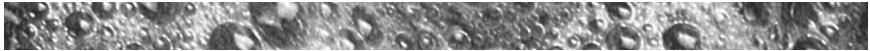
Sundance® hot tubs are designed to provide optimum performance and flexibility of use when connected to their maximum electrical service. However, they are shipped factory configured for their most common preferred electrical connection as follows:

- North American 60Hz Model: 240VAC/60A
- Export 50Hz Model: 230VAC/45A

If you prefer, a qualified technician can perform a minor circuit board modification that allows the hot tub to operate on a different electrical service (see table below).

North American 60Hz Maxxus		
	<u>240V/50A*</u>	<u>240V/60A**</u>
Voltage	240VAC	240VAC
Max. Current Draw	38A	48A
Number of Wires	3	3
Circuit Breaker (2-Pole)	50A*	60A**
* In this configuration, the heater <b><u>will not operate</u></b> while any two jets pumps are running.		
** In this configuration the heater <b><u>will operate while</u></b> any two jets pumps and the blower are running but <b><u>will not operate</u></b> when all three jets pumps are running.		

Export 50Hz Maxxus		
	<u>240V/45A*</u>	<u>240V/50A**</u>
Voltage	230VAC	230VAC
Max. Current Draw	34A	42A
Number of Wires	3	3
Circuit Breaker (2-Pole)	45A*	50A**
* In this configuration, the heater <b><u>will not operate</u></b> while any two jets pumps are running.		
** In this configuration the heater <b><u>will operate while</u></b> any two jets pumps and the blower are running but <b><u>will not operate</u></b> when all three jets pumps are running.		



## 7.0 Altamar/Cameo/Capri/Marin/Majesta/Optima Power Requirements

Sundance hot tubs are designed to provide optimum performance and flexibility of use when connected to their maximum electrical service. However, they are shipped factory configured for their most common preferred electrical connection as follows:

- All North American 60Hz Models: 240VAC/50A\*\*

If you prefer, a qualified technician can perform a minor circuit board modification that allows the hot tub to operate on a different electrical service (see table below).

<b>North American 60Hz Altamar/Cameo/Capri/Marin/Majesta/Optima</b>			
<b><u>Altamar/Cameo/Marin/Majesta/Optima Models</u></b>			
	<b><u>240V/40A*</u></b>	<b><u>240V/50A**</u></b>	<b><u>240V/60A***</u></b>
Voltage	240VAC	240VAC	240VAC
Max. Current Draw	26A	40A	48A
Number of Wires	3	3	3
Circuit Breaker (2-Pole)	40A*	50A**	60A***
* In this configuration, the heater <b><u>will not operate</u></b> while either jets pump is running or when the blower is running.			
** In this configuration, the heater <b><u>will not operate</u></b> while both jet pumps are running.			
*** In this configuration the heater <b><u>will operate while</u></b> both jets pumps and the blower are running.			
<b><u>Capri Models</u></b>			
	<b><u>240V/40A*</u></b>	<b><u>240V/50A**</u></b>	
Voltage	240VAC	240VAC	
Max. Current Draw	26A	40A	
Number of Wires	3	3	
Circuit Breaker (2-Pole)	40A*	50A**	
* In this configuration, the heater <b><u>will not operate</u></b> while either jets pump is running or when the blower is running.			
** In this configuration, the heater <b><u>will operate</u></b> while jets pump are blower are running.			



## 8.0 Hot Tub Fill Up Procedure

**FOR BEST RESULTS, READ EACH STEP IN ITS ENTIRETY BEFORE PROCEEDING WITH THAT STEP.**

### 1. Prepare The Hot Tub For Filling

- Clear all debris from the hot tub. (Although the hot tub shell has been polished at the factory, you may want to treat it with a specially formulated hot tub cleaner. Consult your dealer for additional information prior to filling hot tub.
- Remove filter lid (Figure G-M, pages 22-28), then remove filter cartridge from filter bucket as illustrated in Section 13.1.

### 2. Fill Hot Tub

- Place the end of your garden hose into the empty filter bucket.



**CAUTION:** Never fill with water from a water softener. If your water is extremely “hard”, it is preferable to fill half-way with hard water and the rest of the way with softened water. Or, you may fill entirely with hard water if you use a special water additive available from your Sundance Spas dealer.

- Fill hot tub with clean tap water from garden hose until water covers all jets but does not touch the bottom of the lowest headrest (DO NOT OVERFILL!).



**IMPORTANT:** Always fill your hot tub through the filter bucket after draining. Failure to do so may cause air to be trapped in either pump, preventing the pump from circulating water. Remove the hose and replace the filter cartridge as illustrated in Section 13.1 (pages 53-54).

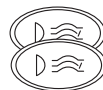
### 3. Turn On Power

Turn on power to hot tub at the home’s circuit breaker to start boot up sequence. The heater and filter/circulation pump will automatically activate. If the control panel LCD flashes water temperature and “COOL” or “ICE”, this is normal. Refer to pages 60-61 for additional information.



#### 4. **Activate Jets Pumps**

Turn on all jet(s) pumps and blower to ensure proper mixing when adding start up chemical in step 5.



#### 5. **Add Start-Up Chemicals**

Add the hot tub water chemicals as recommended by your Sundance Spas dealer. See Section titled “Water Quality Maintenance” (page 58) for general guidance.

#### 6. **Establish A Stable Sanitizer Reading**

Establish a stable sanitizer reading between 3.0-4.0 ppm chlorine or 2.0-4.0 ppm bromine. To ensure healthy water conditions, always maintain a constant sanitizer reading within the levels recommended by the Association of Pool And Spa Professionals printed on the inside cover of this manual. If sanitizer levels cannot be stabilized, perform the decontamination procedure steps 9-15 on the following page. *Note: The “decontamination procedure” steps 9-15 should also be used after the hot tub has been “Winterized” (Section 13.7) or has been sitting without power for an extended period.*

#### 7. **Set Hot Tub To Heat**

To warm hot tub water to a comfortable temperature, follow these steps:

- The LCD display on the control panel displays the actual temperature of the hot tub water. Press either the COOLER (Down) or WARMER (Up) button once to display the “set” temperature for 5 seconds. If you want the water to heat to a different temperature, simply press COOLER or WARMER within 5 seconds. The set temperature increases or decreases by one degree each time either button is pressed.
- The heater will turn off when the temperature corresponding to the thermostat setting is achieved.





#### Important Heater Details:

- The maximum temperature for which the hot tub can be set is 104°F (40°C) and the minimum is 80°F (27°C).
- For Altamar, Cameo, Capri, Optima, Majesta, and Marin hot tubs powered with a 40 amp service, turn off jets pump #1 and jets pump #2 to operate heater.
- Setting the thermostat at maximum will not accelerate the heating process. This will only result in a higher ultimate temperature.
- The heater operates until the water reaches the programmed “set temperature”, then turns off. The heater will reactivate after the water cools to approximately 1° below the “set temperature.”

#### 8. Place Cover On Hot Tub

- Keeping the insulating cover in place anytime the hot tub is not in use will reduce the time required for heating, thereby minimizing operating costs.
- The time required for initial heat-up will vary depending on the starting water temperature.



**DANGER:** Risk of injury, always check water temperature carefully before entering hot tub!

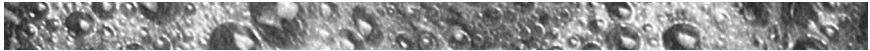
#### Decontamination Procedure (Steps 9-15)

Steps 9-15 below are only required when sanitizer levels are unstable after performing steps 1-6 above. Disregard steps 9-15 below if sanitizer levels remain stable at 3.0-4.0 ppm chlorine or 2.0-4.0 ppm bromine after performing steps 1-6 above.

9. Add 2.5 ounces of sodium dichlor for every 100 gallons of water. Refer to the table (page 18) for approximate water fill volume by model.



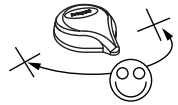
**CAUTION:** Never add chlorine tablets (trichlor) to your hot tub for any reason! This chemical may damage components within your hot tub and void the manufacturer warranty.



### Water Fill Capacity by Model

Model	Approximate Fill Capacity	Sodium Dichlor
Altamar .....	385 US Gallons (1,457 Liters).....	10.0 oz
Cameo .....	450 US Gallons (1,703 Liters).....	11.5 oz
Capri .....	215 US Gallons (814 Liters).....	5.5 oz
Majesta .....	375 US Gallons (1,420 Liters).....	9.5 oz
Marin.....	310 US Gallons (1,173 Liters).....	8.0 oz
Maxxus .....	580 US Gallons (2,196 Liters).....	14.5 oz
Optima .....	485 US Gallons (1,836 Liters).....	12.5 oz

10. Leave hot tub cover open during this step to allow excessive chemical vapors to exit hot tub, protecting pillows and plastic knobs from chemical attack. If hot tub is indoors, open doors and windows for proper ventilation. Turn on all hot tub jets pumps for one hour, open all air controls, turn on the blower, and place all massage selector knob(s) in their center “combo” position as shown (right). *Note: You will need to press the jets pump button(s) and blower button every 20 minutes since these functions have an automatic 20 minute time-out function that turns them off.*



**CAUTION:** Never leave your hot tub unattended for any reason while the cover is open and accessible to small children and animals!

11. Turn off power to the hot tub at the circuit breaker, then drain tub as outlined in Section 13.2 (page 55).
12. Refill hot tub with clean tap water from garden hose until water covers all jets but does not touch the bottom of the lowest headrest (DO NOT OVERFILL!).



**CAUTION:** Never fill with water from a water softener. If your water is extremely “hard”, it is preferable to fill half-way with hard water and the rest of the way with softened water. Or, you may fill entirely with hard water if you use a special water additive available from your Sundance Spas dealer.





13. Consult your authorized Sundance Spas dealer for chemical recommendations, then add chemicals to hot tub water to achieve a constant sanitizer reading within the levels recommended by the Association of Pool And Spa Professionals printed on the inside cover of this manual.
14. Turn on all jet pumps and the blower when adding chemicals to ensure proper mixing and leave your hot tub cover open until the sanitizer level falls below 4.0 ppm to protect pillows and plastic knobs from chemical attack.



**CAUTION:** Never leave your hot tub unattended for any reason while the cover is open and accessible to small children and animals!



**CAUTION:** To prevent the unlikely possibility of contracting a waterborne illness, maintain water chemistry within step 6 parameters. If you or other bathers experience such a condition, discontinue use and seek medical attention.

15. Establish a sanitizer reading between 3.0-4.0 ppm chlorine or 2.0-4.0 ppm bromine , then allow the hot tub to set undisturbed for 8 hours. Retest water after 8 hours to determine if sanitizer levels are stable. If sanitizer levels are stable, your hot tub is ready for use. To ensure healthy water conditions, always maintain a constant sanitizer reading within the levels recommended by the Association of Pool And Spa Professionals printed on the inside cover of this manual. If sanitizer levels are not stable at this time, it will be necessary to repeat this procedure in its entirety (steps 1-15) until stable sanitizer readings are achieved.
16. After adequate sanitizer levels are achieved, close all spa air controls by rotating them clockwise to maximize heat retention when spa is not in use.



## 9.0 Hot Tub Features (All Models)

### 9.1 Main Control Panel Functions

A. **Select Button:** Scrolls menu through filter cycle programming features. Manually activates the Circulation pump when it is in an off state for a 1 hour duration.

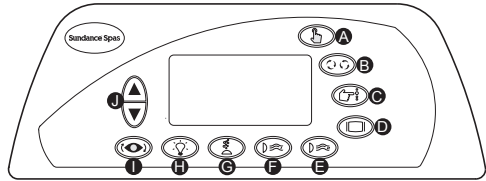


Figure E  
2 or 3 Pump Spa Control Panel

B. **Cycle Button:** Accesses filter cycle program mode and advances display to next cycle.

C. **Mode Button:** Switches between standard and economy modes.

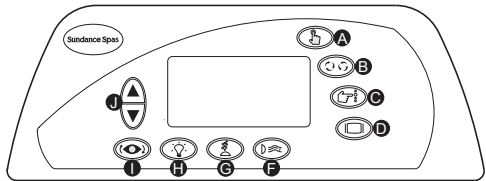


Figure F  
1 Pump Spa Control Panel

D. **Display Button:** Displays time of day and initiates time setting and locking functions.

E. **Jets 2 Button:** Controls jets pump #2 (and Maxxus Jets pump #3).

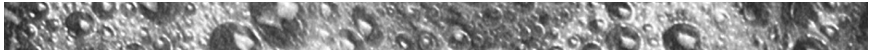
F. **Jets 1 Button:** Controls jets pump #1.

G. **Blower Button:** Controls air blower.


H. **Light Button:** Controls hot tub footwell and waterfall light.


I. **Invert Button:** Inverts the main 4-digit LCD display.


J. **Warmer (▲) and Cooler (▼) Buttons:** These buttons display and increase or decrease temperature setting and other programming features.





## 9.2 LCD Screen Functions

 = Lock: Indicates panel, set temperature, or filter cycle programming is locked.


 = Heat: Indicates heater is on.


 = Ozone: Indicates optional CD ozonator is on (page 59).


 = Adjust Filter Cycle: Indicates filter cycle programming feature is accessed.

 = Filter Cycle Number: Indicates which programmed filter cycle is running.


 = Filter Cycle: Indicates programmed filter cycle is running.

 = Filter Cycle Start Time: Indicates filter cycle start time programming is accessed.

 = Filter Cycle Duration: Indicates filter cycle duration programming is accessed.

 = Set Temperature: Indicates current set temperature is displayed.

 = Set Time: Indicates current time is displayed.

 = Filter Annunciator: Indicates filter cleaning and/or replacement is required.

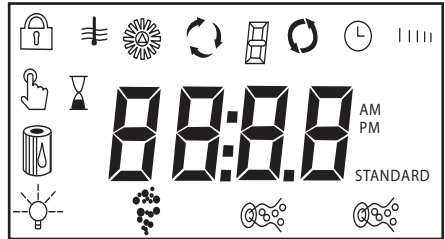
 = Light: Indicates light is on.

 = Blower: Indicates blower is on.

 = Jets 1: Indicates jets pump 1 is on.

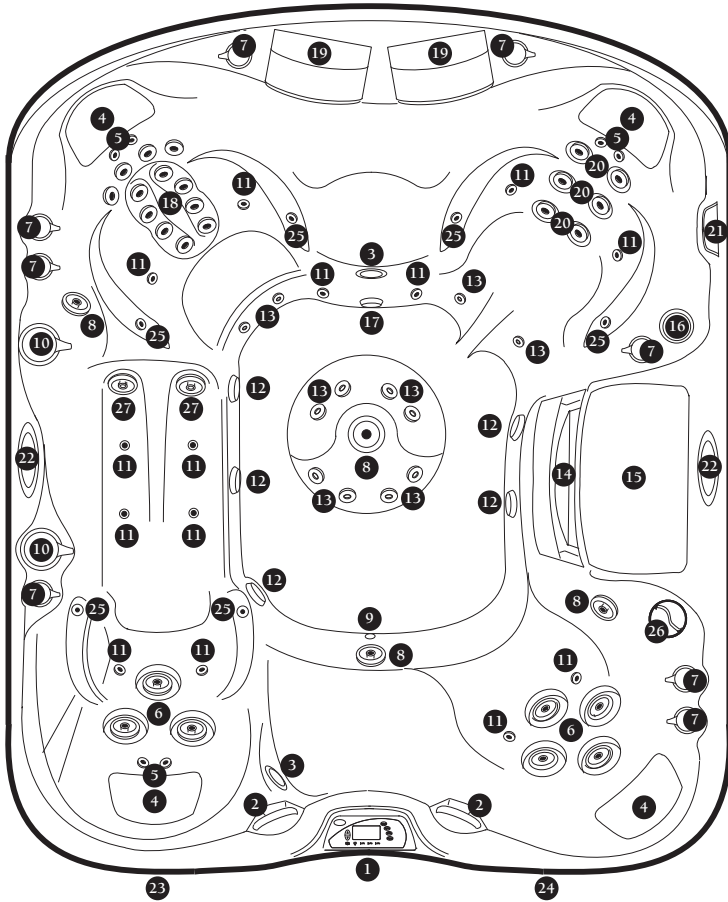
 = Jets 2: Indicates jets pump 2 is on (also shown for Maxxus Pump 3).

STANDARD = Mode: Indicates selected filter mode. *Note: No icon means Economy mode is selected.*





**Figure G (Maxxus Hot Tub Features)**



- |   |   |
|---|---|
| <ol style="list-style-type: none"> <li>1. Main Control Panel</li> <li>2. Handrails (2 ea.)</li> <li>3. Lights (2 ea.)</li> <li>4. Pillows (4 ea.)</li> <li>5. Fluidix Euro Jets (6 ea.)</li> <li>6. Fluidix Intelli-Jets (7 ea.)</li> <li>7. Air Controls (8 ea.)</li> <li>8. Whirlpool Jets (4 ea.)</li> <li>9. Gravity Drain</li> <li>10. Massage Selectors (2 ea.)</li> <li>11. Air Injectors (14 ea.)</li> <li>12. Footwell Suction Covers (5 ea.)</li> <li>13. Accu-Pressure Jets (12 ea.)</li> <li>14. Weir Gate/Skimmer</li> <li>15. Filter Lid (The filter cartridge and suction fitting/filter are located under the filter lid. The suction fitting filter requires periodic</li> </ol> | <ol style="list-style-type: none"> <li>cleaning for optimum performance)</li> <li>16. AquaTerrace Waterfall Control Valve</li> <li>17. AquaTerrace Waterfall Filtration Return</li> <li>18. Fluidix ST Jets (12 ea.)</li> <li>19. AquaTerrace Waterfalls (2 ea.)</li> <li>20. Fluidix Reflex Jets (6 ea.)</li> <li>21. AquaTerrace Waterfall/Footwell Light Control</li> <li>22. Optional Audio System Speakers (2 ea.)</li> <li>23. Optional Audio System Receiver</li> <li>24. Optional iPod Docking Station</li> <li>25. Pulsator Jets (6 ea.)</li> <li>26. Sunscents™ Dispenser</li> <li>27. Vortex Jets (2 ea.)</li> </ol> |
|---|---|

*Spa features subject to change without notice.*

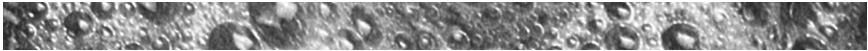
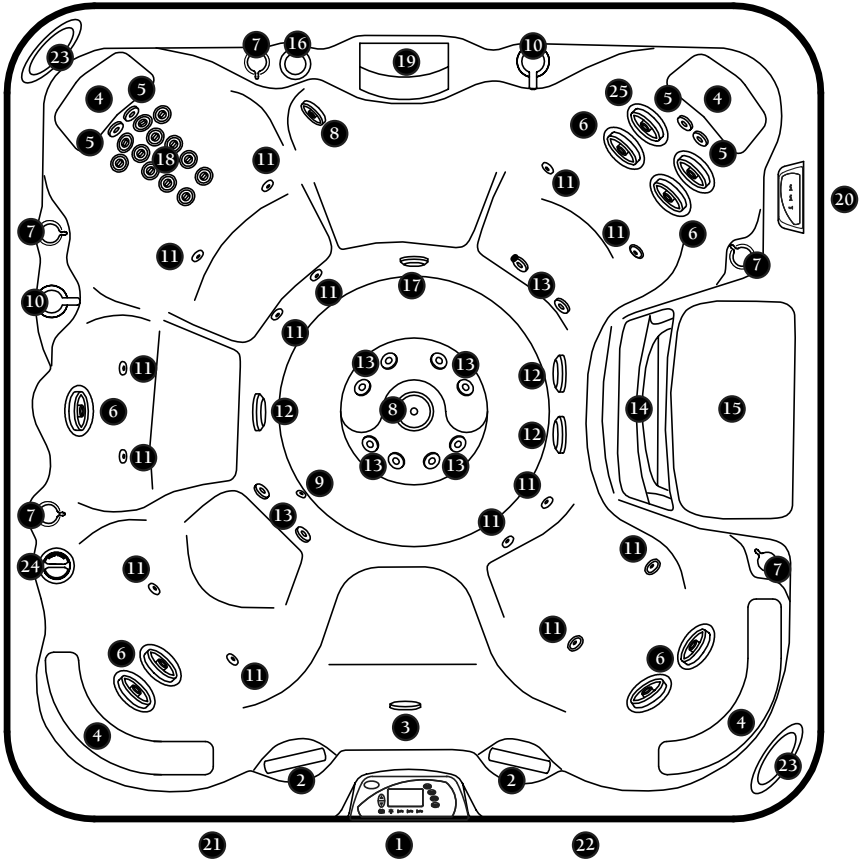


Figure H (Optima Hot Tub Features)

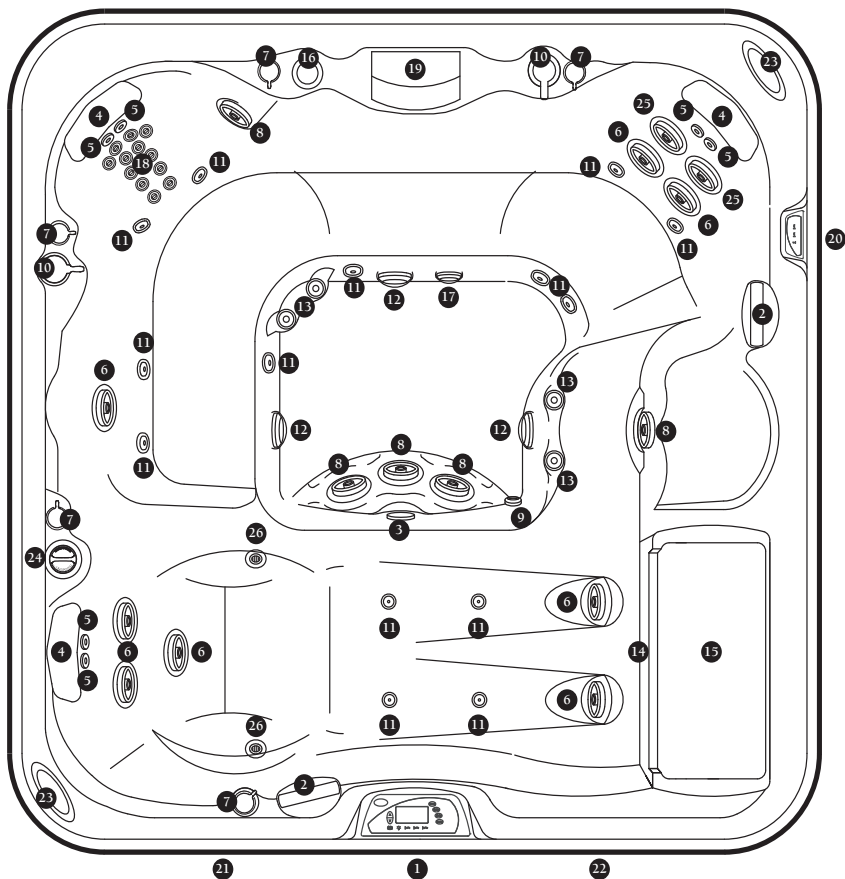


- |  |  |
|--|--|
| <ol style="list-style-type: none"> <li>1. Main Control Panel</li> <li>2. Handrails (2 ea.)</li> <li>3. Light</li> <li>4. Pillows (4 ea.)</li> <li>5. Fluidix Euro Jets (4 ea.)</li> <li>6. Fluidix Intelli-Jets (7 ea.)</li> <li>7. Air Controls (5 ea.)</li> <li>8. Whirlpool Jets (2 ea.)</li> <li>9. Gravity Drain</li> <li>10. Massage Selectors (2 ea.)</li> <li>11. Air Injectors (14 ea.)</li> <li>12. Footwell Suction Covers (3 ea.)</li> <li>13. Accu-Pressure Jets (12 ea.)</li> <li>14. Weir Gate/Skimmer</li> <li>15. Filter Lid (The filter cartridge and suction fitting/filter are located under the filter lid. The suction fitting filter requires periodic cleaning for optimum performance)</li> </ol> | <ol style="list-style-type: none"> <li>16. AquaTerrace Waterfall Control Valve</li> <li>17. AquaTerrace Waterfall Filtration Return</li> <li>18. Fluidix ST Jets (12 ea.)</li> <li>19. AquaTerrace Waterfall</li> <li>20. AquaTerrace Waterfall/Footwell Light Control</li> <li>21. Optional Audio System Receiver</li> <li>22. Optional iPod Docking Station</li> <li>23. Optional Audio System Speakers (2 ea.)</li> <li>24. Sunscents Dispenser</li> <li>25. Vortex Jets (2 ea.)</li> </ol> |
|--|--|

*Spa features subject to change without notice.*



**Figure I (Cameo Hot Tub Features)**

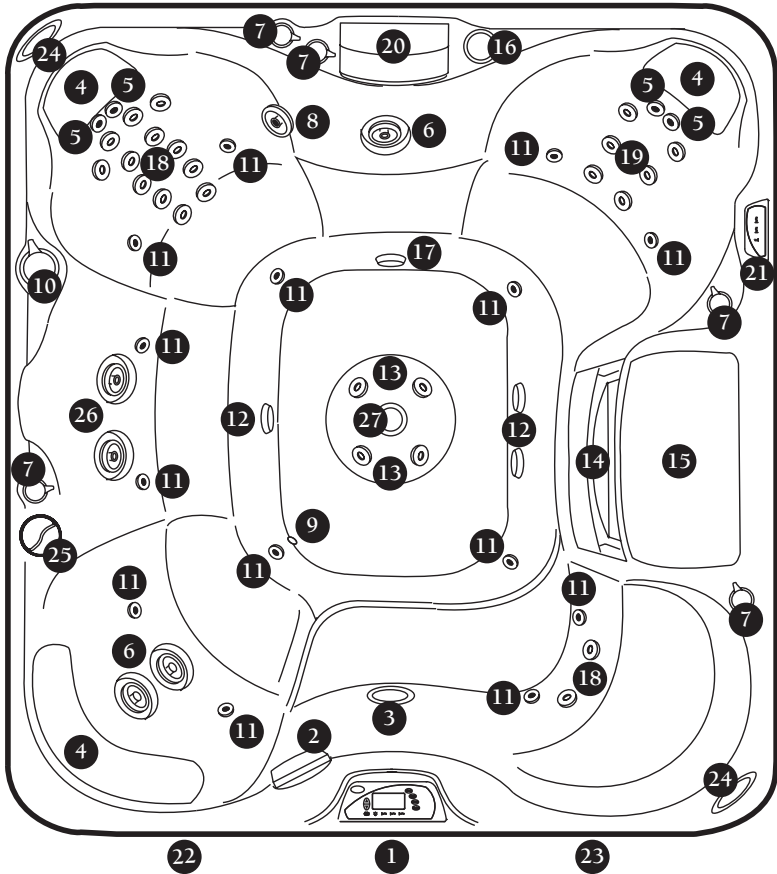


- |  |   |
|--|---|
| <ol style="list-style-type: none"> <li>1. Control Panel</li> <li>2. Handrails (2 ea.)</li> <li>3. Light</li> <li>4. Pillows (3 ea.)</li> <li>5. Fluidix Euro Jets (6 ea.)</li> <li>6. Fluidix Intelli-Jets (8 ea.)</li> <li>7. Air Controls (5 ea.)</li> <li>8. Whirlpool Jets (5 ea.)</li> <li>9. Gravity Drain</li> <li>10. Massage Selectors (2 ea.)</li> <li>11. Air Injectors (14 ea.)</li> <li>12. Footwell Suction Covers (3 ea.)</li> <li>13. Accu-Pressure Jets (4 ea.)</li> <li>14. Weir Gate/Skimmer</li> <li>15. Filter Lid (The filter cartridge and suction fitting/filter are located under the filter lid. The suction fitting filter requires periodic</li> </ol> | <ol style="list-style-type: none"> <li>cleaning for optimum performance)</li> <li>16. AquaTerrace Waterfall Control Valve</li> <li>17. AquaTerrace Waterfall Filtration Return</li> <li>18. Fluidix ST Jets (12 ea.)</li> <li>19. AquaTerrace Waterfall</li> <li>20. AquaTerrace Waterfall Light Control</li> <li>21. Optional Audio System Receiver</li> <li>22. Optional iPod Docking Station</li> <li>23. Optional Audio System Speakers (2 ea.)</li> <li>24. Sunscents Dispenser</li> <li>25. Vortex Jets (2 ea.)</li> <li>26. Pulsator Jets (2 ea.)</li> </ol> |
|--|---|

*Spa features subject to change without notice.*

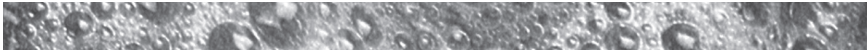


**Figure J (Majesta Hot Tub Features)**

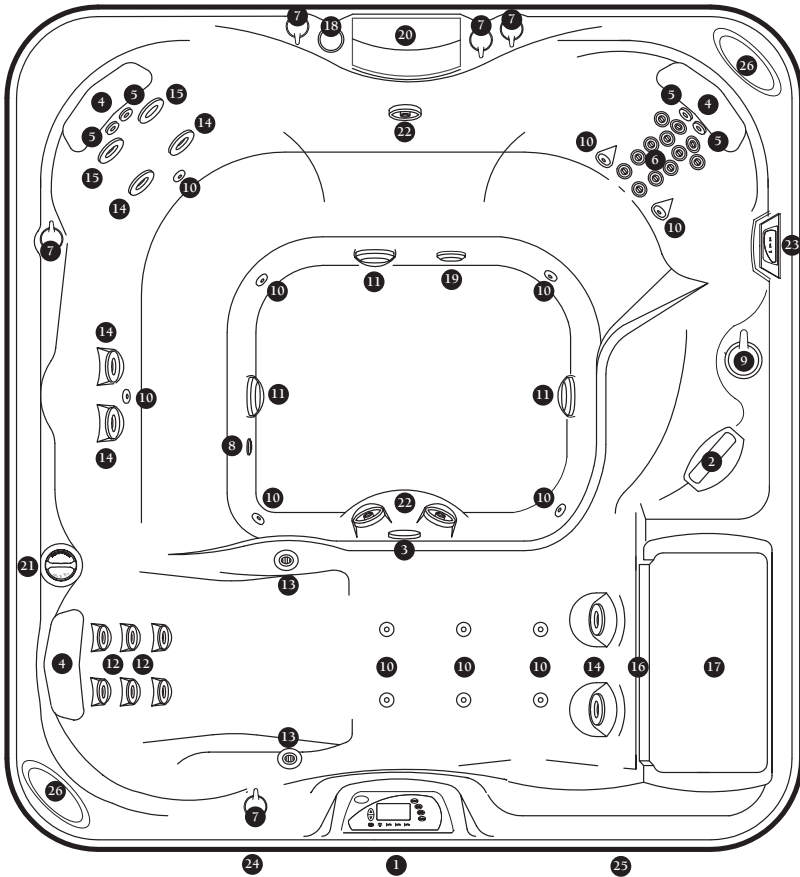


- |  |  |
|--|--|
| <ol style="list-style-type: none"> <li>1. Control Panel</li> <li>2. Handrail</li> <li>3. Light</li> <li>4. Pillows (3 ea.)</li> <li>5. Fluidix Euro Jets (4 ea.)</li> <li>6. Fluidix Intelli-Jets (3 ea.)</li> <li>7. Air Controls (5 ea.)</li> <li>8. Whirlpool Jets (1 ea.)</li> <li>9. Gravity Drain</li> <li>10. Massage Selectors (1 ea.)</li> <li>11. Air Injectors (14 ea.)</li> <li>12. Footwell Suction Covers (3 ea.)</li> <li>13. Accu-Pressure Jets (4 ea.)</li> <li>14. Weir Gate/Skimmer</li> <li>15. Filter Lid (The filter cartridge and suction fitting/filter are located under the filter lid. The suction fitting requires periodic</li> </ol> | <ol style="list-style-type: none"> <li>cleaning for optimum performance)</li> <li>16. AquaTerrace Waterfall Control Valve</li> <li>17. AquaTerrace Waterfall Filtration Return</li> <li>18. Fluidix ST Jets (20 ea.)</li> <li>19. Fluidix Reflex Jets (6 ea.)</li> <li>20. AquaTerrace Waterfall</li> <li>21. AquaTerrace Waterfall Light Control</li> <li>22. Optional Audio System Receiver</li> <li>23. Optional iPod Docking Station</li> <li>24. Optional Audio System Speakers (2 ea.)</li> <li>25. Sunscents Dispenser</li> <li>26. Vortex Jets (2 ea.)</li> <li>27. Pro-Touch II Jets (1 ea.)</li> </ol> |
|--|--|

*Spa features subject to change without notice.*

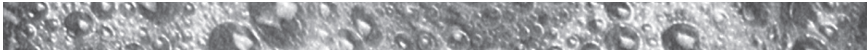


**Figure K (Altamar Hot Tub Features)**

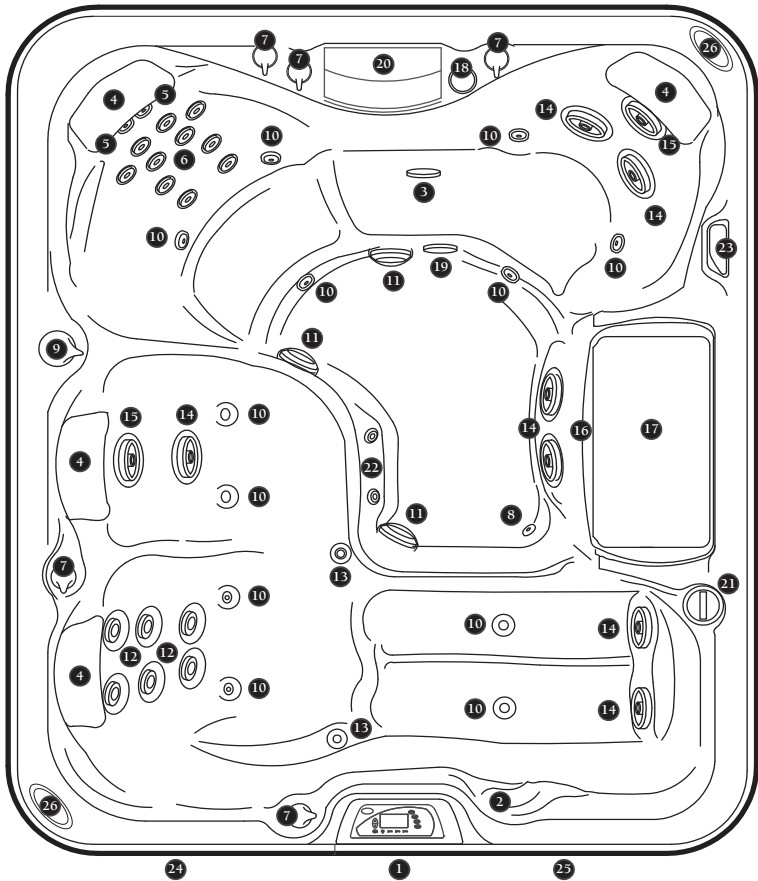


- |   |   |
|---|---|
| <ol style="list-style-type: none"> <li>1. Control Panel</li> <li>2. Handrail</li> <li>3. Light</li> <li>4. Pillows (3 ea.)</li> <li>5. Fluidix Euro Jets (4 ea.)</li> <li>6. Fluidix ST Jets (12 ea.)</li> <li>7. Air Controls (5 ea.)</li> <li>8. Gravity Drain</li> <li>9. Massage Selector (1 ea.)</li> <li>10. Air Injectors (14 ea.)</li> <li>11. Footwell Suction Covers (3 ea.)</li> <li>12. Fluidix Reflex Jets (6 ea.)</li> <li>13. Pulsator Jets (2 ea.)</li> <li>14. Fluidix Intelli-Jets (6 ea.)</li> <li>15. Vortex Jets (2 ea.)</li> <li>16. Weir Gate/Skimmer</li> </ol> | <ol style="list-style-type: none"> <li>17. Filter Lid (The filter cartridge and suction fitting/filter are located under the filter lid. The suction fitting requires periodic cleaning for optimum performance)</li> <li>18. AquaTerrace Waterfall Control Valve</li> <li>19. AquaTerrace Waterfall Filtration Return</li> <li>20. AquaTerrace Waterfall</li> <li>21. Sunscents Dispenser</li> <li>22. Whirlpool Jets (3 ea.)</li> <li>23. AquaTerrace Light Control Panel</li> <li>24. Optional Audio System Receiver</li> <li>25. Optional iPod Docking Station</li> <li>26. Optional Audio System Speakers (2 ea.)</li> </ol> |
|---|---|





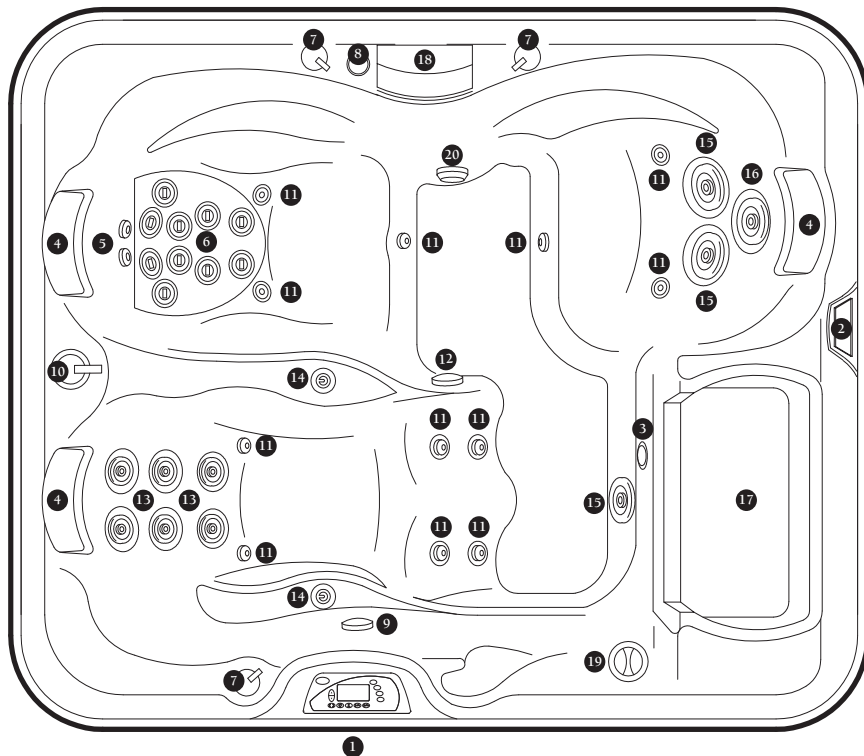
**Figure L (Marin Hot Tub Features)**



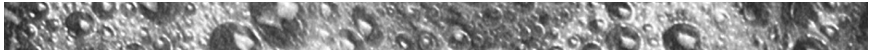
- |  |   |
|--|---|
| <ol style="list-style-type: none"> <li>1. Control Panel</li> <li>2. Handrail</li> <li>3. Light</li> <li>4. Pillows (3 ea.)</li> <li>5. Fluidix Euro Jets (2 ea.)</li> <li>6. Fluidix ST Jets (10 ea.)</li> <li>7. Air Controls (5 ea.)</li> <li>8. Gravity Drain</li> <li>9. Massage Selectors (1 ea.)</li> <li>10. Air Injectors (12 ea.)</li> <li>11. Footwell Suction Covers (3 ea.)</li> <li>12. Fluidix Reflex Jets (6 ea.)</li> <li>13. Pulsator Jets (2 ea.)</li> <li>14. Fluidix Intelli-Jets (7 ea.)</li> <li>15. Vortex Jets (2 ea.)</li> <li>16. Weir Gate/Skimmer</li> </ol> | <ol style="list-style-type: none"> <li>17. Filter Lid (The filter cartridge and suction fitting/filter are located under the filter lid. The suction fitting requires periodic cleaning for optimum performance)</li> <li>18. AquaTerrace Waterfall Control Valve</li> <li>19. AquaTerrace Waterfall Filtration Return</li> <li>20. AquaTerrace Waterfall</li> <li>21. Sunscents Dispenser</li> <li>22. Accu-Pressure Jets (2 ea.)</li> <li>23. AquaTerrace Waterfall Light Control</li> <li>24. Optional Audio System Receiver</li> <li>25. Optional iPod Docking Station</li> <li>26. Optional Audio System Speakers (2 ea.)</li> </ol> |
|--|---|



**Figure M (Capri Hot Tub Features)**



- |                                    |   |
|------------------------------------|---|
| 1. Control Panel                   | 16. Vortex Jet (1 ea.)  |
| 2. Integral Handrail               | 17. Filter Lid (The filter cartridge and suction fitting/filter are located under the filter lid. The suction fitting requires periodic cleaning for optimum performance) |
| 3. Gravity Drain                   | 18. AquaTerrace Waterfall   |
| 4. Pillows (3 ea.)                 | 19. SunScents Dispenser   |
| 5. Fluidix Euro Jets (2 ea.)       | 20. Footwell Suction Cover (1 ea.)  |
| 6. Fluidix ST Jets (10 ea.)        | 21. AquaTerrace Light Control Panel   |
| 7. Air Controls (3 ea.)            |   |
| 8. Waterfall Control Valve (1 ea.) |   |
| 9. Light                           |   |
| 10. Massage Selectors (1 ea.)      |   |
| 11. Air Injectors (12 ea.)         |   |
| 12. Waterfall Bypass Fitting       |   |
| 13. Fluidix Reflex Jets (6 ea.)    |   |
| 14. Pulsator Jets (2 ea.)          |   |
| 15. Fluidix Intelli-Jets (3 ea.)   |   |



## 10.0 Operating Instructions

Your Sundance® hot tub has a touch-sensitive control panel, massage selector valves and air control knobs located on the top rim of the hot tub (Figures G-M, pages 22-28). These controls let you operate many of the special functions of your Sundance® hot tub. By familiarizing yourself with the following information, you will be able to gain the full benefit afforded by the various functions of your hot tub.

### 10.1 View Button

Pressing this button inverts the main four-digit display on the Command Center's LCD screen to allow easy reading from either inside or outside the hot tub.



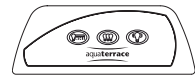
### 10.2 Light Button (Main Control Panel)

Pressing the LIGHT button activates both footwell and waterfall lights in random color mode. Upon startup, both lights quickly advance through all seven colors, then change colors every 4 seconds thereafter. At this time, you can choose one of seven constant colors on the AquaTerrace control panel. Pressing this button a second time turns both lights off. See Section 10.3 below for details.

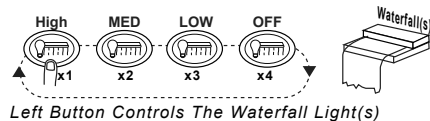


### 10.3 AquaTerrace™ Light Control Panel

The AquaTerrace light control panel offers a variety of light settings described below. *Note: Lights automatically turn off after 2 hours.*

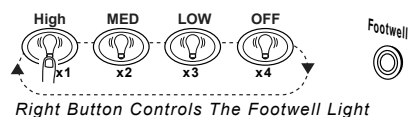


The left button turns on, dims, and turns off the waterfall light(s) as shown.



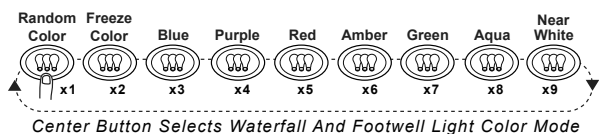
Left Button Controls The Waterfall Light(s)

The right button turns on, dims, and turns off the footwell light as shown.



Right Button Controls The Footwell Light

The center button selects random mode or one of 7 constant colors on the footwell and waterfall lights. In random



Center Button Selects Waterfall And Footwell Light Color Mode



mode, press a second time to freeze random color or continue pressing for one of 7 constant colors. If you go past your favorite color, simply continue pressing to restart the color selection sequence.

#### 10.4 Air Injection

When the **AIR** button is pressed, the air blower forces air through the injectors located in the seats and footwell. The bubbles symbol on the button appears on the LCD whenever the air blower is on. An electronic timer automatically turns the air blower off 20 minutes after it was turned on. *Note: The air blower automatically activates for 1 minute at the start of the clean-up cycle at 12:00 (Noon). This clears the lines of the air injector system to help ensure that all water is exposed to sanitizer. This cycle is non-programmable.*



#### 10.5 Activate Jets Pump 1

This button controls jets pump #1. Press once to turn on jets pump #1. Press a second time to turn pump off.



#### 10.6 Activate Jets Pump 2/Pump 3

On two pump models, this button controls jets pump #2. Press once to turn on jets pump #2. Press a second time to turn pump off.



On three pump Maxxus models, this button controls both jets pump #2 and jets pump #3 in the following sequence:



- A. Press once to turn on jets pump #2.
- B. Press a second time to turn on jets pump #3.
- C. Press a third time to turn off jets pump #2.
- D. Press a fourth time to turn off jets pump #3.

*Note: Anytime a jet pump has been manually activated, it will automatically turn off after approximately 20 minutes. If at this time you desire more jet operation you may simply turn the pump(s) back on.*



## 10.7 Selecting The Desired Massage Action

Your Sundance® hot tub is equipped to allow you to customize the massage action you desire. Each model incorporates a massage selector(s) that allows you to customize the massage and performance by diverting water between various jet systems. Simply turn massage selector to position A (Combo), B, or C to divert water pressure to various jet groups.



*Note: This valve is designed to operate in positions A (Combo), B, and C for optimum performance. It is considered normal for sound levels within the valve to vary between positions due to the large amounts of water flowing through it! For optimum filtration benefits, leave the valve in position A when hot tub is covered. Select position B or C for maximum jet performance during hot tub use.*

## 10.8 Adjusting Fluidix Reflex, ST And Intelli-Jets

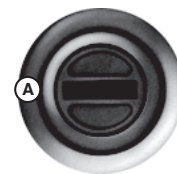
These jets in your new hot tub offer the advantage of no moving parts and zero maintenance. They can also be adjusted for a high and low impact massage, providing the ultimate massage!

### To Adjust Jets

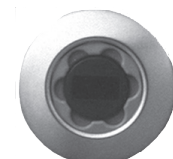
1. Fluidix Intelli-Jet and Reflex only : Turn outer dial (A) clockwise to increase water volume. Turn outer dial counterclockwise to decrease water volume or to shut jet off.
2. Fluidix Intelli-Jet only: Rotate center “mode disk” (B) clockwise to select a non-oscillating water stream or turn counterclockwise to select an oscillating stream at any angle.
3. For a high impact massage, turn corresponding air control knob clockwise. For the Fluidix ST, jet this will create a straight water flow. For low impact massage, turn corresponding air control knob counterclockwise. For the Fluidix ST, jet this will create an oscillating flow. Refer to Sections 10.13-10.26 (pages 34-47) for specific operation details.



Fluidix Intelli-Jet

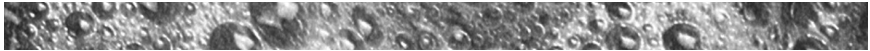


Fluidix Reflex Jet



Fluidix ST Jet

*Note: Always keep at least 6 adjustable jets open at all times on each jet system.*



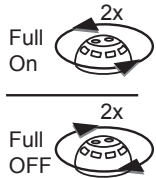
### 10.9 Air Controls

Each jet system has its own air control. These controls allow you to regulate the amount of air which is mixed with the water entering through the jets. Clockwise rotation adds more air and counterclockwise rotation reduces air flow. *Note: To minimize heat loss, close all air controls when spa is not in use. Certain jets may not draw air while either jets pump is running in low speed; this is considered normal.*



### 10.10 Waterfall Control

Turn waterfall control valve counterclockwise to increase waterfall(s) output. Turn control valve clockwise to decrease or turn off waterfall(s) output. *Note: It takes 2 full revolutions to change the waterfall from a full off to a full on flow rate.*



### 10.11 Fragrance Dispenser

On the rim of your hot tub is a screw-off cap labeled “SunScents™ Fragrance Dispenser” (pages 22-28). It is designed to contain packages of a specially made fragrance available from your Sundance Spas dealer. The fragrance is carried into the hot tub water by the air coming through the injector system when the air blower is on.

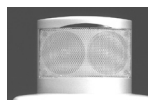


**CAUTION:** To prevent personal injury, always turn off air blower before removing or installing SunScents dispenser cap. Use only Sundance SunScents fragrances in your new hot tub. Never remove the SunScents beads from their plastic cage for any reason! Install bead cage directly into SunScents dispenser. Never use this dispenser for any other type of fragrance. Always make certain that the dispenser cap is securely in place before operating the hot tub’s air blower.



## 10.12 Optional SunSound™ Audio System

Sundance models with the optional audio system offer enhanced hot tub enjoyment by offering an integrated state-of-the-art audio system. These models include a high-quality AM/FM/CD splash-resistant marine stereo receiver, two high-quality marine speakers, iPod Docking Station and integrated sub woofer for excellent sound quality. Two speakers located on the top of the hot tub shell (Figures G-M, pages 22-28) are designed for manual extension and retraction. To expose each speaker for audio playback, simply press down on each enclosure to unlatch its “pop-up” mechanism, then release. To retract each speaker before covering hot tub, gently press downward on each enclosure until you feel a slight “click”, then release. Refer to Section 22.0 (page 70) for complete stereo operation details.



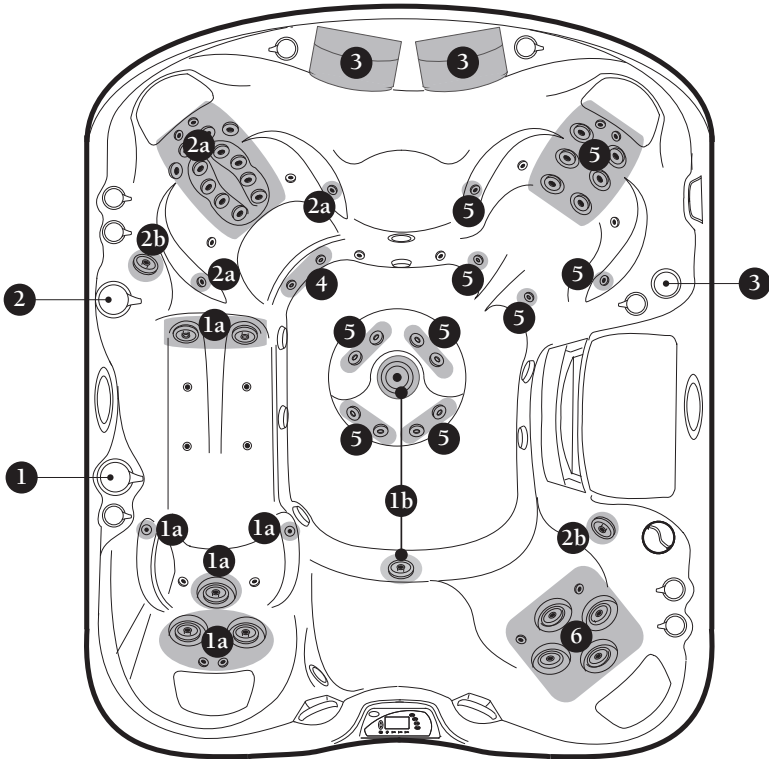
**CAUTION:** Never step or sit on a speaker enclosure! This type of misuse will damage the speaker enclosure latching and track mechanism. Always retract speakers prior to covering hot tub.



## 10.13 Maxxus Massage/Waterfall Selector Diagram

### Massage Selector Operation

Rotate Massage Selectors 1 & 2 to divert water between designated jet groups.



#### Massage Selectors (1-2)

- Massage Selector #1 controls pump #1.
- Massage Selector #2 controls pump #2.

#### Waterfall Selector (3)

- Waterfall Selector #3 controls waterfall output.

#### Continuously Powered Jets (4-6)

- Jets #6 are always on when jets pump #1 is running.
- Jets #4 are always on when jets pump #2 is running.
- Jets #5 are always on when jets pump #3 is running.

*Spa operation subject to change without notice.*

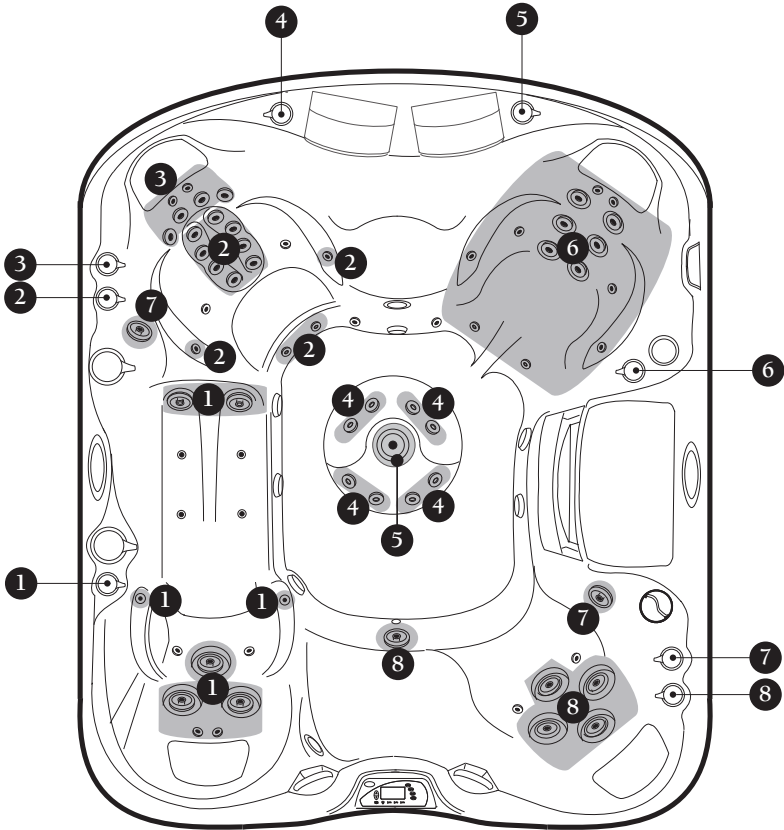




## 10.14 Maxxus Air Controls Diagram

### Air Control Operation

Rotate Air Controls 1-8 to add air to designated jet groups.



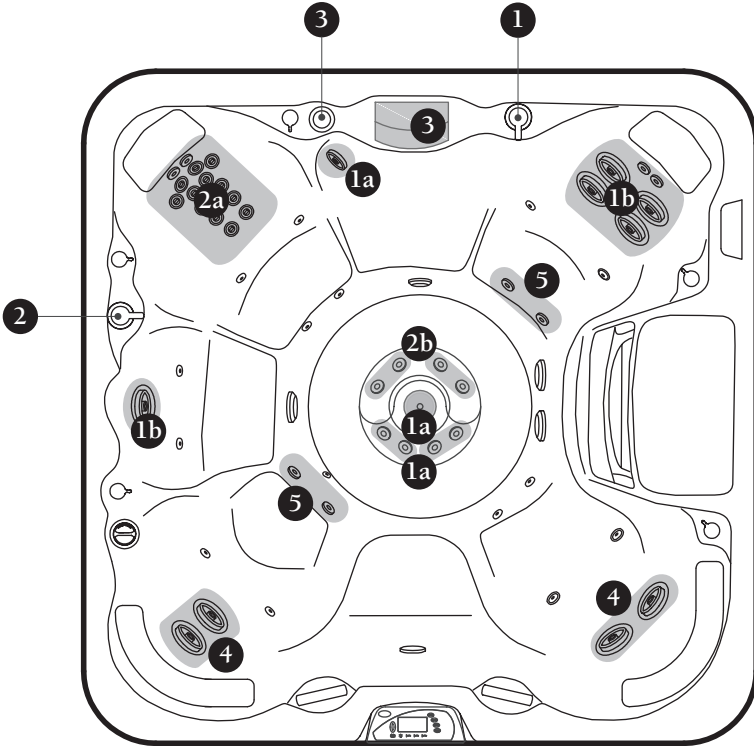
*Spa operation subject to change without notice.*



## 10.15 Optima Massage/Waterfall Selector Diagram

### Massage Selector Operation

Rotate Massage Selectors 1 & 2 to divert water between designated jet groups.



#### Massage Selectors (1-2)

- Massage Selector #1 controls pump #1.
- Massage Selector #2 controls pump #2.

#### Waterfall Selector (3)

- Waterfall Selector #3 controls waterfall output.

#### Continuously Powered Jets (4-5)

- Jets #4 are always on when jets pump #1 is running.
- Jets #5 are always on when jets pump #2 is running.

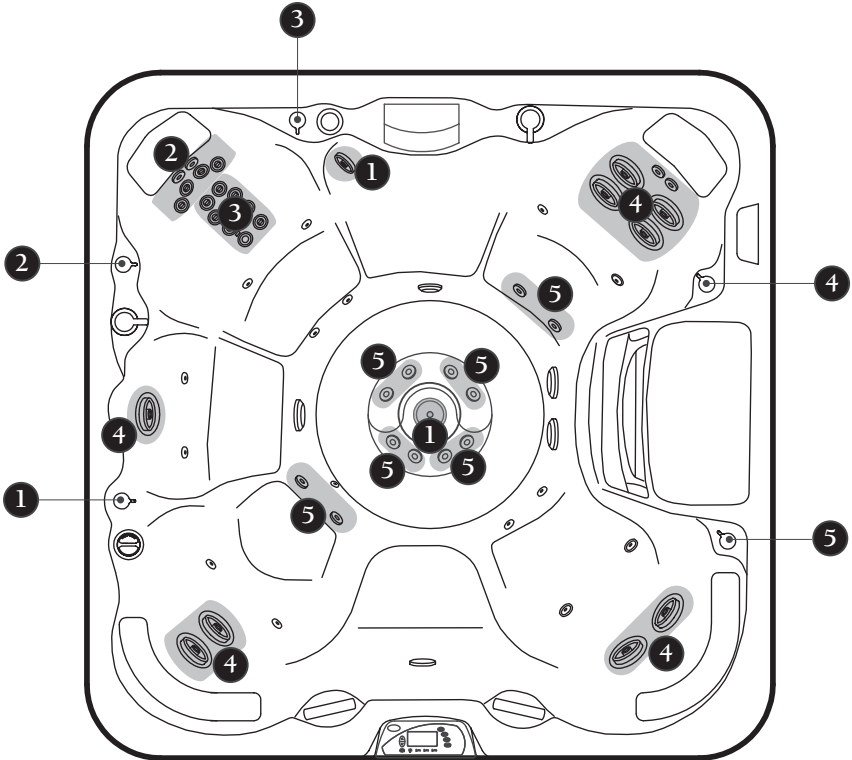
*Spa operation subject to change without notice.*



## 10.16 Optima Air Controls Diagram

### Air Control Operation

Rotate Air Controls 1-5 to add air to designated jet groups.

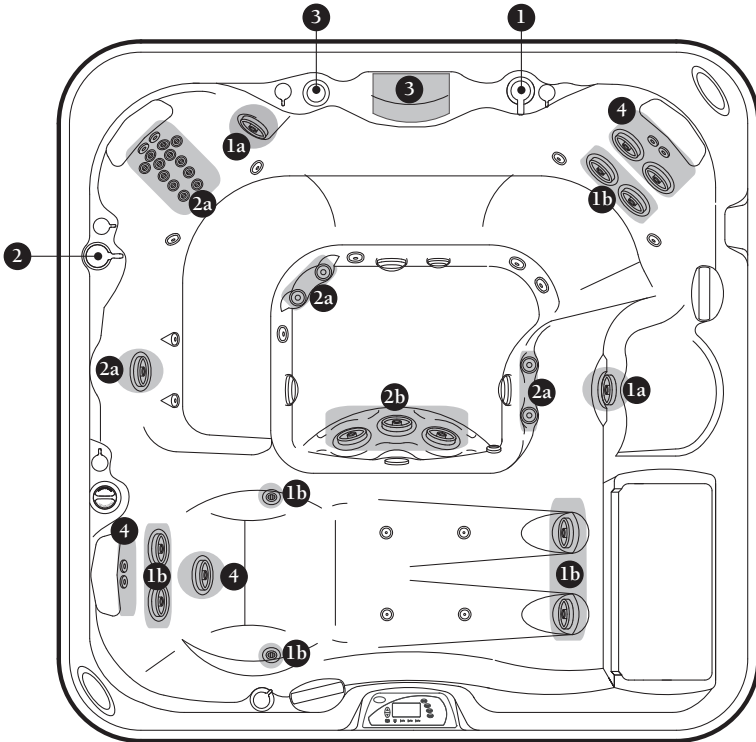




## 10.17 Cameo Massage/Waterfall Selector Diagram

### Massage Selector Operation

Rotate Massage Selectors 1 & 2 to divert water between designated jet groups.



#### **Massage Selectors (1-2)**

- Massage Selector #1 controls pump #1.
- Massage Selector #2 controls pump #2.

#### **Waterfall Selector (3)**

- Waterfall Selector #3 controls waterfall output.

#### **Continuously Powered Jets (4)**

- Jets #4 are always on when jets pump #1 is running.

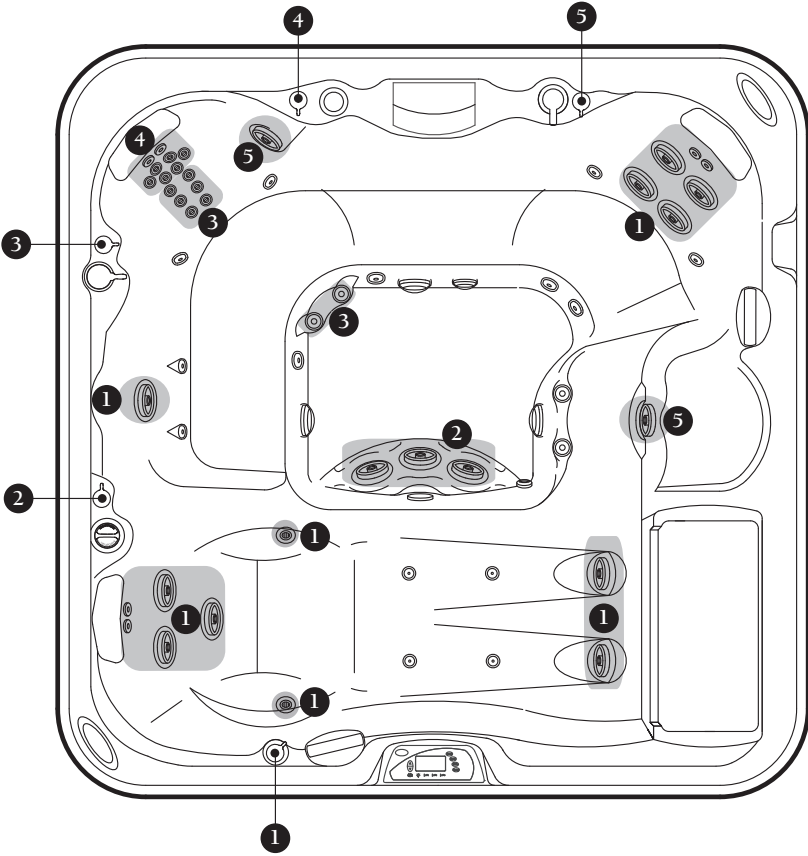
*Spa operation subject to change without notice.*



## 10.18 Cameo Air Controls Diagram

### Air Control Operation

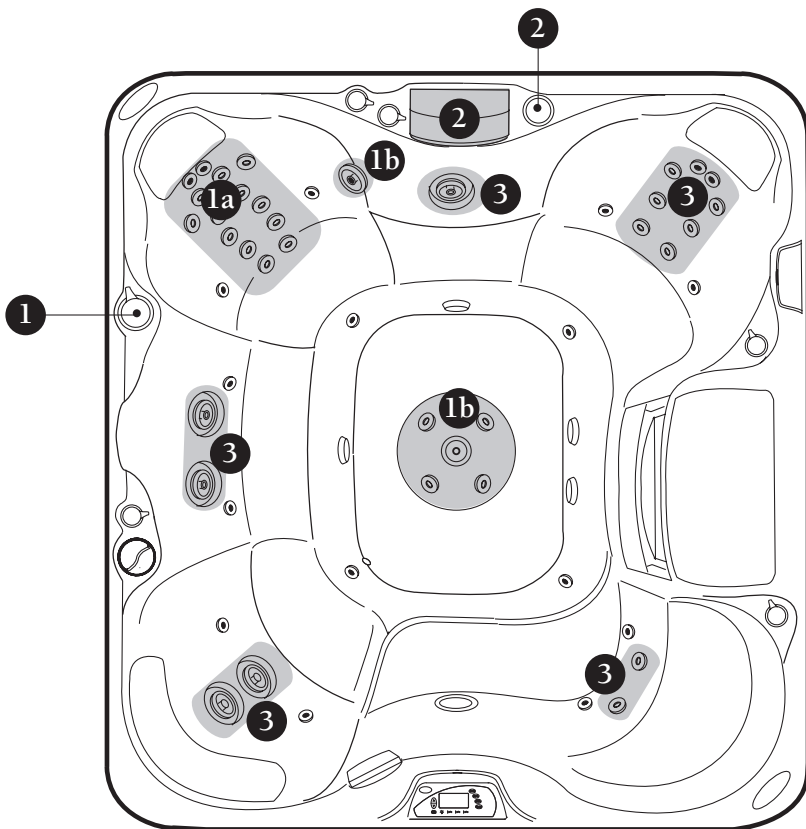
Rotate Air Controls 1-5 to add air to designated jet groups.





## 10.19 Majesta Massage/Waterfall Selector Diagram

**Massage Selector Operation**  
*Rotate Massage Selector 1 to divert water between designated jet groups.*



### **Massage Selectors (1)**

- *Massage Selector #1 controls pump #1.*

### **Waterfall Selector (2)**

- *Waterfall Selector #2 controls waterfall output.*

### **Continuously Powered Jets (3)**

- *Jets #3 are always on when jets pump #2 is running.*

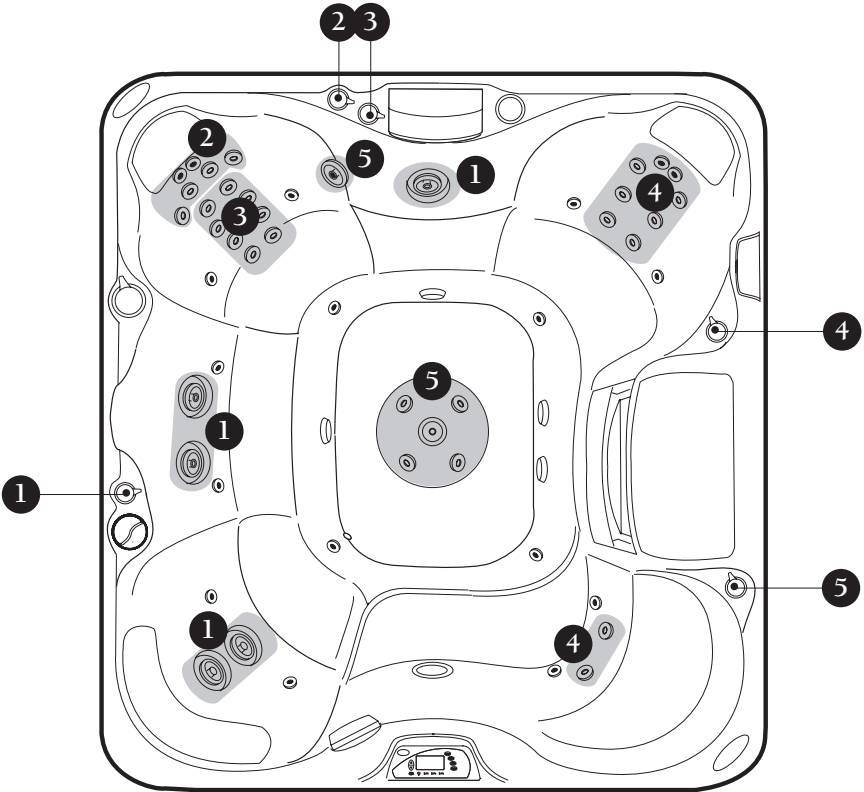
*Spa operation subject to change without notice.*



## 10.20 Majesta Air Controls Diagram

### Air Control Operation

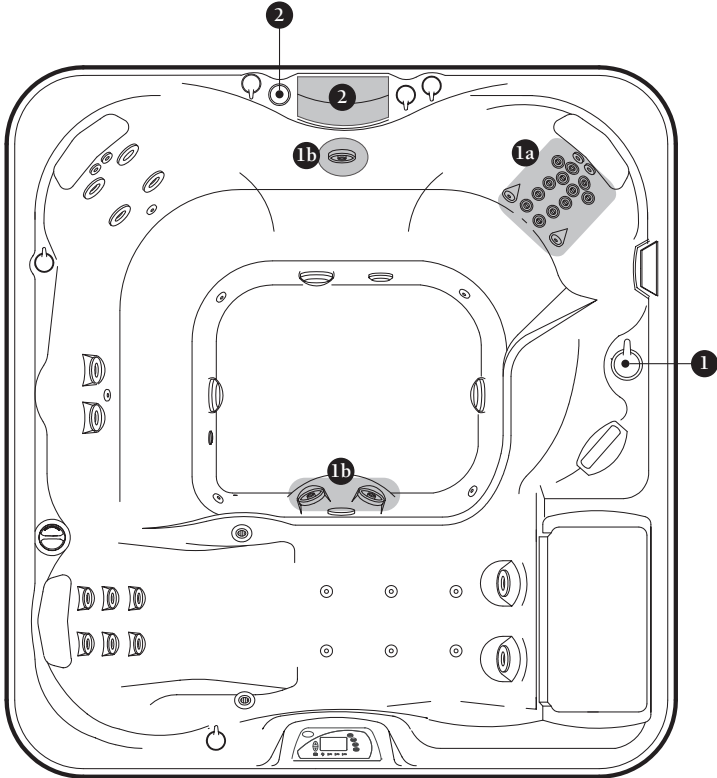
Rotate Air Controls 1-5 to add air to designated jet groups.





## 10.21 Altamar Massage/Waterfall Selector Diagram

**Massage Selector Operation**  
*Rotate Massage Selector 1 to divert water between designated jet groups.*



### **Massage Selectors (1)**

- *Massage Selector #1 controls pump #2.*

### **Waterfall Selector (2)**

- *Waterfall Selector #2 controls waterfall output.*

### **Continuously Powered Jets**

- *All unmarked jets are always on when pump #1 is running*

*Spa operation subject to change without notice.*

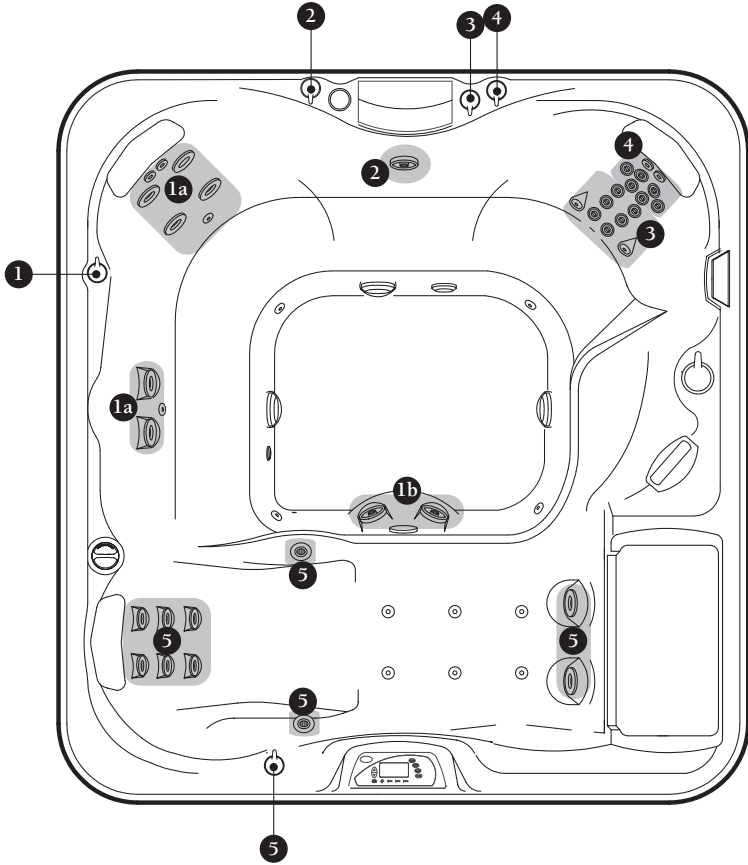




## 10.22 Altamar Air Controls Diagram

### Air Control Operation

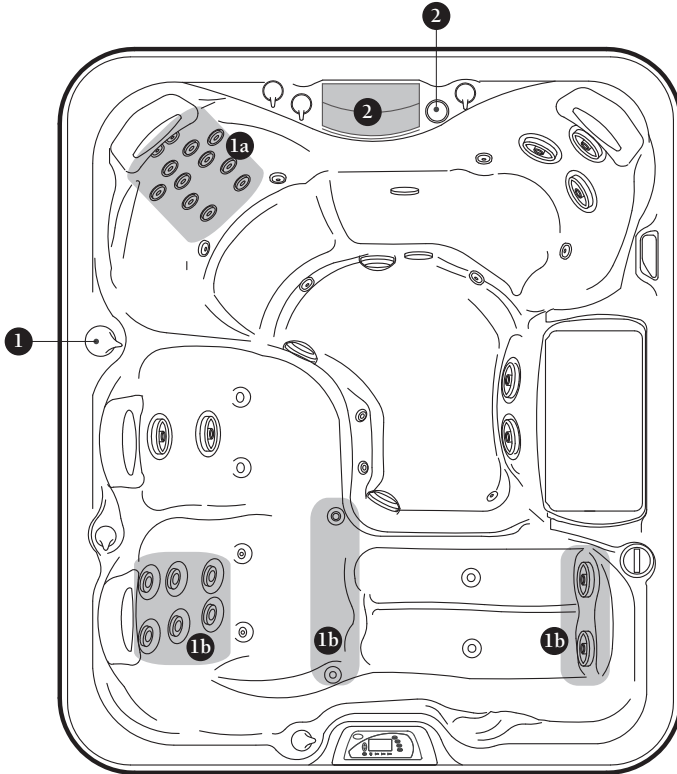
Rotate Air Controls 1-5 to add air to designated jet groups.



*Spa operation subject to change without notice.*

## 10.23 Marin Massage/Waterfall Selector Diagram

**Massage Selector Operation**  
*Rotate Massage Selector 1 to divert water between designated jet groups.*



### **Massage Selectors (1)**

- *Massage Selector #1 controls pump #1.*

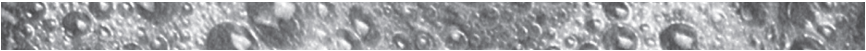
### **Waterfall Selector (2)**

- *Waterfall Selector #2 controls waterfall output.*

### **Continuously Powered Jets**

- *All unmarked jets are always on when pump #2 is running*

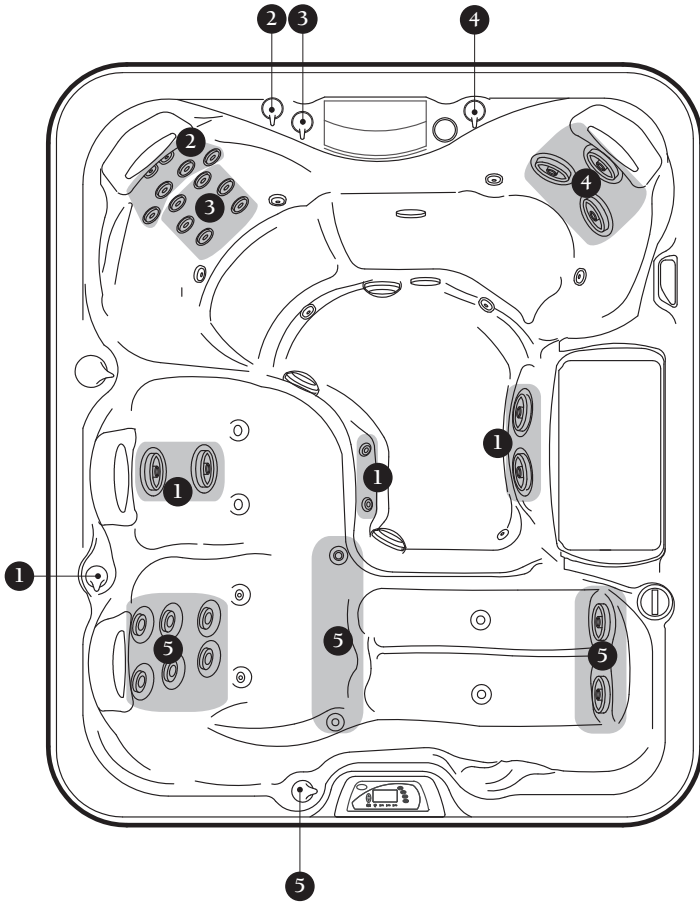
*Spa operation subject to change without notice.*



## 10.24 Marin Air Controls Diagram

### Air Control Operation

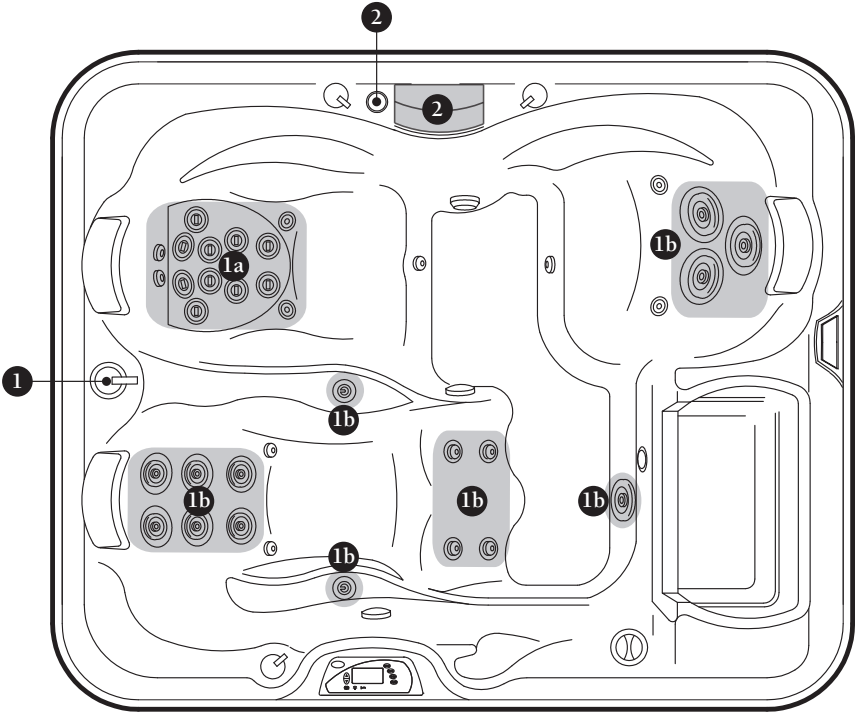
Rotate Air Controls 1-5 to add air to designated jet groups.





## 10.25 Capri Massage/Waterfall Selector Diagram

**Massage Selector Operation**  
*Rotate Massage Selector 1 to divert water between designated jet groups.*



### **Massage Selectors (1)**

- *Massage Selector #1 controls pump #1.*

### **Waterfall Selector (2)**

- *Waterfall Selector #2 controls waterfall output.*

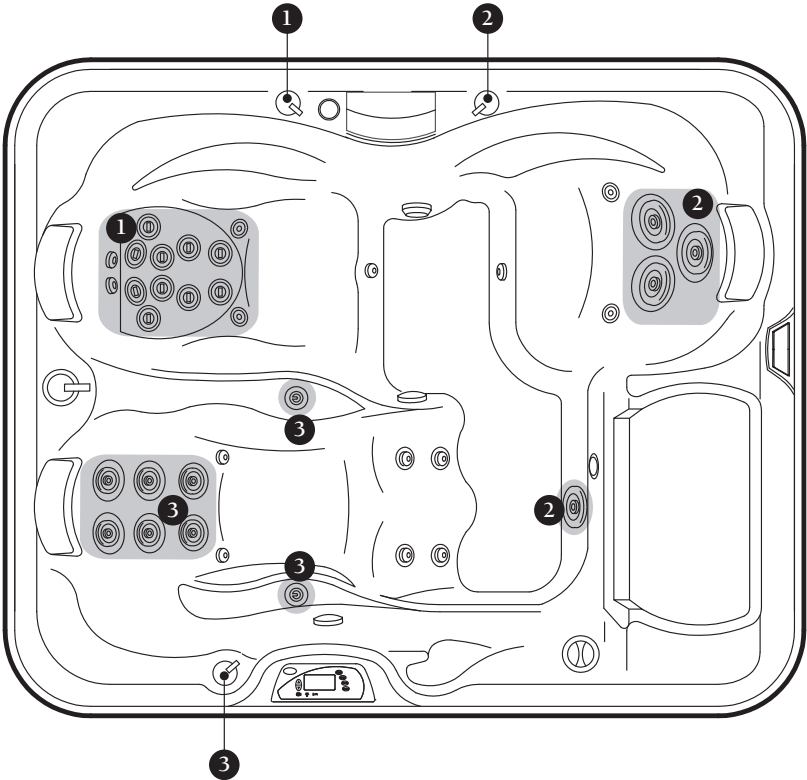
*Spa operation subject to change without notice.*



## 10.26 Capri Air Controls Diagram

### Air Control Operation

Rotate Air Controls 1-3 to add air to designated jet groups.





## 11.0 Heating Modes

The control system in your hot tub activates a programmable “standard” or “economy” mode which effects when the heater operates. Refer to Sections 11.1 and 11.2 below for additional information.


### 11.1 Standard Mode (Factory Default)

Standard mode is typically selected by customers in cold climates where heat up times are extended due to lower ambient temperatures. In this mode, water temperature is regulated by the set temperature which activates the heater automatically as needed.

### 11.2 Economy Mode

Economy mode is typically selected by customers in warm climates where heat up times are minimized due to higher ambient temperatures. In this mode, the water temperature is regulated by the set temperature only when a programmed filter cycle is running.

### 11.3 Selecting Standard or Economy Mode

Press the **(MODE)**  button to select either “Standard” or “Economy” mode. The control panel's indicator on the right side of the LCD changes to indicate which mode is selected. *Note: “Standard” is shown when Standard Mode is selected. No display is shown when economy mode is selected.*

### 11.4 Clean-Up “Blow-Out” Cycle

The clean-up cycle is once per day in both Standard and Economy modes at 12:00 (noon) for two minutes. This is not user programmable.

- Maxxus Models: Jets pump 3 and blower activate for approximately 45 seconds to circulate any water in the plumbing. Pump 3 shuts off, then pump 2 and the blower activate for approximately 45 seconds, then shut off. Finally, pump 1 activates and runs for approximately 30 seconds, then shuts off.
- Altamar/Cameo/Marin/Majesta/Optima Models: Jets pump 2 and blower activate for one minute to circulate any water in the plumbing. After 1 minute, pump 2 and blower shut off and jets pump 1 activates for 1 minute, then shuts off.
- Capri Models: The blower activates for one minute to circulate any water in the plumbing. After 1 minute, the blower shuts off and jets pump 1 activates for 1 minute, then shuts off.











## 12.0 Programming Instructions

### 12.1 Programming Filter/Circulation Pump (Standard Mode)

The Sentry control system allows you to easily adjust two separate aspects of filter/circulation pump operation:

1. The time of day (start time) the filter/circulation pump turns on.
2. The length of time (duration) the filter/circulation pump operates.

The factory default start time is 12:00am (midnight). The default duration is 24 hours. To make adjustments, press the **(CYCLE)**  button once to enter the filter/circulation pump programming mode. The LCD screen will display **“Circ”** At this time the system is ready to accept your changes:

- Press the **(SELECT)**  button once. The previously programmed start time appears on the LCD display.
- Press **(UP)**  or **(DOWN)**  buttons to adjust the start time in 30-minute increments.
- Press the **(SELECT)**  buttons to program duration.
- Press **(UP)**  or **(DOWN)**  buttons to program the duration time in 1 hour increments.
- Press **(DISPLAY)**  button to save changes and recall the main water temperature display. *Note: If no button is pressed within 30 seconds, all changes are recorded and the screen automatically returns to the standard water temperature display.*

*Note: When the standard mode is selected (Section 11.3), the filter/circulation pump automatically turns on for a heat call regardless of the pump’s programmed start time and duration.*


### 12.2 Programmable Heat Cycles (Economy Mode Only)

Your hot tub comes with four 30-minute filter cycles which activate the filter/circulation pump while in economy mode. These cycles are factory programmed to start at 6:00 AM, 12:00 (noon), 6:00 PM, and 12:00 (midnight). The control system allows you to easily adjust two separate aspects of each cycle: 1) the time of day at which it begins; 2) the duration of the cycle.

*Note: When “Economy” mode is selected (Section 11.3), the heater activates only during a programmed filter cycle period. When a Summer Logic condition is active (page 50), the filter/circulation pump will turn on for all programmed filter cycles.*












**Summer Logic:** In warm weather, the water temperature in the hot tub may exceed the set temperature. This condition may occur due to heat transference from the filter/circulation pump and jets pumps. If the water temperature is higher than 95°F (35°C) and rises two degrees above the set temperature, a “Summer Logic” condition occurs that deactivates the filter/circulation pump and ozonator (if equipped). This safety feature cannot be altered! The filter/circulation pump and ozonator will remain off until the water temperature cools to the set temperature (except between 9am-11am when the filter/circulation pump runs for it’s mandatory 2 hour cycle). *Note: Pressing the select button at this time will reactivate the circulation pump and waterfall feature for 1 hour.* To help prevent a “Summer Logic” condition, it may be necessary to reduce filter/circulation pump cycles run times in warm weather.

To make adjustments, first press the **(CYCLE)**  button to enter the filter cycle programming mode. The LCD screen will display the following in the upper right corner:



\*Note: Number will vary according to which filter cycle is being programmed.

This means the system is ready to accept you changes to the start time for cycle number one. Simultaneously, the large four-digit display in the center of the screen displays the currently programmed start time for that cycle. At this point, you have four options. You may:

1. Press **(UP)**  or **(DOWN)**  button to adjust the start time in increments of 30 minutes.
2. Press **(CYCLE)**  button to display and adjust each subsequent cycles start time. With each press, the currently programmed status will be shown in the large four digit display. To adjust any displayed value, simply press the **(UP)**  or **(DOWN)**  button.
3. Press **(SELECT)**  button to move down the menu from Start Time to Duration, with each press, the currently programmed duration will be shown in the large four-digit display. Press **(UP)**  or **(DOWN)**  button to adjust the duration in increments of 15 minutes.
4. Press **(DISPLAY)**  button to save changes and recall the main water temperature display. *Note: If no button is pressed within 30 seconds, all changes are recorded and the screen automatically returns to the standard water temperature display.*


















When a programmed filter/heating cycle activates, the LCD screen displays the following message:



\*Note: Number will vary according to which filter cycle is being programmed.









At any time, you may check the programming of any economy mode filter/heating cycle by first pressing **(CYCLE)**  button then moving through the menu by pressing either **(CYCLE)**  or **(SELECT)**  button. The programming is changed only by pressing **(UP)**  or **(DOWN)**  buttons during this process.

### 12.3 Adjusting Time of Day

The Sentry control system remembers the time of day even in the event of a prolonged power outage. However, it may occasionally be necessary to reset the time of day. For example: if you are not in the Pacific Time Zone you will want to reset the time for your own time zone. (The system will automatically adjust to and from daylight savings time.) To accomplish this, press **(DISPLAY)** , **(MODE)**  and **(DISPLAY)**  button within five seconds each. A number representing the hour will be displayed, followed by AM or PM. The hour will advance or decrease each time the **(UP)**  or **(DOWN)**  button is pressed within five seconds. Then, press the **(DISPLAY)**  button again to display minutes. Adjust minutes as necessary by pressing the **(UP)**  or **(DOWN)**  button. After 5 seconds, the display will return to normal and save your settings.

### 12.4 Main Control Panel Lock











To help prevent unauthorized use of your hot tub, the Sentry controls incorporate a unique panel locking system which disables the controls on the panel.

- To Lock The Main Control Panel: Press **(DISPLAY)** , **(MODE)**  and **(UP)**  buttons within five seconds each. A padlock symbol will appear on the LCD screen.  With the panel locked, all components are disabled from manual activation and the only settings that can be adjusted are the standard and economy filter/heating modes and time of day. All automatic hot tub functions will operate normally.
- To Unlock Main Control Panel: Press **(DISPLAY)** , **(MODE)**  and **(DOWN)**  buttons within five seconds. The "lock" symbol will disappear. All buttons are now active. 



## 12.5 Temperature Setting Lock

The hot tub's temperature setting can be locked to prevent unauthorized changes. When locked, all other hot tub buttons and functions operate normally.

- **To Lock Temperature Setting:** Press **(UP)**  or **(DOWN)**  button to display temperature setting, then immediately press the **(DISPLAY)** , **(MODE)** , and **(UP)**  buttons within five seconds each. A padlock symbol will appear on the screen.
- **To Unlock Temperature Setting:** Press **(UP)**  or **(DOWN)**  button to display temperature setting, then immediately press the **(DISPLAY)** , **(MODE)** , and **(DOWN)**  buttons within five seconds.







## 12.6 Programming the Change Filter Reminder


Your new hot tub is equipped with a programmable “Change Filter” reminder icon that flashes on the control panel display after a specified number of days. It is designed to remind you to inspect or replace the MicroClean Plus filter cartridge on a regular basis but does not affect hot tub operation in any way. Your hot tub's MicroClean Plus filter cartridge is designed as a disposable cartridge and should be replaced (thrown-out) every 6 months to ensure optimum water filtration. The “Change Filter” reminder icon must be reset at each filter inspection/replacement interval. It offers a selectable range from 10-120 days or can be disabled (turned off). We recommend an initial setting of 120 days (4 months) to remind you to check your MicroClean Plus cartridge after your first 4 months of operation. At this time, you can easily determine whether you need to change this interval by visually inspecting the filter cartridge. *Note: This reminder must be reset at each filter inspection/replacement interval. Refer to Section 13.1 for filter replacement instructions.*



### Programming Instructions

1. Press the **(CYCLE)**  button two times. The main display reads “FIL” indicating the “Change Filter” display program has been accessed.
2. Press **(SELECT)**  button once to display the currently programmed duration or to view days elapsed since last filter cleaning interval.
3. Press **(UP)**  or **(DOWN)**  button to change duration setting as follows: 0 - 10 - 20 - 30 - 40 - 50 - 60 - 70 - 80 - 90 - 100 - 110 - 120 - OFF. *Note: Selecting “0” forces the Change Filter reminder icon to stay on indefinitely.*

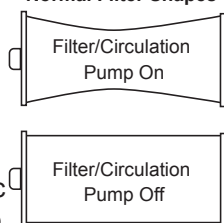


4. Press **(DISPLAY)**  button once to save changes and return to the standard water temperature display. *Note: If no button is pressed within 30 seconds, all changes are recorded and the screen automatically returns to the standard water temperature display.*

### 13.0 Hot Tub Maintenance

Proper and regular maintenance of your hot tub will help it retain its beauty and performance. Your authorized Sundance Spas dealer can supply you with all the information, supplies, and accessory products you will need to accomplish this. Your new hot tub is equipped with an advanced MicroClean Plus filter cartridge. This cartridge utilizes a dynamic flow design that allows it to compress in the center to form a hour-glass shape under normal operating conditions. *Note: The degree of filter compression will vary from hot tub to hot tub and is normal for the filter cartridge to straighten out when power to the hot tub is turned off.*

Normal Filter Shapes



**DANGER!** Risk of Injury. The suction fittings in this spa are sized to match the specific water flow created by the pump. If it is necessary to replace the suction fittings or the pump, be sure that the flow rates are compatible. Because of the risk of injury,

- Never operate or use the spa if the filter, filter lid, or skimmer assembly are broken or any part of the skimmer assembly is missing. Please contact your dealer or nearest service center for service.
- Never replace a suction fitting with one rated less than the flow rate marked on the original suction fitting.

#### 13.1 Replacing the Filter Cartridge



A programmable “Change Filter” reminder icon flashes on the control panel display after a specified number days to remind you to inspect and/or replace the MicroClean Plus filter cartridge. This reminder must be reset at each filter inspection/replacement interval. Refer to Section 12.7 (page 52) for additional information and programming details.



Your Sundance hot tub is equipped with a high-efficiency MicroClean Plus filter cartridge under the filter lid (Figures G through M, pages 22-28). Debris is filtered by the filter/circulation pump drawing water through this cartridge 24 hours a day, 7 days a week (unless programmed otherwise.) To ensure optimum performance, replace this cartridge every 6 months or as needed. This filter cannot be cleaned and reused and MUST be thrown out after use.

All models include a suction cover filter (#6540-213) located directly under the MicroClean Plus filter cartridge that prevents debris from entering the hot tub plumbing when jets pump 1 is running. This filter should be cleaned every 2 months.



### **ALWAYS TURN POWER TO THE HOT TUB OFF BEFORE REPLACING THE MICROCLEAR PLUS FILTER CARTRIDGE!**

Follow the procedures below when the filter needs replacing.

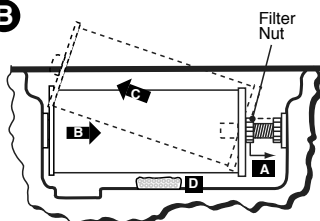
**A**



**TURN POWER TO HOT TUB OFF!**

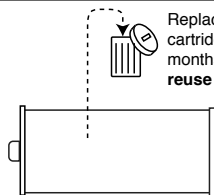


**B**



Loosen filter nut (A) to provide clearance, then remove used MicroClean Plus filter cartridge (steps B-C). Remove suction fitting filter (D) and clean with mild liquid soap solution and warm water, then reinstall over suction fitting.

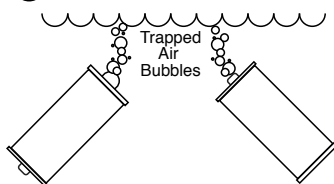
**C**



Replace MicroClean Plus cartridge every 6 months, **DO NOT reuse for any reason!**

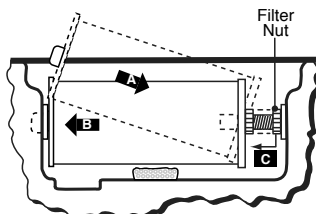
Replace (throw-away) the MicroClean Plus filter cartridge every 6 months, or as needed! **DO NOT reuse this cartridge for any reason!**

**D**



Submerge new filter cartridge in spa and tilt each end upward to remove most of the air bubbles trapped inside the filter.

**E**



1. Install new filter cartridge, then tighten filter nut until it just touches filter face. **DO NOT OVERTIGHTEN!**
2. Turn power to hot tub back on.



Replacement MicroClean Plus filter cartridges may be purchased from your Sundance Spas dealer. An optional pleated filter cartridge is also available from your Sundance Spas dealer (#6540-488). This filter can be cleaned and reused for up to two years but does not maintain the same water quality and clarity as the standard MicroClean Plus cartridge.

### 13.2 Draining And Refilling

About every 3 to 6 months, you should replace the hot tub's water. The frequency depends on a number of variables including the amount of use, attention paid to water quality maintenance, etc. You will know it is time for a change when you cannot control sudsing and/or you can no longer get the normal feel or sparkle to the water even though the key water balance measurements are all within the proper parameters.



**CAUTION! READ THIS BEFORE DRAINING:** To prevent damage to the hot tub's components, turn off power to the hot tub at the circuit breaker before draining it. Do not turn the power back on until your hot tub has been refilled. There are certain precautions to keep in mind when draining your hot tub. If it is extremely cold, and the hot tub is outdoors, freezing could occur in the lines or the equipment (see "Winterizing", page 57). On the other hand, if it is hot outdoors, do not leave the hot tub's surface exposed to direct sunlight for long periods.

#### Draining Procedures:

1. Turn off power to hot tub at breaker.
2. Locate the 3" gray drain valve cap on side of the hot tub cabinet. Unscrew drain valve cap to expose the underlying male garden hose fitting (figure A-B).
3. Attach female garden hose end to drain fitting and route opposite end of garden hose away from hot tub (figure B).
4. Pull outward on garden hose end at drain connection (approx. 3/8") to open drain valve and release water from hot tub (figure C). Water drains at approximately 3 gallons per minute.
5. After hot tub has drained, close drain valve by pushing inward on garden hose end at drain connection until you feel it bottom out. Remove garden hose and install gray drain cap before refilling hot tub. *Note: The gray drain cap cannot be installed until the drain valve is closed. Refer to "Hot Tub Fill up Procedure" (page 15) for recommended filling instructions.*

Figure A



Figure B

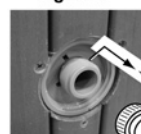
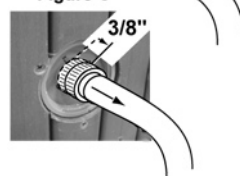


Figure C





### 13.3 Cleaning The Hot Tub Interior

To preserve the sheen of your hot tub's surface, it is crucial that you avoid using abrasive cleaners or cleaners which have adverse chemical effect on the surface. If you are not certain as to the suitability of a particular cleanser, consult your authorized Sundance Spas dealer. Regardless of the cleanser used, use extreme care to assure that no soap residue is left on the surface. This could cause severe sudsing when the hot tub is refilled.

### 13.4 Pillow Care

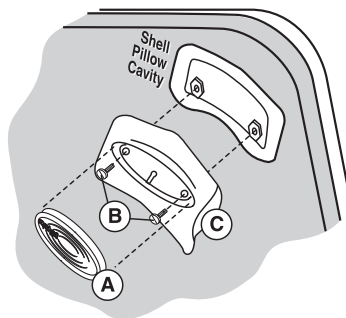
Remove and clean the headrest pillows as needed with soapy water using a cloth or soft-bristle brush. To maintain water resistance and luster, apply a quality vinyl conditioner once a month.



**IMPORTANT:** Never attempt to remove the pillows by pulling on them! The pillows utilize a bolt-on design that prohibits removal without tools.

To remove pillows:

1. Grasp center pillow insert (A) with finger tips and gently pry outward from pillow base (C).
2. Use a standard screwdriver to loosen and remove mounting bolts (B) from pillow base.
3. Assemble in reverse order after cleaning. **DO NOT** overtighten pillow mounting bolts!



### 13.5 Maintaining the Synthetic or TerraStone Cabinet

The Synthetic or TerraStone cabinet require little or no maintenance of any kind. To clean, wipe cabinet with a clean towel and mild detergent soap solution.



**CAUTION:** Never spray cabinet with a high pressure garden hose for any reason since this action may induce an electrical short in the hot tub's electrical equipment.



### 13.6 Maintaining The Cover

Using the Sundance insulating hot tub cover anytime the hot tub is not in use will significantly reduce your operating costs, heat-up time, and maintenance requirements. To prolong the life of the cover, handle it with care and clean it regularly using mild soap and water. Periodic treatments with a special conditioner developed for Sundance hot tub covers will help protect against deterioration caused by U.V. rays from the sun. Never allow anyone to stand or sit on the cover, and avoid dragging it across rough surfaces.

### 13.7 Winterizing

Your Sundance hot tub is designed to automatically protect itself against freezing when operating properly. During periods of severe freezing temperatures, you should check periodically to be certain that the electrical supply to the hot tub has not been interrupted. In extreme, bitter cold weather (less than  $-20^{\circ}\text{F}$ ) verify standard mode is selected (Section 11.3, page 48) to protect the hot tub from freezing.

If you do not intend to use your hot tub, or if there is a prolonged power outage during periods of severe freezing temperatures, it is important that all water be removed from the hot tub and equipment to protect against damage from freezing.

For expert winterization of your hot tub, contact your authorized Sundance Spas dealer. In emergency situations, damage can be minimized by taking the following steps:



**CAUTION: Turn off power to hot tub.**

1. Follow the directions on page 55 for draining the hot tub.
2. As the water level drops below the seats, use whatever means necessary to get the water out of the recessed seating areas and into the footwell.
3. When the water level ceases to drop, use whatever means available to remove any remaining water from the footwell.
4. Remove the equipment-side cabinet panels and locate the drain plugs in the front of each pump (Figures A and B, page 11). Remove these plugs to allow the water to drain out of the pumps and heater. *(Note: Approximately 1 to 2 gallons will be released during this procedure.) Use a wet/dry vacuum or other means to keep this from flooding the equipment compartment. Replace the drain plugs.)*



5. Loosen hose clamp at bottom of heater (Figures A and B, page 11) and pull hose off of heater fitting (twist the hose back and forth while pulling downward). Tip hose down and allow to drain, then reinstall hose and clamp.
6. Re-install cabinet side panels and cover hot tub so that no moisture can enter into it. Consult your Sundance Spas dealer if you have any questions regarding winter use or winterizing.

### **13.8 Restarting Your Hot Tub in Cold Weather**

If you want to start up your hot tub after it has sat empty for a time in freezing temperatures, be aware that the water remaining in certain sections of the piping may still be frozen. This situation will block water flow preventing the hot tub from operating properly and possibly damaging the equipment. We recommend you consult your dealer for guidance before attempting to restart your hot tub under these conditions.

## **14.0 Water Quality Maintenance**

Maintaining the quality of the water within specified limits will serve to enhance your enjoyment and prolong the life of the hot tub's equipment. It is a fairly simple task, but it requires regular attention because the water chemistry involved is a balance of several factors. There is no simple formula, and there is no avoiding it. Procrastination in regard to water maintenance will result in poor and potentially unhealthful conditions for soaking and even damage to your hot tub investment. For specific guidance on maintaining water quality, consult your Authorized Sundance Spas dealer who can recommend appropriate chemical products for sanitizing and maintaining your hot tub.



**CAUTION:** Never store hot tub chemicals inside the hot tub's equipment bay.

### **14.1 pH Control**

pH is a measure of relative acidity or alkalinity of water and is measured on a scale of 0 to 14. The midpoint of 7 is said to be neutral, above which is alkaline and below which is acidic. In hot tub water, it is very important to maintain a slightly alkaline condition of 7.4 to 7.6 pH. Problems become proportionately severe the further outside of this range the water





gets. A low pH will be corrosive to metals in the hot tub equipment. A high pH will cause minerals to deposit on the interior surface (scaling). In addition, the ability of the sanitation agents to keep the hot tub clean is severely affected as the pH moves beyond the ideal range. That is why almost all hot tub water test kits contain a measure for pH as well as sanitizer.

## 14.2 Sanitizing

To destroy bacteria and organic compounds in the hot tub water, a sanitizer must be used regularly. Your Sundance hot tub is equipped with the Brominator™, a special compartment built into the floating skimmer gate to hold bromine tablets. By regulating the number of bromine tablets in the Brominator™ you can control the amount of bromine which is actively working in your hot tub water. A bromine residual of 2.0-4.0 ppm is generally considered desirable. A two-part bromine system or granular chlorine (dichlor) are also acceptable sanitizers.

**IMPORTANT:** Do not use chlorine tablets (trichlor) in your hot tub. This chemical can have an extremely corrosive effect on certain materials in the hot tub. Damage caused by use of this chemical, or improper use of any chemicals, is not covered under the hot tub's warranty.

## 14.3 Other Additives

Many other additives are available for your hot tub. Some are necessary to compensate for out-of-balance water, some aid in cosmetic water treatment and others simply alter the feel or smell of the water. Your Authorized Sundance Spas dealer can advise you on the use of these additives.

## 14.4 Ozone Water Maintenance System

This system is optional on North American models and standard equipment on export 50Hz spa models. If your spa is equipped with the Sundance CD Ozone water purification system you will find that your water stays fresh and clear with significantly less chemical sanitizer usage. You will also probably be able to go longer between complete spa draining's.



## 14.5 Handrail Maintenance

The handrails in your Sundance hot tub are manufactured from a high quality 316 stainless steel alloy. Many people are familiar with the term “stainless steel” and are surprised to learn that it does indeed rust and corrode in the presence of chloride salts, free chlorine, or sulfide gases. The bad news is the environments that produce these elements are ocean spray, salted highways, chemical treatments added to swimming pools and hot tubs, and ground water in numerous coastal areas. The good news is with proper care, your hot tub’s handrails can maintain their original finish.

### If your stainless handrails shows signs of rusting you should:

- Wash with fresh water (a good detergent won’t hurt).
- Clean with a good car chrome polish.
- Wax with an automotive or fiberglass wax.

### You should never:

- Clean with chlorinated cleaners or scouring powders.
- Use sand paper, “Scotch Brite”, Brillo pads, or similar abrasive products.
- Clean with muratic or hydrochloric acids. Vinegar is ok, but it won’t do much to remove rust.

## 15.0 Troubleshooting - Display Messages

There are a number of unique functions designed into your Sundance hot tub to protect it from damage and/or to aid in troubleshooting. Following is a listing of all the possible messages along with their meanings:

### MESSAGE

**OH**

### MEANING

Overheat Protection (Heater is deactivated, filter/circulation pump is activated). Water temperature is above acceptable limits. Do not enter the water! Remove hot tub cover to speed cooling. See “Water is too hot” (page 61). If condition persists, contact your Sundance Spas dealer or qualified service technician.

**COOL**

If the hot tub water is more than 20°F cooler than the temperature setpoint, jets pump #1 and heater will automatically activate to provide freeze protection. The hot tub will stay in this mode until the water temperature reaches 15 degrees below the set temperature then turns off. No corrective action is necessary.



**FLO\***

FLOW SWITCH (Heater is deactivated. The filter/circulation may also be deactivated). Proper flow of water is inhibited or a flow switch has malfunctioned. Check for proper water level and for clogged filter (pages 53-54). Contact your Sundance Spas dealer or qualified service technician.

*\* Note: This message can also appear if the pump has not regained prime after the hot tub has been drained and refilled. If you suspect that this is the case, see the instructions on page 61 under "pump does not operate and icon does."*

**Hold**

Panel buttons have been pressed too many times in a short period of time. Because this could cause excessive wear on equipment components, panel buttons are temporarily deactivated. Panel buttons will automatically re-activate if no buttons are pressed for 30 seconds.

**HOT**

Circuit board temperature has exceeded acceptable limit. This message will disappear when the circuit board temperature drops below acceptable limit. If condition persists, provide shade for the side with the hot tub equipment.

**ICE**

**FREEZE PROTECTION**  
A potential freeze condition has been detected. No action is required. Jets pump(s) operate until the hot tub is out of danger. *Note: This error commonly occurs when the hot tub is first filled because tap water is often very cold.*

**PaL**

Communication between the control panel and/or remote control panel and circuit board is faulty. Contact your Sundance Spas dealer or qualified service technician.

-----

**"WATCHDOG"** (hot tub is deactivated)  
A problem has been detected which could cause damage to the hot tub or its components. Contact your Sundance Spas dealer or qualified service technician.



**Sn1**

OPEN SENSOR (heater disabled) or SHORTED SENSOR (hot tub is deactivated)

The high-limit temperature sensor is non-functional. This must be repaired only by an Sundance Spas dealer or qualified service technician.

**Sn3**

OPEN or SHORTED SENSOR (heater disabled).

The main temperature sensor is non-functional. This must be repaired only by an Sundance Spas dealer or qualified service technician.

**FL02  
1CE2**

CLOSED or SHORTED FLOW SWITCH ON SYSTEM STARTUP (system disabled) Flow switch is non-functional. This must be repaired only by an authorized dealer or qualified service technician.

## 16.0 Troubleshooting - Procedures

In the unlikely event your hot tub is not working the way you believe it should, please first review all the installation and operating instructions in this manual and check the message on the panel display; second, if you are still not satisfied it is working properly, please follow the appropriate troubleshooting instructions.

### PROBLEM

### PROCEDURE

None of the components operate (i.e. pump, blower, light)

Check the control panel lights.

1. If there are letters or symbols displayed on the screen, refer to the previous section to determine meaning and action required.
2. If nothing appears on the screen:
  - a. Check the household circuit breaker.
  - b. Contact you Sundance Spas dealer or qualified service technician.

Pump does not operate and icon does

Depress JETS button.

1. If no sound is detected or if a buzzing sound is detected, turn off power to the spa and contact your authorized dealer or qualified service technician.
2. If motor operates, but no water flows to jets:
  - a. Pump may not be properly primed. See instructions below.
  - b. Contact you Sundance Spas dealer or qualified service technician.



### **Pump Priming Instructions:**

This method must be used for the jets pumps because these pumps are not connected to the main filter system in any way.

1. Turn off the power to the spa.
2. Remove the handle from the massage selector supplied by the pump you are priming.
3. Loosen the massage selector's cap slightly (counterclockwise), listening for the air to seep out.
4. Tighten the cap finger tight, replace the handle, and turn the spa's power back on.



**CAUTION:** If freezing conditions exist and pump is not operational, take measures to protect the system from freeze damage. See Section titled "Winterizing", page 57.

### **PROBLEM**

Poor jet action  
(See figures G-M,  
pages 22-28)

Water is too hot

No heat

### **PROCEDURE**

1. Make certain the jets pump is turned on.
2. Check position of massage selectors.
3. Open air control for selected jet system.
4. Check for adequate water level.
5. Check for dirty filter (pages 53-54).

1. Reduce thermostat setting (page 16).
2. Switch hot tub to "Economy" mode to turn heater on only during programmed filter cycles (page 48).

1. Check thermostat setting.
2. Keep the cover in place while heating.
3. If "heater on" indicator is lit (page 21) but no temperature rise is experienced after a reasonable period of time, contact your Sundance Spas dealer or qualified service technician.



## PROBLEM

Filter/circulation pump off

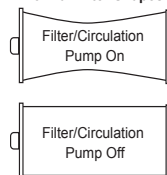
## PROCEDURE

1. Verify filter/circulation pump is programmed to run 24 hours a day (page 49).
2. Filter/circulation pump cycle canceled by power interruption. Wait 24 hours for hot tub to reset or press select button for manual activation.
3. Hot tub water is warmer than 95°F (35°C) and two degrees warmer than the set temperature. The “Summer Logic” safety feature has activated. See note on page 50 for details.

Filter cartridge looks compressed

Your new spa is equipped with an advanced MicroClean Plus filter cartridge. This cartridge utilizes a dynamic flow design which allows it to compress in the center to form a hour glass shape under normal operating conditions. *Note: The degree of filter compression will vary from spa to spa and it is normal for the filter cartridge to straighten out when power to the spa is turned off.*

Normal Filter Shapes



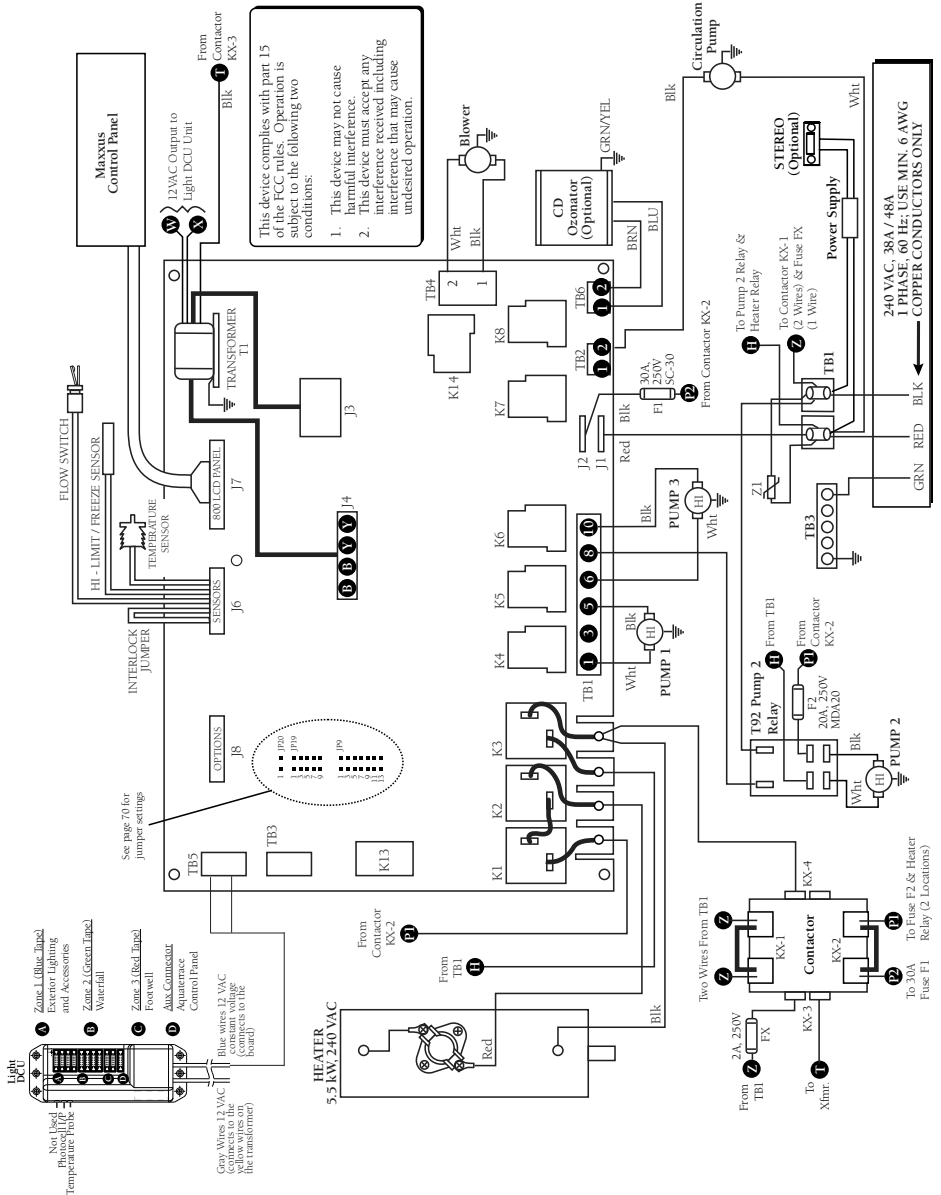
Should checking the above steps fail to correct the problem, please call your authorized dealer so that he may arrange service.

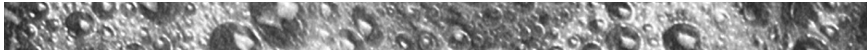
Sundance builds the best hot tubs in the industry. Nonetheless, we are always striving to improve the quality and features of our products. Your input as a Sundance hot tub owner is a cherished part of this process. If you have any comments or suggestions, or if you wish to be informed on any new products for your hot tub, please write to us.

**CONGRATULATIONS** on your good taste and welcome to the happiest and most relaxed family in the world!



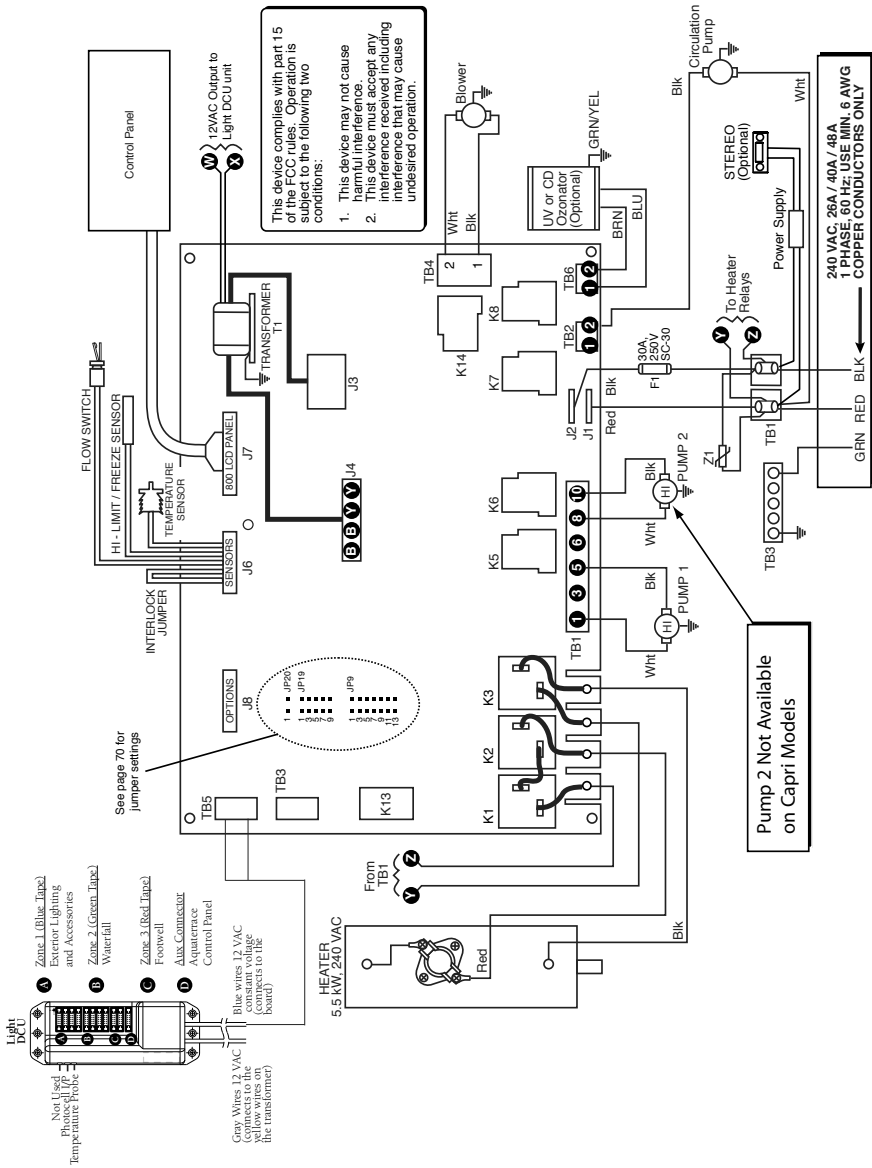
# 17.0 North American 60Hz Maxxus Electrical Wiring Diagram





# 18.0 North American 60Hz Altamar/Cameo/Capri/Majesta/ Optima/Marin Electrical Wiring Diagram

Board Option A (See page 67 for Board Option B)

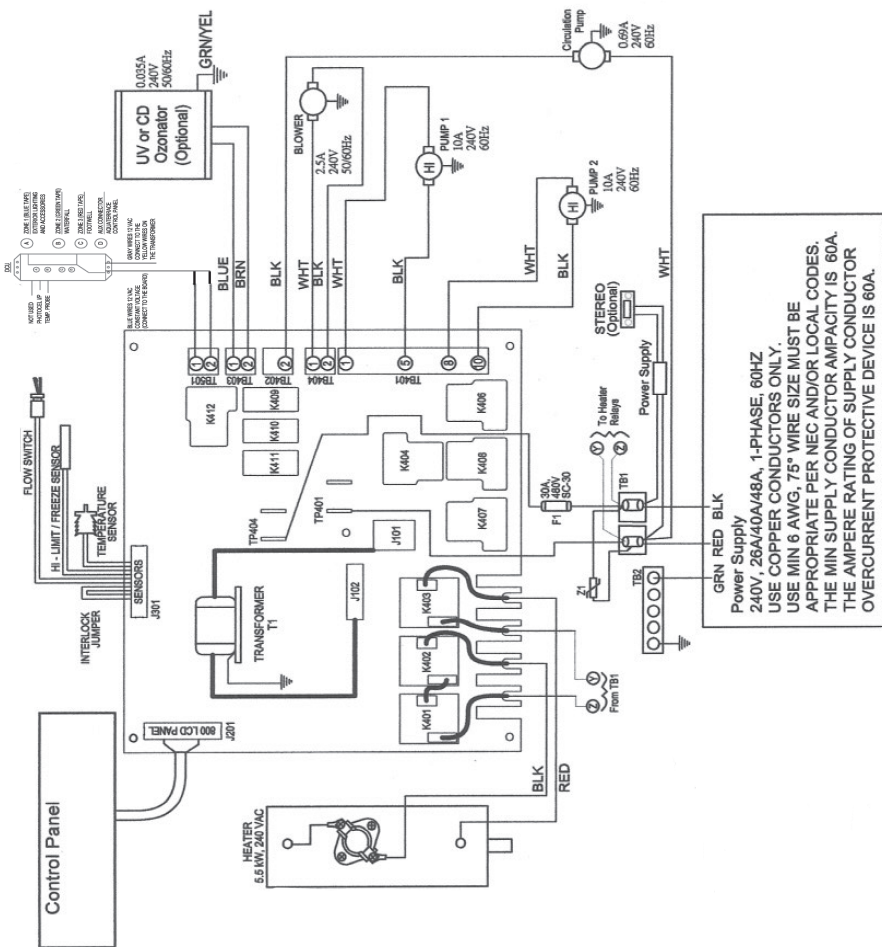






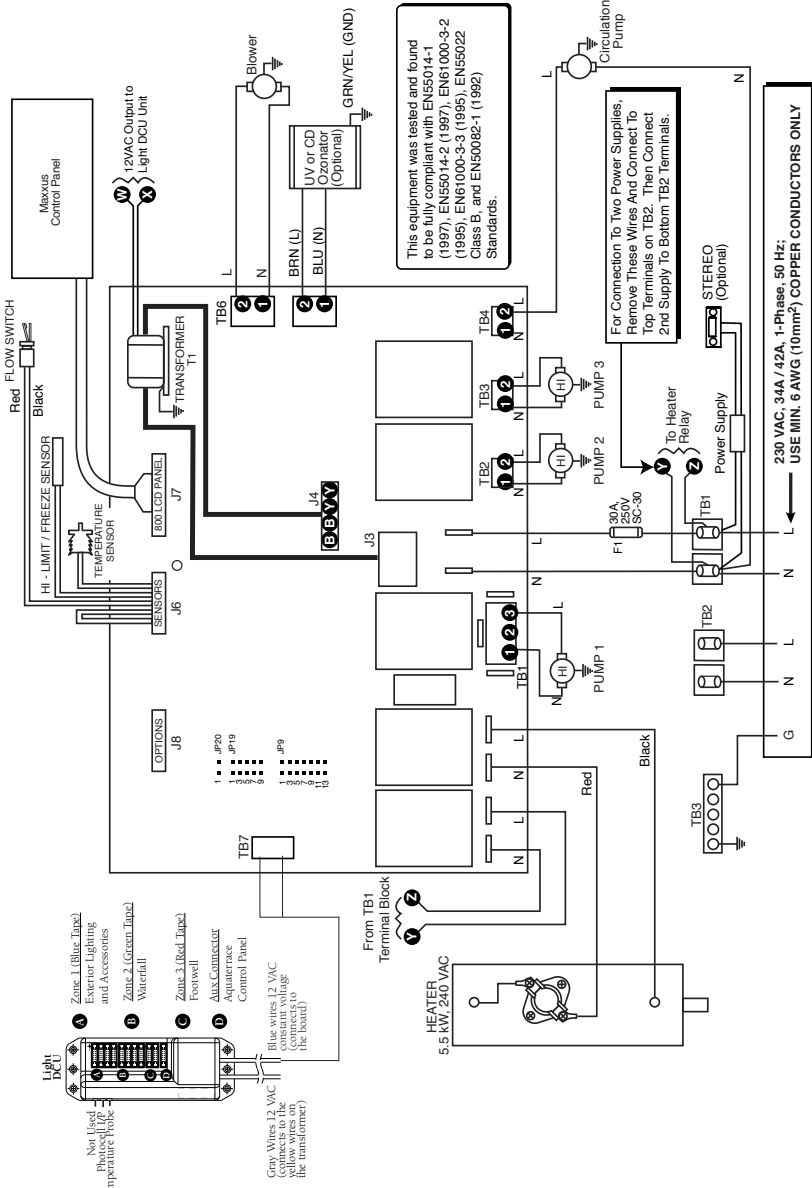
# 19.0 North American 60Hz Cameo/Optima Electrical Wiring Diagram

Board Option B (See page 66 for Board Option A and jumper pin settings)



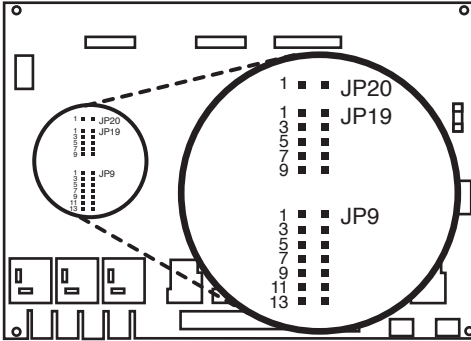


## 20.0 Export 50Hz Maxxus Electrical Wiring Diagram





## 21.0 Circuit Board Pin Assignments



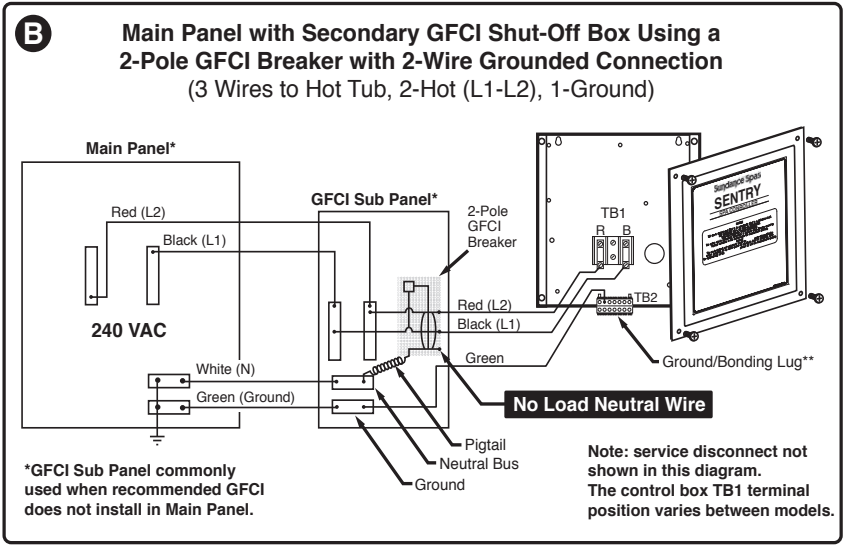
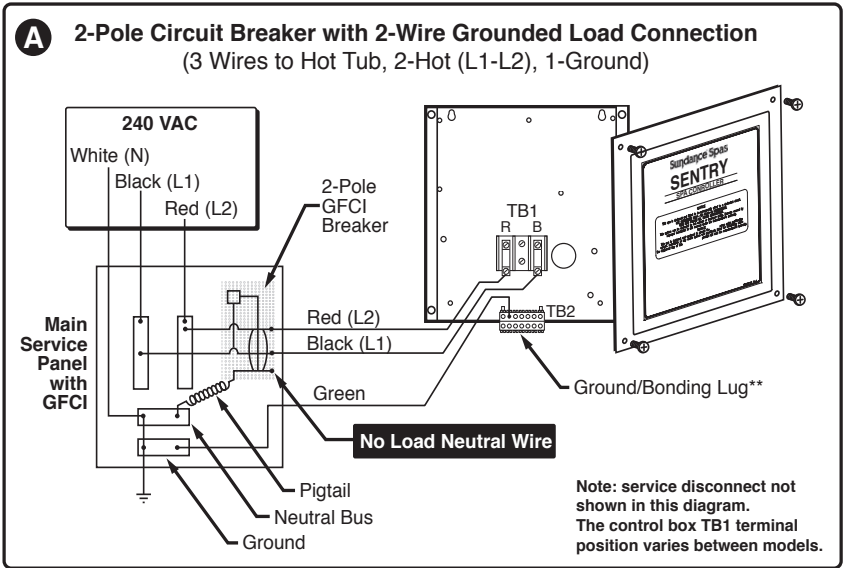
**CAUTION:** Always turn off power to spa before making circuit board changes.

Refer to pages 13-14 for additional jumper configuration details.

JP20-1	Not Used
JP19-1	On = °C    Off = °F
JP19-3	Not Used
JP19-5	Enables the logic for the Multi Color LED Light
JP19-7	Not used
JP19-9	Not Used
JP9-1	Not Used
JP9-3	Not Used
JP9-5	Not used
JP9-7	On = 60A Logic    Off = 40/50A Logic (See Section 6.0 pages 13-14 for logic details)
JP9-9	On = 2 or 3 Pump Logic    Off = 1 Pump Logic
JP9-11	On = 40A Logic (See pages 13-14 for logic details)
JP9-13	Not used



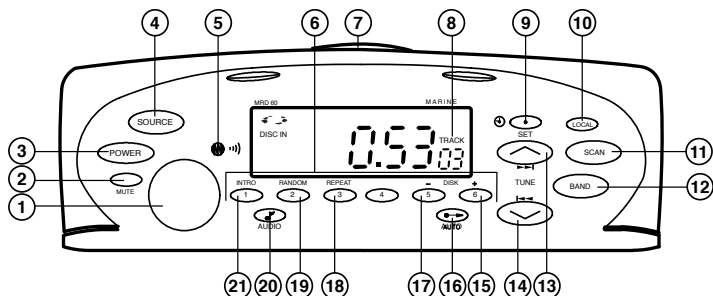
## 22.0 Typical Hot Tub Wiring Diagrams A-B (North American 60 Hz Models Only)





## 23.0 Optional SunSound™ Stereo Receiver Features

### 23.1 SunSound Stereo Receiver Button Controls



- |   |                    |
|---|--------------------|
| 1. Volume Up/Down (VOL)                             | 11. Scan           |
| 2. Mute   | 12. Band           |
| 3. Power On/Off                                     | 13. Tune/Seek Up   |
| 4. Source   | 14. Tune/Seek Down |
| 5. Infrared Receiver for<br>Wireless Remote Control | 15. Disc +         |
| 6. Preset Buttons 1 to 6                            | 16. Auto           |
| 7. Front Panel Release Button                       | 17. Disc -         |
| 8. Display  | 18. Repeat (CD)    |
| 9. Clock Set  | 19. Random (CD)    |
| 10. Local   | 20. Audio          |
|   | 21. Intro (CD)     |

### 23.2 SunSound Stereo Receiver General Controls

#### A. Power On and Off

Make sure hot tub power is turned on, then press power button (3) once to turn on. Press a second time to turn off.

#### B. Adjusting Volume

Rotate volume knob (1) to increase or decrease volume. Current volume setting is briefly indicated on the display (0 to 31).

#### C. Mute

Press mute button (2) once to mute audio output ("Mute" flashes on display). To restore audio output, press mute button a second time, or rotate volume knob.

#### D. Program Selection

Press source button (4) to cycle through available program sources as follows: Tuner - CD - Tuner. If a source is unavailable (e.g. no CD inserted), that source will not appear on the display.



### **E. Adjusting Bass Level**

Press audio button (20) until display reads “BAS.” Rotate volume knob to desired setting. A display of “C O” indicates center, -2 to -12 indicates bass cut, and +2 to +12 indicates bass boost. *Note: Unit returns to volume mode if volume control is not rotated for 3 seconds.*

### **F. Adjusting Treble Level**

Press audio button (20) until display reads “TRE.” Rotate volume knob to desired setting. A display of “C O” indicates center, -2 to -12 indicates treble cut, +2 to +12 indicates treble boost. *Note: Unit returns to volume mode if volume control is not rotated for 3 seconds.*

### **G. Adjusting Balance**

Press the audio button (20) until display indicates “BAL.” Rotate volume knob to desired setting. A display of “C O” indicates center, L1 to 15 indicates left balance, R1 to 15 indicates right balance. *Note: Unit returns to volume mode if volume control is not rotated for 3 seconds.*

## **22.3 SunSound Stereo Receiver Operation**

### **A. Adjust Fader**

Press audio button (20) until display reads “FAD.” Rotate volume knob to desired setting. A display of “C O” indicates center, “R” 1 to 15 indicates rear fade, “F” 1 to 15 indicates front fade. *Note: Unit returns to volume mode if volume control is not rotated for 3 seconds.*

### **B. Display Clock**

Press set button (9) to toggle display between clock and radio modes. When clock mode is selected, the current time displays whenever the unit is left undisturbed.

### **C. Set Clock**

Press and hold set button (9) for 2 seconds until first time digit flashes on display. Use tune/seek-up button (13) or tune/seek-down button (14) to set hour, noting AM/PM indicator at left. Briefly press set button a second time to select minutes display. Press set button a third time to complete procedure. Unit remains in clock mode and displays time after 3 seconds. *Note: When power to hot tub is shut off for any reason, the clock will be reset to 12:00 AM.*

### **D. Open/Close Front Panel**

Place thumb on front panel release button (7) with forefinger below front overhang. Press firmly on release button, then flip panel open by pull-



ing outward at top edge. To close panel, flip panel up and press firmly until you hear an audible click. Keep the front panel closed at all times to prevent water intrusion, except when changing discs.



**CAUTION:** never insert wet discs into unit or CD player will be damaged!

### E. Radio Operation

Press source button (4) to select radio mode. Station frequency is indicated on display.

- To Select Band: press band button (12) to toggle through radio modes as follows: FM1 - FM2 - FM3 - AM1 - AM2 - FM1. Each radio band stores up to 6 independent presets, for a total of 18 FM and 12 AM presets.
- To Program Presets: tune in desired radio station, then press and hold desired preset button for at least 2 seconds. "PX", where X=preset number, appears at bottom right of the display. *Note: When power to hot tub is shut off for any reason, all station presets are reset.*

### F. Automatically Setting Station Presets

To automatically set station presets to their next higher stations, press the preset button (1 to 6) from which to start programming, then press and hold the auto button (16) for at least 2 seconds. The current station preset and additional preset memories up to P6 will be reprogrammed with their next higher tunable stations. When the auto preset cycle is complete, the unit will remain in preset scan mode and continue scanning for presets until the auto button (16) is pressed. To select only the strongest stations, press the local button (10). All 18 FM and 12 AM presets can be set sequentially by selecting the next band and continuing the operation during auto programming.

### G. Seek/Manual Tune

Press tune/seek-up button (13) once to automatically tune the next higher station. Press tune/seek-down button (14) once to automatically tune the next lower station. To manually tune to a specific station frequency, press and hold either tune/seek button for at least 2 seconds. Holding either button down will increase or decrease the displayed frequency manually. When the desired frequency is reached, release the button. The unit remains in manual tune mode for 3 seconds after either button is released so you can fine tune the station frequency with additional button presses. *Note: After 3 seconds, seek mode is re-enabled.*



## H. Scan Functions

Select any AM or FM band and press scan button (11) to listen to a few seconds of each radio station. The display will flash and the radio will automatically scan to the next higher station, play that station for a few seconds, then scan to the next higher station. To stop scanning and continue listening to the current station, press scan button a second time. *Note: The radio remains in scan mode until the scan button is pressed a second time or one of the tune buttons is pressed.*

## I. Preset Scan Function

Press the auto button (16) once to enter scan mode. The next higher preset station will be selected and be played for 3 seconds while the preset number on the display flashes. If you wish to remain on this station, press the auto button (16) a second time. *Note: Preset scanning continues unless you press the auto button (16) or either preset button (P1-P6) to cancel.*

## J. Local/Distance Function

Press the local button (10) to toggle between local and distant station mode. When "LOCAL" is displayed, only the strongest stations will be selected during seek or scan. *Note: In the default mode (no LOCAL display), all usable stations will be selected during seek or scan.*

## K. Changing Tuner Frequency from US to Europe

Your unit is factory set to US tuning frequency steps. To switch to Europe tuning steps, use the switch on the bottom of the unit. With the unit disconnected from the power source, use a screwdriver to slide the switch to the desired position. *Note: Power must be removed from the radio, or the reset switch must be pressed before the new frequency mode is activated.*

## 23.4 SunSound Stereo Receiver Troubleshooting

### A. Unit will not turn-on

Make sure hot tub power is turned on, then check both harness fuses on back of unit making sure they are the proper ratings:

- Yellow memory B+ line (1A fuse); Red ACC line (10A fuse).
- With hot tub power off, use a thin rod to press the reset button located under the front panel.

### B. Fogged CDs and Lens

This condition may occur when it's cold. Wipe fogged CDs with a soft cloth. Fogged optical components inside the unit will return to normal operation after an hour in a heated environment.





## 23.5 SunSound Stereo Receiver CD Player Operation

### A. Insert, Play, and Eject a CD

Open the front panel and insert a CD into the slot with the CD label facing up. The CD will be drawn inside by the motorized mechanism. Close the front panel. The “DISC IN” symbol on the display indicates that a CD is in the drive.

- To play CD: press the source button (4) to change to CD mode. The CD will play. The display shows the current track and play time, and will animate a 3-D rotating disc while the CD is playing. *Note: If CD play time is not shown, press clock set button (9) once.*
- To remove CD: open the front panel and press the CD eject button located under the front panel. Remove CD from drive and close front panel.



**CAUTION:** listen for an audible click to ensure the front panel is closed to prevent water intrusion that could damage your unit.

### B. Changing CD Tracks and Music Seek

To advance to the next track, press the tune/seek-up button (13) once and the track counter will increase one track. When the final track is reached on the CD, play will resume on track #1.

- To fast forward through tracks: press and hold the tune/seek-up button (13) until the track counter displays the desired track, then release the button.
- To return to the beginning of the current track: press the tune/seek down button (14). Pressing it a second time within 1 second will skip back to the previous track.
- To rewind the current track: press and hold the tune/seek-down button (14). The track will quickly rewind until you release the button.

### C. Intro Scan, Random, Repeat

- Intro Scan Mode: press intro button (21) to enter intro scan mode. The left side of the display reads “SCN” and the first 10 seconds of each CD track will play continuously until you press the intro button a second time, or press either tune/seek-up button (13) or tune/seek-down button (14).
- Random Mode: press the random button (19) to play the CD tracks in random order. The left side of the display reads “RDM” when random mode is enabled.
- Repeat Mode: press the repeat button (18) to repeat the current CD track continuously. The left side of the display reads “RPT” when repeat mode is enabled.



### 23.6 Stereo Receiver Specifications

FM usable sensitivity . . . . .	10 dBf
FM 50 dB quieting sensitivity . . . . .	15 dBf
FM alternate channel selectivity . . . . .	90 dB
FM stereo separation @ 1kHz. . . . .	.60 dBf
AM usable sensitivity . . . . .	30 $\mu$ V

#### CD Player

Sampling frequency (8X oversampling) . . . . .	44.1 kHz
Channel separation @ 1 kHz. . . . .	80 db
Signal-to-noise ratio . . . . .	90 dBA
Frequency-to-noise response @ $\pm$ 1 dB . . . . .	20-20 kHz

#### Audio

Maximum power output (45 watts x 4 channel) . . . . .	180 W
Continuous power, 20-20 kHz, 4 ohms, 1% THD . . . . .	18 x 4
Bass boost/cut . . . . .	10/100 $\pm$ dB/Hz
Treble boost/cut . . . . .	10/10+/-dB/kHz

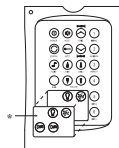
#### General

Nominal power supply . . . . .	14.4 VDC
Allowable power supply . . . . .	10.8-15.6 VDC
Current consumption . . . . .	<10 Amp
Speaker impedance . . . . .	4-8 Ohms



















## 23.7 Standard Wireless Remote Control Functions

This remote is included with the optional SunSound Stereo system. The jets, lights and air blower buttons on this remote require an optional ISC adapter kit for operation, #20230-001\*. Contact your Sundance Spas dealer for details.







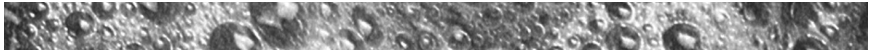
- Usable range 15' (5m)
- Never leave the remote under the spa cover for any reason
- Battery Replacement: Use Coin Type, CR2025 or equivalent

Wireless Remote Control Command Summary			
Button	Operation	Button	Operation
 POWER	Power Button: On/Off.	 INTRO	Intro/Station 1 Preset Button: <ul style="list-style-type: none"> <li>• In CD mode: provides you a 5 second preview of each track.</li> <li>• In radio mode: plays preset station 1 or press and hold for 3 seconds to set station 1.</li> </ul>
 MUTE	Mute Button: On/Off.	 RANDOM	Random/Station 2 Preset Button: <ul style="list-style-type: none"> <li>• In CD mode: plays CD tracks in a random mode.</li> <li>• In radio mode: plays preset station 2 or press and hold to set station 2.</li> </ul>
 SOURCE	Source Button: Selects Radio, CD or iPod/MP3 Player function.	 REPEAT	Repeat/Station 3 Preset Button: <ul style="list-style-type: none"> <li>• In CD mode: repeats same CD track until the feature is deactivated.</li> <li>• In radio mode: plays preset station 3 or press and hold to set station 3.</li> </ul>
 AUTO	Auto Button: Scans through preset radio stations.	 4	Station 4 Preset Button: has no CD/Radio function. Press and hold to set station 4 or pause iPod when docked in Docking Station.
 AUDIO	Audio Button: Selects treble, bass, fader or balance, audio settings.	 5 DEC -	Station 5 Preset Button: has no CD/Radio function. Press and hold to set station 5.
 BAND	Band Button: Selects from AM to FM band.	 6 DEC +	Station 6 Preset Button: has no CD/Radio function. Press and hold to set station 6.
 ZONE 1	Volume Buttons: Zone 1 buttons are used to adjust volume levels. Zone 2 buttons not used.	 TUNE	Tune Buttons: <ul style="list-style-type: none"> <li>• In CD mode: Advances/Rewinds tracks.</li> <li>• In radio mode: Selects radio stations.</li> </ul>
 ZONE 2		 TUNE	

*Note: Remote Control has no effect on MP3 player playback if/when the generic MP3 output cable is used.*



Optional ISC Adapter Kit Needed for These Button Functions, Part # 20230-001			
 LIGHT	Light Button: Controls light intensity: High - Med - Low		Jets 1 Button: Turns Jets pump 1 On and Off
 AIR	Air Button: Turns the Blower on and off		Jets 2 & 3 Button: Turns Jets pump 2/3 On and Off



## 23.8 Wireless Remote Battery Replacement Procedure

1. Start by removing the rubber cover to the remote (Figure A).

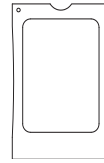
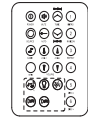


Fig. A



2. Turn the remote unit over and locate the battery door (Figure B).



Fig. B

Battery Door

3. Rotate the battery door, with a coin, counterclockwise until the dot aligns with the Open arrow (Figure C).

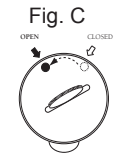


Fig. C

4. Remove battery door using coin to pry the door upward (Figure D).

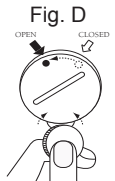


Fig. D

5. Replace battery using CR2025 or equivalent (Figure E).

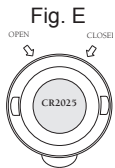


Fig. E

6. Reinstall the battery cover, using the coin to close (Figure F).

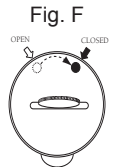


Fig. F

7. Reinstall rubber cover onto remote (Figure G).

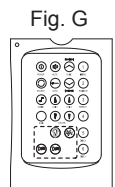
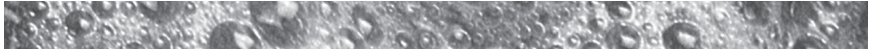


Fig. G

*Note: Remote unit is water resistant not waterproof, therefore the unit should be stored in a dry location within your home and never be left in the spa while the cover is on and spa is not in use.*



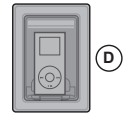
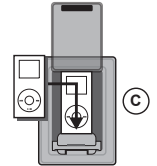
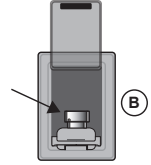
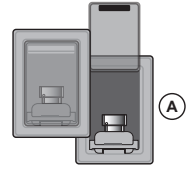
## 23.9 iPod™ Docking Station

### A. Docking Your iPod

The Docking Station for iPod is compatible with all dock able Apple iPod models.

To install Apple iPod:

1. Locate and open Docking Station door by gently pulling outward on handle as shown (A).
2. Remove the iPod connector cover (B), prior to plugging in your iPod. Always keep the cover on when the docking station is not in use.
3. Center the iPod over Docking Station Interface Port, then gently press downward as shown (C). **DO NOT FORCE!**
4. Close Docking Station door as shown (D), then refer to section below for stereo system iPod selection and operation details.



#### **WARNING:** Electrical Shock Hazard Exists!

- Never install or remove iPod while hands are wet or while sitting partially immersed or fully immersed in spa!




#### **CAUTIONS:**






- Never leave iPod in Docking Station when spa is not in use to prevent damage from outdoor elements!
- Never spray Docking Station with pressurized water hose for any reason! Damage to iPod or spa stereo system caused by water intrusion is not covered under the manufacturer warranty!
- Damage to Docking Station port or iPod due to excessive force or improper alignment during installation or removal from Docking Station is not covered under warranty.

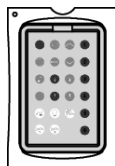


## B. Setting Up The iPod for Use

1. Select and play preferred song/album/playlist prior to docking iPod.
2. Press “Source Button”  on stereo receiver or remote until the display reads “CD-1”.

## C. Use Wireless Remote or Stereo to Operate iPod

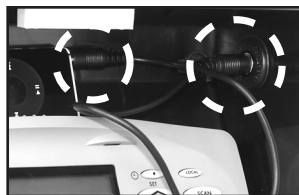
Button	Operation
Press 	Next Track
Press  & Hold	Fast Forward
Press  x 2	Return to Beginning of Current Track
Press  x 3	Recall Previous Tracks
Press 	Pause (Press Again to resume Play)




## 23.10 Generic MP3 Player Operation

### A. Connecting Your MP3 Player

1. Plug in any MP3 player’s headphone output jack with supplied cable into the auxiliary port as shown using the supplied audio RCA cable (iPod shown for demonstration purposes only).



### B. Setting Up The MP3 Player for Use

1. Select preferred song/album/playlist prior plugging in MP3 player and start playback.
2. Press “Source Button”  on stereo receiver or remote until the display reads “AU-1”.

*Note: All external MP3 player playback operations are performed solely by the MP3 Player with the exception of volume control and “Source Button” selector, which can be controlled via wireless remote or on the stereo receiver.*



### **WARNING: Electrical Shock Hazard Exists!**

Never install, handle or remove MP3 player while hands are wet or while sitting partially or fully immersed.



**The following UL requirements must be observed for all spas with optional stereo components installed.**

- A. "CAUTION - Risk of Electric Shock. Do not leave compartment door open",
- B. "CAUTION - Risk of Electric Shock. Replace components only with identical components", and
- C. "Do not operate the audio/video controls while inside the spa".
- D. "WARNING - Prevent Electrocution. Do not connect any auxiliary components (for example: cable, additional speakers, headphones, additional audio/video components etc.) to the system".
- E. These units are not provided with an outdoor antennae, when provided, it should be installed in accordance with Article 810 of the National Electric Code, ANSI/NFPA 70.
- F. Do not service this product yourself as opening or removing covers may expose you to dangerous voltage or other risk of injury. Refer all servicing to qualified service personnel.
- G. When the power supply connections or power supply cord(s) are damage; if water is entering the audio/video compartment or any electrical equipment compartment area; if the protective shields or barriers are showing signs of deterioration; or if there are signs of other potential damage to the unit, turn off the unit and refer to a qualified service personnel.
- H. This unit should be subjected to periodic routing maintenance (for example, once every 3 months) to make sure that the unit is operating properly.

P/N: 6530-509, Rev. A