

owner's manual



bullfrog<sup>®</sup>  
spas

## QUICK REFERENCE

To assist you with the installation and maintenance service of your new spa, please fill out the following information and keep it on hand for future reference.

### Spa Information

Spa Model: \_\_\_\_\_

Serial Number: \_\_\_\_\_

Dealership: \_\_\_\_\_

Dealer's Phone Number: \_\_\_\_\_

Date Purchased: \_\_\_\_\_

Date Installed: \_\_\_\_\_

### Contractor Information

#### General

1. Name: \_\_\_\_\_

Telephone: \_\_\_\_\_

2. Name: \_\_\_\_\_

Telephone: \_\_\_\_\_

#### Electrician

1. Name: \_\_\_\_\_

Telephone: \_\_\_\_\_

2. Name: \_\_\_\_\_

Telephone: \_\_\_\_\_

#### Concrete, Decking, and Masonry

1. Name: \_\_\_\_\_

Telephone: \_\_\_\_\_

2. Name: \_\_\_\_\_

Telephone: \_\_\_\_\_

#### Landscaping

1. Name: \_\_\_\_\_

Telephone: \_\_\_\_\_

2. Name: \_\_\_\_\_

Telephone: \_\_\_\_\_



## IMPORTANT OVERVIEW

Congratulations on your purchase of a Bullfrog Spa Series I, Series II, or SportX Series Hot Tub<sup>†</sup>. Bullfrog Spas are the world's only spas equipped with the patented JetPak System<sup>™</sup>. JetPak<sup>®</sup> technology delivers incredible power, maximum versatility and allows you to upgrade your spa's jetting with new JetPaks<sup>®</sup>, both now and in the future. **NOTE:** In this document, the terms "Spa" and "Hot Tub" are used interchangeably.

Take a moment to read this manual carefully as you set up and use your new spa. Following the instructions in this manual will ensure the safe, secure, and timely installation and operation of your new spa.

Carefully read this Owner's Manual **before** you install your spa. Your Bullfrog Spa Limited Warranty will be void if damage is caused by failure to install, maintain, and operate your spa in accordance with the recommendations contained in this Owner's Manual or any other printed instruction, notice or bulletin from Bullfrog Spas. Your spa's serial number is located both on the base under the equipment door and the Manufacturing ID Label located inside the equipment compartment of your spa.

For the safety of all those who utilize your spa and its surroundings, please make sure your spa and any adjoining installations, including the electrical hook-up, are completed only after acquiring any necessary approvals and permits from your local city and/or county. Follow all local and national safety and wiring rules. Some jurisdictions require certain fencing and/or self-closing and self-latching gates to prevent accidental drowning in a pool or spa. Your spa cover comes with a locking system that meets the ASTM F1346-91 Standard for Safety Covers, which when properly used, may satisfy certain fencing and gating requirements.

**U.S. Patents:** 5,754,989, 5,987,663, 6,000,073, 6,092,246, 6,256,805, 6,543,067.

**New Zealand Patent:** 334,093

**Australia Patent:** 737,335

**Canada Patent:** 2,260,237

**Other patents pending worldwide**



Bullfrog Spas reserves the right to change features, specifications and design without notification and without incurring any obligation

<sup>†</sup> Bullfrog Spas is defined by three series and their respective models.

**Series I:** 682, 662, 552, 562, 462, 451, & 331

**Series II:** 362, 251, & 231

**SportX Series:** 162, 151, & 131



IPX5



# TABLE OF CONTENTS

---

## Important Overview

Introduction.....	iii
Safety Listings .....	iii

<b>Table of Contents.....</b>	<b>1</b>
-------------------------------	----------

## Important Safety Instructions

Safety Instructions .....	2
---------------------------	---

## Spa Start Up

Spa Features .....	5
Filling Your Spa .....	7

## Spa Operation & Controls

Control System .....	8
Spa & Yard Stereo.....	13

## JetPaks

Interchanging JetPaks.....	14
Jets .....	15

## Spa Water Chemistry

Chemicals .....	16
Maintaining Spa Water.....	16
Additional Chemical Needs .....	16
Super Sanitization .....	16
Cloudy Water Prevention & Control .....	17

## Spa Maintenance

Draining and Changing Spa Water.....	18
Filter Maintenance .....	19
Light Bulb & LED Replacement .....	20
Spa Shell Care .....	20
Spa Cabinet Care .....	20
Spa Cover Care .....	20
Miscellaneous Care .....	21
Pillow Care .....	21
Freeze Prevention .....	21
Low-Use & No-Use Periods .....	21

## Reference Material

Site Selection & Installation.....	23
Delivery Basics .....	26
Spa Dimensions Chart .....	27
Electrical Chaseways .....	28
Electrical Requirments.....	29
Diagnostic Messaging.....	36
Troubleshooting Guide .....	38

## Limited Warranty.....

Warranty Registration Card .....	41
Obtaining Service .....	43

# IMPORTANT SAFETY INSTRUCTIONS

---

## Save these instructions

### Safety Instructions

When installing and using this electrical equipment, basic safety precautions should always be followed, including the following:

1. **Read and follow all instructions:**
2. **▲WARNING:** To reduce the risk of injury, do not permit children to use this product unless closely supervised at all times.
3. As per UL requirements (U.S.), a wire connector is provided on this unit to connect a minimum No. 8 AWG (8.4mm<sup>2</sup>) solid copper conductor between this unit and any metal equipment, metal enclosures of electrical equipment, metal water pipe, or conduit within 5 feet (1.5m) of the unit.
4. **▲WARNING:** For products provided with a cord-connected, ground-fault circuit-interrupter, the GFCI must be tested before each use. If the GFCI fails to operate properly, disconnect the power until the fault has been identified and corrected.
5. **▲DANGER:** Risk of Accidental Drowning. Extreme caution must be exercised to prevent unauthorized access by children. To avoid accidents, ensure that children cannot use this spa unless they are supervised at all times.
6. **▲DANGER:** Risk of Injury. The suction fittings in the spa are sized to match the specific water flow created by the pump. Should the need arise to replace the suction fittings or the pump, be sure that the flow rates are compatible. Never operate the spa if the suction fittings are broken or missing. Do not replace a suction fitting with one rated less than the flow rate marked on the original suction fitting.
7. **▲DANGER:** Risk of Electric Shock. As per UL requirements (U.S.), install spa at least 5 feet (1.5m) from all metal surfaces. A spa may be installed within 5 feet (1.5m) of metal surfaces if each metal surface is permanently connected by a minimum of No. 8 AWG (8.4mm<sup>2</sup>) solid copper conductor to the wire connector on the terminal box that is provided for this purpose.
8. **▲DANGER:** Risk of Electric Shock. Do not permit any electrical appliances, such as a light, telephone, radio, or television within 5 feet (1.5m) of the spa. These units **DO NOT** have an integral ground fault circuit interrupter. The installation of an integral ground fault circuit interrupter **MUST** be completed by a qualified Electrician and must meet all applicable electrical codes.
9. For Cord-Connected units: a) Replace damaged cord immediately. b) Do not bury cord. c) Connect to grounded, grounding-type receptacle only.
10. **▲WARNING:** To Reduce the Risk of Injury:
  - a. Water temperature in a spa should never exceed 104°F (40°C). Water temperatures between 100°F (38°C) and 104°F (40°C) are considered safe for a healthy adult. Water temperature in excess of 104°F (40°C) may be injurious to your health. Lower temperatures are recommended for young children and/or when spa use exceeds 10 minutes.
  - b. Since excessive water temperatures have a high potential for causing fetal damage during the early months of pregnancy, pregnant, or possibly pregnant, women should limit spa usage when temperatures are in excess of 100°F (38°C).
  - c. Before entering the spa, measure the water temperature with an accurate thermometer since the tolerance of water temperature regulating devices varies.
  - d. The use of alcohol, drugs, or medication before or during spa use may lead to unconsciousness with the possibility of drowning.
  - e. Persons suffering from obesity or a medical history of heart disease, low or high blood pressure, circulatory system problems, and/or diabetes should consult a physician before using a spa.
  - f. Persons using medication should consult a physician before using a spa. Some medications may induce drowsiness while other medication may affect heart rate, blood pressure, and/or circulation.
11. **▲WARNING:** PEOPLE WITH INFECTIOUS DISEASES SHOULD NOT USE A SPA OR HOT TUB.
12. **▲WARNING:** TO AVOID INJURY, EXERCISE CARE WHEN ENTERING OR EXITING THE SPA OR HOT TUB.

13. **▲WARNING: DO NOT USE A SPA OR HOT TUB IMMEDIATELY FOLLOWING STRENUOUS EXERCISE.**
  14. **▲WARNING: PROLONGED IMMERSION IN A SPA OR HOT TUB MAY BE INJURIOUS TO YOUR HEALTH.**
  15. **▲CAUTION: MAINTAIN WATER CHEMISTRY IN ACCORDANCE WITH MANUFACTURER'S INSTRUCTION.**
  16. **▲CAUTION: TEST THE GROUND FAULT CIRCUIT INTERRUPTER BEFORE EACH USE OF THE SPA.**
  17. **▲CAUTION: ADEQUATE DRAINAGE MUST BE PROVIDED IF THE EQUIPMENT IS TO BE INSTALLED IN A PIT.**
  18. **▲WARNING: Risk of Fatal Hyperthermia.** Hyperthermia occurs when the internal temperature of the body reaches a level several degrees above the normal body temperature of 98.6° F (37° C). The symptoms of Hyperthermia include dizziness, lethargy, drowsiness, and fainting. The use of alcohol, drugs, and/or medication can greatly increase the risk of fatal Hyperthermia. The effects of Hyperthermia include:  
Unawareness of impending hazard  
Failure to perceive heat  
Failure to recognize the need to exit the spa  
Physical inability to exit the spa  
Fetal damage in pregnant women  
Unconsciousness and danger of drowning
  19. **▲WARNING: Risk of Children Drowning.** Your spa cover is not rated as a safety cover. It is always wise to keep the spa cover securely fastened when not in use. This will help discourage children from attempting to enter the spa unsupervised.
  20. **▲WARNING: Risk of Drowning.** Use caution when bathing alone. Overexposure may cause nausea, dizziness, and fainting.
  21. **▲CAUTION: Risk of Injury.** Young children should be supervised so that they do not play with the appliance.
  22. **▲WARNING: Risk of Injury:** To avoid injury, exercise care when entering or exiting the spa. Surfaces can be slippery when wet. Do not step or sit on headrests or FilterCap™. Also, keep all breakable objects away from the spa area.
  23. **▲WARNING: Risk of Injury:** Short-term inhalation of high concentrations of ozone and long-term inhalation of low concentrations of ozone can cause serious physiological effects.
  24. **▲CAUTION: Unauthorized Access.** Secure the spa area against unauthorized access. Make sure all spa barriers (fences, enclosures, etc.) meet all applicable national and local codes. Keep spa cover on and locked when it is not being used.
  25. **▲CAUTION: Risk of Damage to Spa or Equipment.** By performing maintenance as described in this manual, the chance of damage to your spa and its equipment will be reduced. Never block the air vents that lead to the spa's equipment compartment, doing so may cause the spa to overheat.
  26. **▲WARNING: Risk of Electric Shock or Death.** Do not operate spa during severe weather conditions (e.g. electrical storms, tornadoes, etc.).
  27. **▲CAUTION: Non-Approved Accessories.** Using accessories not approved by Bullfrog International, LC could void your warranty or cause other problems. Please consult your authorized Bullfrog Spa dealer.
  28. **▲CAUTION: Location of Your Spa.** Locate your spa on a foundation that can support the maximum filled weight of your spa along with the weight of all the occupants using the spa (see Site Selection and Preparation). Also, locate your spa in an environment that can withstand repeated exposure to water and the possibility of a major spill.
  29. **▲CAUTION: Cordage** shall be replaced only with a special cordage assembly available from the Manufacturer, its Service Agent, or similarly qualified persons in order to avoid a hazard.
  30. **▲WARNING:** This appliance is not intended for use by young children or infirm persons without supervision.
  31. **▲WARNING:** Before obtaining access to supply terminals, all supply circuits must be disconnected.
- ▲WARNING: Risk of Injury or Accidental Drowning:** Do not use spa without filters and FilterCaps™ installed. The filters and FilterCap serve as a barrier against bodily entrapment against the filter suction fitting(s).

## Additional Instructions

(Canadian Installations Only):

32. A green-colored terminal or a terminal marked G, GR, Ground, Grounding or the international grounding symbol is located inside the supply terminal box or compartment. To reduce the risk of electric shock, this terminal must be connected to the grounding means provided in the electric supply service panel with a continuous copper wire equivalent in size to the circuit conductors supplying this equipment.
33. At least two lugs marked "BONDING LUGS" are provided on the external surface or on the inside of the supply terminal box or compartment. To reduce the risk of electric shock, connect the local common bonding grid in the area of the spa or hot tub to these terminals with an insulated or bare copper conductor not smaller than No. 6 AWG.
34. All field-installed metal components such as rails, ladders, drains, or other similar hardware located within 10 feet (3m) of the spa or hot tub shall be bonded to the equipment grounding bus with copper conductors not smaller than No. 6 AWG.
35. **▲WARNING:** Risk to Infants, Elderly, and Women Planning or Experiencing Pregnancy. Please consult your physician if the above applies to you or anyone using the spa.

## Warning Signs

<b>▲ WARNING</b>	
DURING PREGNANCY, SOAKING IN HOT WATER MAY CAUSE DAMAGE TO THE FETUS. LIMIT USE TO 10 MINUTES AT A TIME.	
<b>PREVENT DROWNING</b> 1. SPA HEAT SPEEDS UP THE EFFECTS OF ALCOHOL, DRUGS, OR MEDICINE AND CAN CAUSE UNCONSCIOUSNESS. 2. IMMEDIATELY LEAVE SPA IF UNCOMFORTABLE OR SLEEPY.	<b>PREVENT CHILD DROWNING</b> 1. WATER ATTRACTS CHILDREN. ALWAYS ATTACH A SPA COVER AFTER EACH USE.
<b>PREVENT INJURY</b>	
1. ALWAYS CHECK WATER TEMPERATURE BEFORE ENTERING SPA. WATER TEMPERATURE SHOULD NOT EXCEED 104°F (40°C).	

<b>▲ WARNING</b>	
<b>PREVENT DROWNING</b> 1. SUPERVISE CHILDREN AT ALL TIMES. 2. ATTACH SPA COVER AFTER EACH USE. 3. SPA HEAT CAN CAUSE HYPERTHERMIA AND UNCONSCIOUSNESS. 4. SPA HEAT IN CONJUNCTION WITH ALCOHOL, DRUGS, OR MEDICATION CAN CAUSE UNCONSCIOUSNESS.	<b>PREVENT ELECTROCUTION</b> 1. NEVER PLACE ANY ELECTRIC APPLIANCE WITHIN 5 FEET OF SPA.
<b>PREVENT INJURY</b>	
1. ALWAYS CHECK WATER TEMPERATURE BEFORE ENTERING SPA. WATER TEMPERATURE SHOULD NOT EXCEED 104°F (40°C).	
NOTE: THIS MARKING IS TO BE REMOVED ONLY BY THE OWNER.	

<b>▲ WARNING</b>	
<b>PREVENT DROWNING</b> SUPERVISE CHILDREN AT ALL TIMES. ATTACH SPA COVER AFTER EACH USE. SPA HEAT CAN CAUSE HYPERTHERMIA AND UNCONSCIOUSNESS. SPA HEAT IN CONJUNCTION WITH ALCOHOL, DRUGS, OR MEDICATION CAN CAUSE UNCONSCIOUSNESS.	<b>PREVENT ELECTROCUTION</b> 1. NEVER PLACE ANY ELECTRIC APPLIANCE WITHIN 5 FEET OF SPA.
<b>PREVENT INJURY</b>	
1. ALWAYS CHECK WATER TEMPERATURE BEFORE ENTERING SPA. WATER TEMPERATURE SHOULD NOT EXCEED 104°F (40°C).	

Included with the spa are three warning signs to inform users and guests of the risk involved with using a spa. All of these warning signs are suitable for indoor and outdoor use. Place these warning signs in a noticeable place adjacent to the spa. For free additional copies, contact your authorized Bullfrog Spa Dealer.



# SPA START UP

## Spa Features

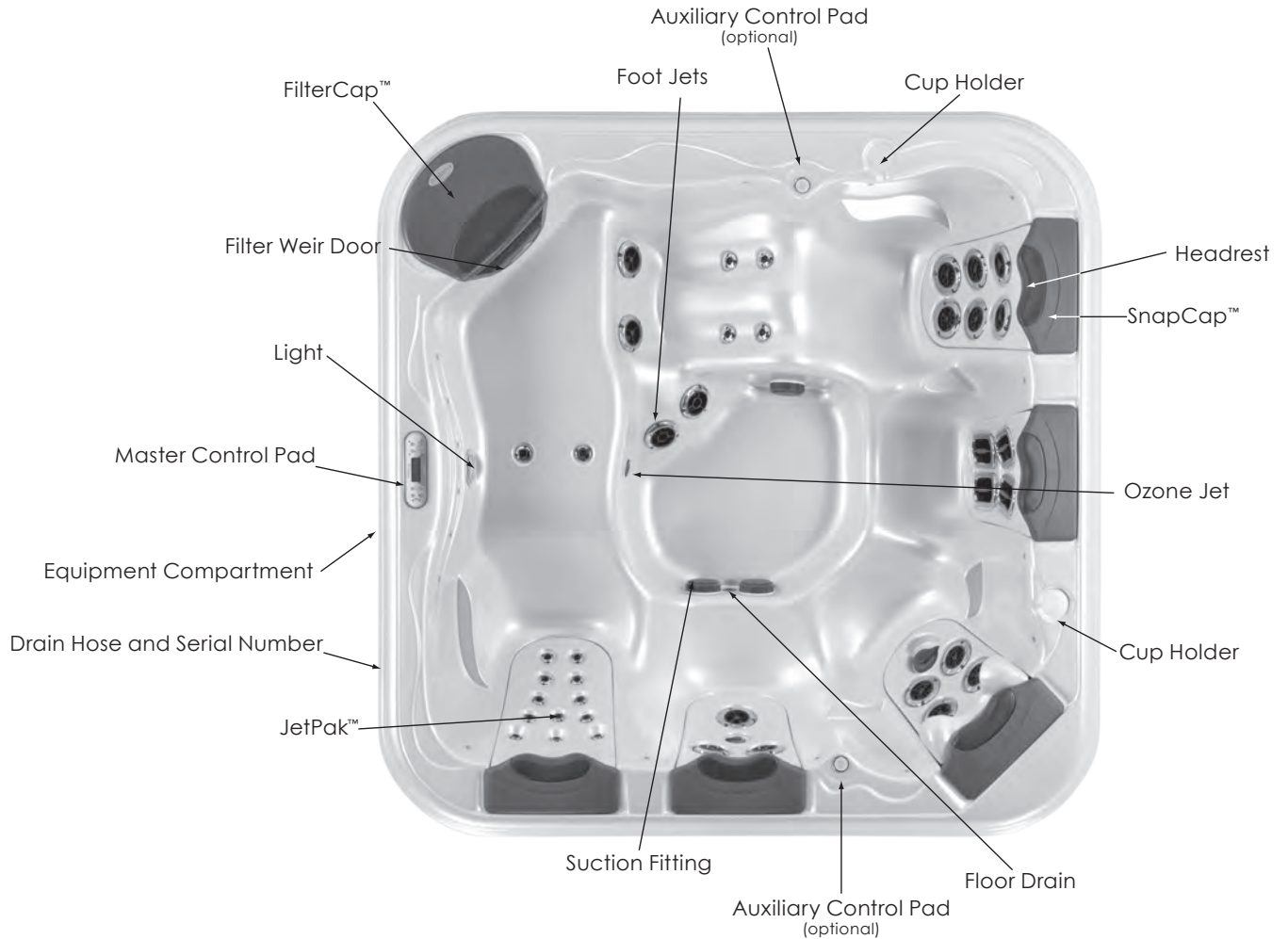

Top View of Spa (Model 552 Shown)

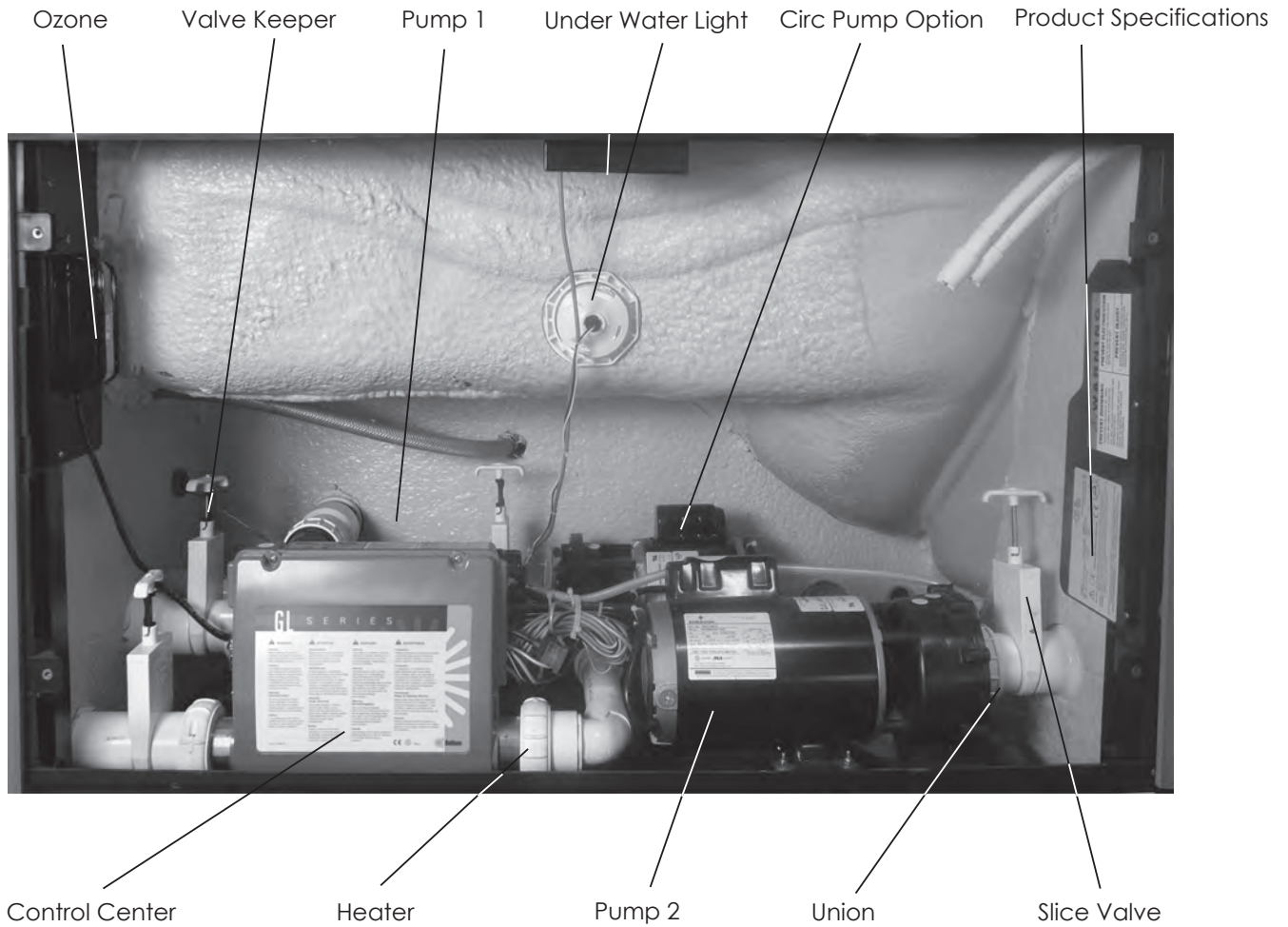

**Equipment Compartment** (Model 552 Shown)

## Filling Your Spa

**▲WARNING:** An empty spa (spa without water in it) must not be left exposed to sunlight as shell damage may occur. Once the spa is unwrapped, fill spa with water immediately or shade the spa with cover or wrapping to prevent direct exposure to sunlight.

**Important:** Do not turn power on to the spa without water in the spa. Serious damage to the pump and heater may occur.

**Step 1: Tighten Equipment Fittings:** Remove the equipment door by unscrewing the four screws. Hand tighten all PVC pipe unions located in the equipment compartment. This will prevent the possibility of a leak.



**Step 2: Check Slice Valve Keepers:** Verify that a slice valve keeper is installed on each slice valve. Slice valve keepers prevent the slice valve from vibrating shut during shipment or operation. A slice valve that closes will result in a noisy pump due to the lack of water flow.



**NOTE:** Slice valves are not installed on the models 331, 231, 251, 362, 131, 151, or 162 models. For Series II or SportX Series spa models, omit this step.

**Step 3: Fill the Spa:** Use a garden hose to fill the spa to the water level indication mark on the faceplate of the filter assembly.

**NOTE:** The higher the water level in the spa, the fewer spa users the spa will accommodate before overflowing.

**NOTE:** For complete instructions on filling the spa, refer to *Changing Spa Water*.

**IMPORTANT:** Never fill the spa with soft water unless an appropriate mineral supplement is immediately added (see your authorized Bullfrog Spas Dealer). If your water is extremely hard, it is preferable to either dilute the water's hardness by blending the water with water from a water softener, or by the addition of a special water softening chemical (see your authorized Bullfrog Spas Dealer).

**Step 4: Check for Leaks:** After the spa is filled, check all fittings and equipment in equipment compartment for signs of leakage **before** turning on the spa. Turn on pump(s), once again, check for leakage. If a leak is detected, tighten the fitting by hand. If the leak persists contact your authorized Bullfrog Spas Dealer.

**Step 5: Install Cover:** The spa cover comes with tie-down straps and locking hardware that attaches the cover to the spa or decking. If your dealer did not install the cover, refer to the Cover Installation Instructions included with the cover.



# SPA OPERATION & CONTROLS

## Control System

**IMPORTANT:** Each Bullfrog Spas Series I Spa is manufactured with a Premier Control System. Each Series II or SportX Series Hot Tub is manufactured with a Classic Control System. Refer to the control pad diagrams and instructions to help identify your specific control system.

### Classic Control Systems (Series II & SportX Series)

#### General



Classic Control Systems

Pump 1 (in low speed) is the pump which provides filtration and heating. In this section, the pump providing the filtration and heating is referred to as the “filter” or “filtration” pump.

Some functions require pressing multiple buttons on the control pad in a certain sequence. This is indicated by a “+” sign in the instruction (for example: press **temp + light** to enter mode programming). Do not press the buttons at the same time or even too quickly, or the desired result may not occur.

Timeouts refer to a preset length of time that a function is programmed to operate before shutting off automatically. Certain conditions (filter or freeze) can cause a function to operate longer, while faults can cause a function to operate for a shorter length of time. The system keeps track of timeouts regardless of other conditions.

## Initial Startup

Before turning on the power to the spa, make sure the spa is properly filled with water. When your spa is first powered up, it will automatically go into “Priming mode”, which will last about 4 minutes. Press **warm** to exit the Priming mode early. Once the Priming Mode is finished, the control system will turn on the pump 1 and begin to heat the water in Standard mode.

### Setting the Temperature: 78°F-104°F (26°C-40°C)

Once the pump 1 has been running for at least 2 minutes, the actual water temperature will be displayed on the Liquid Crystal Display (LCD) on the control pad. Note: Any time the spa pump 1 has not been running for a period of time, the LCD display will usually read “---”, which means the temperature is unknown because the temperature sensors in the heating unit require the water to be circulating past them for a couple minutes before calculating a true water temperature reading.

Unless changed by the user, the default temperature is factory set to 100°F (38°C). To change the spa water temperature, press **warm** or **cool** once to display the current set temperature, then within 2 seconds press **warm** to raise set temperature or **cool** to lower set temperature. Pressing **warm** or **cool** multiple times raises or lowers set temperature one degree each time the button is pressed. After 3 seconds without pressing **warm** or **cool**, the LCD will again display the current spa water temperature.

## Spa Operating Modes

Press **mode/prog** to enter mode programming, then press **cool** to cycle through the operating modes (Standard, Economy and Sleep). Select the desired mode by pressing **mode/prog**.

- **Standard Mode:** which is the factory default setting, checks and maintains the set temperature of the spa water every 30 minutes. Standard Mode is preferable when your spa will have steady, every day use, because this mode maintains the spa water at the set temperature and is always ready for use. The drawback of Standard Mode is the pumps and heater cycle on every thirty minutes throughout the day, and therefore this mode uses more electricity than other modes. “Standard” will appear in the display when in Standard Mode.
- **Economy Mode:** only heats the water during filter cycles—usually twice a day. Economy Mode is named such because it uses less electricity than Standard Mode. However, since Economy Mode only maintains and heats water temperature during filtration cycles, the spa water temperature may drop a few degrees between the filter cycles depending on outside

temperatures. For this reason, most spa owners using Economy Mode set their filter cycle times to correspond with the times of day when they are most likely to use their spa so the spa water is up to temperature and ready for use. Economy Mode is preferable for those who use their spa intermittently (2-3 times per week). When in Economy Mode, “Economy” will appear in the display. When **jets** is pressed in Economy Mode, the spa goes into “Standard-In-Economy” mode (SE). The benefit of the SE feature is the spa water will heat between filtration cycles (assuming **jets 1** is pressed) allowing someone to use the spa. The spa reverts back to Economy mode automatically after 1 hour.

- **Sleep Mode:** heats the spa during filter cycles to about 20°F (11°C) lower than the set temperature. The Sleep Mode uses the least electricity of any of the modes, but since it takes several hours to bring the spa water back up to set temperature, Sleep Mode is only recommended if the spa will not be used for 2-3 weeks or more. In Sleep Mode, “Sleep” will appear on the display.
- **Standby Mode (Sby):** Standby Mode idles all of the spa’s functions and should be used when changing a filter or a JetPak, otherwise the pumps can automatically turn on at the start of a filtration cycle. Press **temp** then **jets 2** (or **aux**) to enter Standby mode. Press any button to exit. This mode will time out after two hours.

## Jets

Press **jets** to turn pump 1 on and off and to shift between low and high speeds. If left running, the low speed will automatically turn off after 2 hours and the high speed will turn off after 30 minutes. Pump 1 turns on in low speed automatically during filter cycles, and it cannot be turned off with the control panel **jets** switch.

NOTE: When in standard mode, the pump 1 will activate for at least 2 minutes every 30 minutes to detect the spa temperature and will heat to set temperature (if needed).

## Jets 2 (only available on 2 pump spas)

If your spa is equipped with a two jet pump system, press **jets 2** to turn pump 2 on or off and to shift between low and high speeds. If left running, the pump will turn off automatically after 30 minutes.

NOTE: If the spa does not have two pumps, the **jets 2** button will be labeled **aux** on the control pad.

## Light

Press **light** to toggle the light on and off. The light will turn off automatically after 4 hours.

## Preset Filter Cycles

There are two filter cycles per day. The first filter cycle begins 6 minutes after the spa is powered up. The second filter cycle begins 12 hours after the start of the first cycle. Most spa owners with classic control systems power up their spa at approximately 6:00-7:00 a.m. so the morning and evening filtration cycles are close to when the spa is most likely to be used (see “Economy Mode” paragraph above). The filtration pump and ozone purifier\* run during filtration cycles. In addition, all jet pumps will run for the first 10 minutes of each filter cycle to purge the JetPaks™ and JetPods™. The factory filter cycle duration is set for 2 hours twice per day. Filter cycle duration can be programmed by the spa owner for one hour up to 12 hours (F1-F12).

To change the filter cycle duration, press **warm + jets 1**. Press **warm** to cycle through the 1 to 12 hour filter duration options (F1-F12). Press **jets 1** to select the desired filter duration. Press **warm** again to cycle through the options for number of filter cycles per 24 hour period. The display will show three options: “dn” (for day and night), “d” (day only), or “n” (night only). Press **jets 1** to select desired option. Press **jets 1** again to exit the program.

Note: For most applications, “dn” (day and night) filter cycles is recommended as two 2-hour filter cycles 12 hours apart is better than one 4 hour filter cycle once per day. For continuous filtration, use F12 and dn. Allowing the pump 1 to operate for extended periods of time with the cover on the spa will result in a rise of the spa water temperature. During warmer months of the year, it is advisable to set the duration of the filtration cycle to the minimum level needed to keep the water clean.

## Freeze Protection

If the temperature drops to 44°F (7°C) within the heater, the pump(s) automatically activates to provide freeze protection. The pump will stay on 4 minutes after the sensor has detected the temperature has reached 44°F (7°C) or higher.

## \*Ozone Purifier (optional)

The ozone purifier runs during filter cycles. The ozone is disabled during spa use by either turning pump 1 to high speed or pump 2 to high or low speed

## Premier Control System (Series I Spas)

### General



Premier Control System

In spas equipped with an optional WellSpring circulation pump (referred to as “circ pump”), this circ pump acts as the filtration and heating pump for the spa water. For standard spas not equipped with a circ pump, Pump 1 (in low speed) is the pump which provides filtration and heating. In this section, the pump providing the filtration and heating (whether the circ pump or pump 1) is referred to as the “filter” or “filtration” pump.

Some functions require pressing multiple buttons on the control pad in a certain sequence. This is indicated by a “+” sign in the instruction (for example: press temp + light to enter mode programming). Do not press the buttons at the same time, however do press the buttons one right after another within 3 seconds.

Timeouts refer to a preset length of time that a function is programmed to operate before shutting off automatically. Certain conditions (filter or freeze) can cause a function to operate longer, while faults can cause a function to operate for a shorter length of time. The system keeps track of timeouts regardless of other conditions.

### Initial Startup

Before turning on the power to the spa, make sure the spa is properly filled with water. When your spa is first powered up, it will automatically go into Priming mode (Pr) that will last for up to 4 minutes. Press **warm** or **cool** to exit the Priming mode early. Once the priming mode has completed, the control system will turn on the filter pump and begin to heat the water in Standard mode.

### Setting the Time

After initial Prime mode, the TIME icon will appear on the control panel's liquid crystal display (LCD). To set the time, press **time + mode/prog**. Select the hour by pressing **warm** (to increase

hour) or **cool** (to decrease hour). Each press changes the time by 1 hour. Once the hour is correct, press **mode/prog** to enter the correct hour and switch to minutes. Select minutes by pressing **warm** (for up) or **cool** (for down). Each press changes the time by 1 minute. Either press **time** to save current time and exit, or if desired, press **mode/prog** to enter the optional filter cycle programming (see Custom Filter Cycles later in this section).

**NOTE:** In the event of power loss to the spa, the time setting is saved for up to 72 hours.

### Setting the Temperature: 80°F-104°F (26°C-40°C)

Once the filter pump has been running for at least 2 minutes, the actual water temperature will be displayed on the Liquid Crystal Display (LCD) on the control pad.

Note: Any time the spa filter pump has not been running for a period of time, the LCD display will usually read “----”, which means the temperature is unknown as the temperature sensors in the heating unit require the water to be circulating past them for a couple minutes before calculating a true water temperature reading.

Unless changed by the user, the default temperature is factory set to 100°F (38°C). To change the spa water temperature, press warmer or cooler once to display the current set temperature, then within 2 seconds press **warm** to raise set temperature or **cool** to lower set temperature. Pressing **warm** or **cool** multiple times raises or lowers set temperature one degree each time the button is pressed. After 3 seconds without pressing **warm** or **cool**, the LCD will again display the current spa water temperature.

### Spa Operating Modes

Press **mode/prog** to enter mode programming, then press **cooler** to cycle through the operating modes (Standard, Economy and Sleep). Select the desired mode by pressing **mode/prog**.

- **Standard Mode (Std):** which is the factory default setting, checks and maintains the set temperature of the spa water every 30 minutes. Standard Mode is preferable when your spa will have steady, every day use, because this mode maintains the spa water at the set temperature and is always ready for use. The drawback of Standard Mode is the pumps and heater do cycle on every thirty minutes throughout the day, and therefore this mode uses more electricity than other modes. “Standard” will appear in the display when in Standard Mode.

- **Economy Mode (Ecn):** only heats the water during filter cycles—usually twice a day. Economy Mode is named such because it uses less electricity than Standard Mode. However, since Economy Mode only maintains and heats water temperature during filtration cycles, the spa water temperature may drop a few degrees between the filter cycles depending on outside temperatures. For this reason, most spa owners using Economy Mode set their filter cycle times to correspond with the times of day when they are most likely to use their spa so the spa water is up to temperature and ready for use. Economy Mode is preferable for those who use their spa intermittently (2-3 times per week). When in Economy Mode, “Economy” will appear in the display. When **jets 1** is pressed in Economy Mode, the spa goes into “Standard-In-Economy” mode (SE). The benefit of the SE feature is the spa water will heat between filtration cycles (assuming **jets 1** is pressed) allowing someone to use the spa. The spa reverts back to Economy mode automatically after 1 hour.

- **Sleep Mode (SLP):** heats the spa during filter cycles to about 20°F (11°C) lower than the set temperature. The Sleep Mode uses the least electricity of any of the modes, but since it takes several hours to bring the spa water back up to set temperature, Sleep Mode is only recommended if the spa will not be used for 2-3 weeks or more. In Sleep Mode, “Sleep” will appear on the display.

### Standby Mode (Sby)

Standby Mode idles all of the spa’s functions and should be used when changing a filter or a JetPak, otherwise the pumps can automatically turn on at the start of a filtration cycle. Press temp then **jets 2/aux** to enter Standby mode. Press any button to exit.

### Filter Cycles

Filter cycles are preset at the factory to run twice per 24 hour period—one starting at 8:00 a.m. and one starting at 8:00 p.m. These times are based on the internal spa clock. The filtration pump (either pump 1 or optional circ pump) and the ozone purifier\* (see Ozone Purifier section) run during filtration cycles. In addition, all jet pumps will run for the first 10 minutes of each filter cycle to purge the JetPaks™ and JetPods™. The factory setting filter cycle duration is set for 2 hours each cycle (4 hours per day) for non-circ models, and 6 hours each cycle (12 hours per day) for circ pump models. Filter cycle start and end times, as well as filter cycle duration can be custom programmed by the spa owner.

### Custom Filter Cycles:

Note: To ensure adequate water filtering, Bullfrog recommends that custom filter cycles be at least 2 hours twice per day for non-circ pump models and 6 hours twice a day for circ pump equipped models. Bullfrog also recommends filter cycles be programmed to begin 12 hours apart, as two 2 hour filter cycles 12 hours apart is better than one 4 hour filter cycle in a day. Since Bullfrog Spas are so well insulated, programming the filter pump to operate for extended periods of time with the cover on the spa will result in a rise of the spa water temperature. During warmer months of the year, it is advisable to set the duration of the filtration cycle to the minimum level needed to keep the water clean.

To program custom filter cycle settings, press **time + mode/prog + mode/prog + mode/prog** within 3 seconds. The PROGRAM, FILTER 1, and START TIME icons will appear on the display. Press **warm** or **cool** to choose filter cycle 1 start time hour. Press **mode/prog** to save the hour. Press **warm** or **cool** to choose the filter 1 start time minutes. Each press changes the start time by 5 minutes. Press **mode/prog** to enter the minutes. Press **mode/prog** to see the PROGRAM, FILTER 1, and END TIME icons. Adjust the filter 1 cycle end time hour and minutes as outlined above using the **warm** or **cool** and **mode/prog** buttons. Next press **mode/prog** to see the PROGRAM, FILTER 2, and START TIME icons. Proceed as outlined above to enter the filter 2 start and end times. After the filter 2 end time is entered, press **mode/prog** to confirm the new filter cycle times into the system and display the current water temperature. Press **time** at any time during filter cycle programming sequence to save the values entered up to that point and exit programming.

### Jets 1

Press **jets 1** to turn pump 1 on and off and to shift between low and high speeds. If left running, the low speed will automatically turn off after 2 hours and the high speed will turn off after 30 minutes. In non-circ pump spas, pump 1 turns on in low speed automatically during filter cycles, and it cannot be turned off with the control panel **jets 1** switch.

NOTE: When in standard mode, the filter pump (either pump 1-low speed or optional circ pump) will activate for at least 2 minutes every 30 minutes to detect the spa temperature and will heat to set temperature (if needed).

### Jets 2 (only available on two pump spas)

If your spa is equipped with a two jet pump system, press **jets 2** to turn pump 2 on or off and to shift between low and high speeds. If left running, the pump will turn off automatically after 30 minutes.

### Auxiliary Jet(s) Control

An optional auxiliary control pad(s) on the side of the spa can also activate the pump(s). NOTE: This option is not available on Series II or SportX Series Hot Tub models.

### Light

Press **light** to toggle the light on and off. The light will turn off automatically after 4 hours.

### LED Light (optional)

Press light button to turn the LED light on and off. To toggle between all the LED light options, press the **light** button on, then off, then wait about 1 second and turn on again. A different color option will appear. The LED light will turn off automatically after 4 hours.

### Option

This button does nothing by itself; however, it is used as part of the Invert sequence described below.

### Invert Display

Press **warm** or **cool** + **option** to change the orientation of the LED display.

### Freeze Protection

If the temperature drops to 44°F (7°C) within the heater, the pump automatically activates to provide freeze protection. The pump will stay on 4 minutes after the sensor has detected the temperature has reached 45°F (7°C) or higher.

### Locking the Control Panel

Press **time** + **jets 1** + **warm** within 3 seconds to lock the control pad. When locked, the Panel Lock (PL) indicator light will light. All buttons will be frozen except the time button. To unlock the panel, press **time** + **jets 1** + **cool**.

### Locking the Set Temperature

Press **warm** or **cool** + **time** + **jets 1** + warmer within 3 seconds to activate the lock. The TL indicator light will light when the set temperature is locked. To unlock the set temperature, press **warm** or **cool** + **time** + **jets 1** + **cool**.

### \*Ozone Purifier (optional)

The ozone purifier runs during filter cycles. The ozone is disabled during spa use by either turning pump 1 to high speed or pump 2 to high or low speed (for non-circ spas), or, for a circ pump spa, by turning pump 1 or pump 2 on at any speed.

### Icon Legend



Heat Icon - Indicates different stages of heating



Jets Icon - Spins fast on high speed/spins slow on low speed



Light Icon





## Spa & Yard Stereo System™ (optional)

The Spa & Yard Stereo System includes an environment-rated, marine-grade audio system and CD player with spa-side controls and Bose® speakers. Enjoy a full-range of lifelike sound with wide, even dispersion for clean and clear audio while in your spa and in your yard. Before operation read and follow all safety procedures and warnings found in the Owner's Manuals for the speakers and audio system which are bundled with this product

### General Cleaning

The robust components and materials of the Spa & Yard™ Stereo System allow for normal care, maintenance, and exposure to water. For normal cleaning, use a mild dishwashing soap or a window cleaner. For stubborn stains and water deposits, use a mild liquid cleaner or a mild detergent. To apply these cleaners, use a soft, damp cloth or sponge. Rinse well and if desired, dry with a clean cloth.

### Raising Speakers to “Spa” Position

**Step 1:** While facing the stereo system, hold the left speaker with the right hand and lightly press it towards the hot tub until the back of the speaker makes contact with the speaker housing.

**Step 2:** While the speaker is pushed back, use the left index finger to depress the release button.



**Step 3:** Lift up the left speaker until both speakers are situated in the “spa” position.



**▲WARNING:** To avoid pinching, the operator must maintain control of the speaker with the hand indicated at all times during the raising and lowering of the speakers.

### Lowering Speakers to “Yard” Position

**Step 1:** While facing the stereo system, hold the left speaker with either hand and push the left speaker by the grill plate downward.



**Step 2:** Continue to push the left speaker down until both speakers are returned to the “yard” position and the left speaker is locked securely in place.



**NOTE:** The speaker locking mechanism only engages when speakers are situated in the “yard” position and affects only the left speaker.

# JETPAKS® & JETTING

## Interchanging JetPaks

**NOTE:** Due to its large amounts of plumbing and jets, the NeckBlaster and NeckMasseuse JetPaks will only fit in the Lounger or Recliner (corner seats) and not in the side seat locations.

**Step 1:** Put the spa in Standby mode, this will prevent the pump(s) from activating (see Control System).

**Step 2:** Carefully, remove the head rest and SnapCap™ by lifting upwards.



**Step 3:** Push the JetPak forward until you have enough room to reach the two PVC water unions and air-line union.

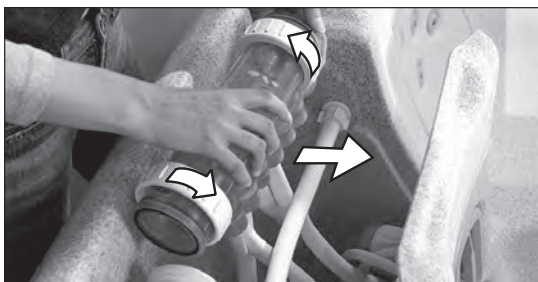

**Step 4:** Loosen the two PVC unions, pull the manifold out from in between the two water unions.

**Step 5:** Disconnect the air line union and remove the JetPak from the JetPod.



**Step 6:** Exchange JetPaks®.

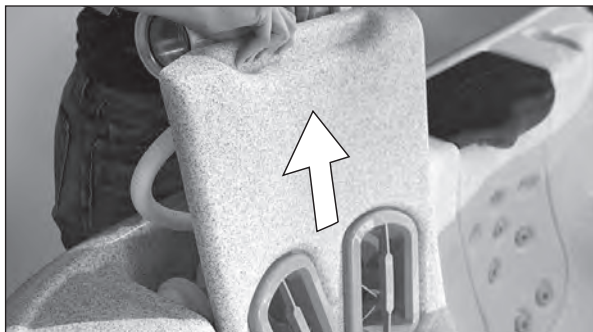

**Step 7:** Reattach the JetPaks by reversing steps

**NOTE:** When changing JetPaks, be aware that spa models with two pumps have an orange plug called a JetZone™ Divider factory installed in the mainchannel pipe either between seats 2 & 3 (for models 162, 362, 462, 562, 552) or between seats 3 & 4 (for models 662 & 682). Ensure this JetZone Divider remains in place during JetPak changing. This JetZone Divider isolates water being pumped from pump 1 from water being pumped by pump 2, and must remain in place for proper spa operation. **Never operate a two pump spa without a JetZone Divider in place as serious damage to the pump(s) may occur.** If you are missing this divider or have questions, please call your authorized Bullfrog Spas Dealer.



# Jetting

## Jet Types

A unique combination of the finest jets available are chosen to optimally balance each JetPak with ideal performance and massage intensity. You can achieve virtually limitless therapy options by adjusting many of the jets for a custom experience.

## Adjustable Jets

- To adjust the water flow on adjustable jets, simply turn the outer ring.
- To increase jet water pressure, turn the outer ring counter clockwise
- To decrease jet water pressure, turn the outer ring clockwise
- Some jets can be adjusted by means of a valve located directly on the JetPak.
- To increase jet pressure, turn the valve counter clockwise.
- To decrease jet pressure, turn the valve clockwise.

**NOTE:** Never shut all the jets off at the same time.



# SPA WATER CHEMISTRY

---

## Chemicals

Properly testing and treating your spa water is essential for the health of the spa as well as the people using it. Proper chemical maintenance will help control and prevent the following:

- Bacteria, algae, and fungi, which can spread disease and infection to humans
- Staining and scale build-up on the spa shell, equipment, and piping
- Clogged filters

## Starting the Spa with New Water

**IMPORTANT:** Never fill the spa with soft water unless an appropriate mineral supplement is immediately added. If your water is extremely hard, it is preferable to either dilute the water's hardness by blending the water with water from a water softener, or by the addition of a special water softening chemical. For more information, contact your authorized Bullfrog Spas Dealer.

**Step 1:** Add the prescribed dose of Stain and Scale Inhibitor while filling the spa. This will provide the initial protection against staining and scaling. Once the spa is filled, add the prescribed dose of Water Clarifier. This will clear the water of any micro-particulates that may be in the new water.

**Step 2:** If possible, have your authorized Bullfrog Spas Dealer test the calcium hardness (CH) of your spa water. Adjust the CH to 150-200 parts per million (PPM).

**Step 3:** Test and adjust the Total Alkalinity (TA). TA should measure 125 to 150 PPM.

**Step 4:** Test and adjust the pH. Water pH should measure 7.4 to 7.6.

**Step 5:** After the spa water has circulated for 1 hour, Super Sanitize the water by adding 10cc of Granular Chlorine (Dichlor-type only) or 20cc of Granular Bromine per 909.2l of spa water. (For complete details, refer to the Super Sanitation section.) After several hours, check sanitizer level and adjust, if necessary, to the following:

## Maintaining Spa Water

### Sanitizer and pH Levels

It is important to test and adjust the sanitizer and pH levels of your spa on a frequent basis. These tests should be performed prior to each use of the spa. At a minimum, it is recommended that you test the spa water 2-3 times a week, regardless of use.

Always test the pH level before you test the sanitizer level. If the pH level is not within the correct range (7.4-7.6), make the necessary adjustments.

## Additional Chemical Needs

Water conditions can be very different from region to region. Please have your local dealer perform a complete water analysis before or very soon after startup.

The following list of chemicals may be part of your chemical kit or may be necessary to your specific region. These can be further explained in the chemical kit or by your local dealer.

- Total alkalinity Increaser (PH Buffer)
- Calcium Hardness
- Stain & Scale Control
- Foam Control
- Water Clarifier

## Super Sanitation or Spa Shock

Normal sanitation does not eliminate Chloramines (trapped Chlorine), Bromamines (trapped Bromine), along with other non-filterable wastes, such as perspiration, oils, hair sprays, etc. that can build up in the water. These substances make the water unattractive in appearance and odor, and can interfere with sanitizer effectiveness. Super Sanitizing (or "shocking" or "Super Chlorinating") the spa water is achieved when the sanitizer level reaches or exceeds 10.0 PPM with granular Chlorine (Dichlor), or 22.0 PPM with granular Bromine (Bromine concentrate). Super Sanitation can also be achieved with a non-Chlorine shock (Potassium Peroxymonosulfate or equivalent). Shocking the spa water should be done at a regular interval at least once a week depending on use. Contact your authorized Bullfrog Spas Dealer for assistance.

When Super Sanitizing your spa water, you should allow the high level of sanitizer to off-gas by opening the spa cover at least half way for a minimum of 20 minutes. Failure to allow high concentrations of sanitizer to off-gas with the spa cover open may result in pillow and cover damage. Such damage is not covered under the terms of your spa's warranty.

**▲WARNING:** Fumes caused from off-gassing your spa can be hazardous. Please keep all children clear of the spa and surrounding areas until fumes have dissipated.

## Cloudy Water Prevention & Control

There are two basic reasons that spa water becomes cloudy. Non-filterable liquid waste (e.g. perspiration) have contaminated the water. To remove these substances, Super Sanitize the water. Or, non-filterable micro-particulate waste (e.g. dust) has contaminated the water. To remove these substances use a Water Clarifier.

▲**WARNING:** Trichlor Chlorine tablets should never be used in a portable spa. Dissolve rate, potency and the extreme low pH of this chemical can cause severe damage to the spa surface and components. Use of Trichlor Chlorine tablets will void the warranty.

▲**CAUTION: Important Instructions.** Always follow chemical manufacturers' instructions

▲**WARNING:** Never leave an open spa unattended, especially if there are children present



## SPA MAINTENANCE

**▲WARNING:** An empty spa (spa without water in it) must not be left exposed to sunlight as shell damage may occur. Once the spa is unwrapped, fill spa with water immediately or shade the spa with cover or wrapping to prevent direct exposure to sunlight.

### Changing Spa Water

As you use your spa, soap and detergent residues from your skin and bathing suits, along with other substances from maintaining the spa's water chemistry will accumulate in the spa water and make maintaining the water more difficult. Rinsing your bathing suits, and showering without soap prior to entering your spa will increase the life of your spa water. Depending upon usage, the spa water will need to be changed every 1-4 months or when the water chemical levels become difficult to manage. When changing spa water, remove all JetPaks®. Clean the shell and JetPod™ areas with a spa surface cleaner. See Spa Shell Care. Clean the other areas of the spa, including JetPaks, with a spa surface cleaner as necessary.

**IMPORTANT:** Drain your spa to an area that can handle a large quantity of water. If draining water onto vegetation, make sure that the sanitizer level (Chlorine or Bromine level) of the water is less than 0.5 PPM.

**▲WARNING:** Avoid drainage that can lead into basement window wells or any other area where damage could occur.

#### To Drain Your Spa\*:

**Step 1:** Turn-off main electrical breaker to spa.

**Step 2:** Locate drain below equipment compartment door.

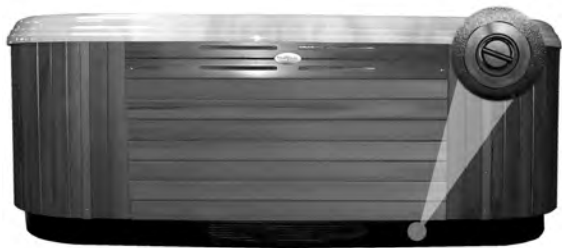

**Step 3:** Pull the drain out with a slight clockwise turn. Use pliers if needed.

**NOTE:** Drain is fully extended at approximately 2 inches (5 centimeters).



**Step 4:** Remove drain cap.

**NOTE:** The drain spout will not drain when fully extended.



**Step 5:** Attach a standard garden hose. Push the drain spout in halfway to actuate the drain.

**NOTE:** The Spa will drain about 5 gallons (20 liters) per minute. Ensure that the drainage is in an area safely away from window wells or basement entries.



**Step 6:** Once the spa is fully drained, pull the drain spout out all the way, remove hose, replace the drain cap and push drain in all the way.

## To Refill Your Spa:

▲**WARNING:** When refilling the spa, always Super Sanitize the new water by adhering to the instructions in the Water Chemistry section.

**Step 1:** To avoid air pockets in the pump(s), refill the spa with water by placing the hose into the filter compartment through the Weir door. Fill to the water level indication on the faceplate of the filter assembly.

**Step 2:** Restore electrical power supply.

**Step 3:** Press any button to reset the control system.

**Step 4:** Reattach the equipment compartment door.

**Step 5:** Following instructions in *Starting the Spa with New Water*.

**NOTE:** The higher the water level in the spa, the fewer spa users it will be able to handle.

## Filter Maintenance

It is recommended that blue pleated filter cartridge(s) be cleaned every 3-6 weeks or as needed. Replace the filter cartridge(s) every 1-2 years or when necessary. To maintain warranty protection, use only genuine Bullfrog Spas Filter Cartridge replacements. To clean or replace your filter cartridge(s), complete the following:

▲**CAUTION:** Never operate spa with the filter(s) removed.

**Step 1:** Place the spa in Standby mode.

**Step 2:** Remove FilterCap™.



**Step 3:** Remove cartridge(s).



**Step 4\*:** Using a garden hose with a nozzle or other high-pressure device, clean cartridge(s). Work top to bottom on each pleat.



- To remove collected suntan lotions or body oils, soak cartridge(s) in warm water with a Filter Cleaner or detergent.
- To remove calcium deposits, soak cartridge(s) in a plastic container using a 1:10 ratio of Muriatic acid to water solution. Calcium deposits indicate a high spa pH, which should be corrected.

**Step 5:** Reinstall cartridge(s) and FilterCap.

**Step 6:** Press any button to reset the control system.

**IMPORTANT:** Using a brush to clean a filter cartridge could cause damage to the cartridge.

\*Step 4 is omitted with the Bullfrog Disposable filters (Red or Gray in Color) that are installed on some Series I and Series II Bullfrog Spas. Disposable filters are an option for any Bullfrog Spa.

## Light Bulb Replacement

To replace a burned out or defective standard light bulb, complete the following:

**Step 1:** Turn off the electrical power at the breaker box.

**Step 2:** Remove the equipment compartment door.

**Step 3:** Locate the back of the light fixture.

**Step 4:** Grasp the light bulb holder (located on the back of the light fixture) and twist counter-clockwise to release the light from the fixture.

**Step 5:** Remove the light bulb by pulling it straight out of the light bulb holder.

**Step 6:** Replace the light bulb and reinstall the light bulb holder.

**Step 7:** Replace the equipment compartment door.

**Step 8:** Restore the electrical power supply.

**NOTE:** For alternate lighting systems, contact your authorized Bullfrog Spas Dealer.

### For LED replacement:

Contact your authorized Bullfrog Spas Dealer.

## Spa Shell Care

### General Cleaning

For normal cleaning, use a mild dishwashing soap, window cleaner, or other products recommended by your local authorized Bullfrog Spas Dealer. For stubborn stains, use a mild acrylic cleaner or a mild detergent. To apply these cleaners, use a soft, damp cloth or sponge. Rinse well and dry with a clean cloth. To clean hard water stains, remove light scratches and protect your spa shell, contact your authorized Bullfrog Spas Dealer.

### Cleaning the Scum Line

With normal use of the spa, oils, lotions, and hair products will build up on the surface of the water. This will leave a scum line around the perimeter. This can be easily removed using a spa surface cleaner or its equivalent. Avoid using cleaning agents that leave suds in the water.

**▲WARNING:** Never allow your spa surface to be exposed to alcohol, acetone (nail polish remover), nail polish, drycleaning solution, lacquer thinners, gasoline, pine oil, abrasive cleaners, or any other household chemicals other than those listed. These chemicals can void the warranty.

## JetPak™ Plumbing Care

For optimum spa care, each time the spa water is changed, remove all JetPaks. Clean the plumbing on the back of the JetPaks with a spa surface cleaner and a long, soft bristle brush. For cleaning the JetPak acrylic surface, refer to *Spa Shell Care*.

## Spa Cabinet Care

The EternaWood™ cabinet components are made to provide many years of maintenance-free service. For normal cleaning, use a mild dishwashing soap. For stubborn stains, contact your authorized Bullfrog Spas Dealer.

## Spa Cover Care

Your spa cover is warranted by its manufacturer. Although basic instructions are provided below, it is important that you refer to the information that came with the cover. The manufacturer provides detailed information on caring for your spa cover and what to do to protect its warranty.

**▲WARNING:** A non-secured or improperly secured cover may pose a safety threat to children and may also cause damage or injury if blown off by wind. Always remove entire cover before using the spa.

**IMPORTANT:** Do not stand, sit, or place any item on the cover that could damage it. Gently remove any snow accumulations over 2 inches (5cm). Do not use any cleaners other than those recommended by the manufacturer. Always secure the cover with all of the cover locks when not in use, whether the spa is empty or full of water.

### Cleaning the Spa Cover

At least monthly, clean the spa cover.

**Step 1:** Remove the cover and lay it down on a flat, clean surface near a garden hose.

**Step 2:** Rinse the cover to remove any loose debris.

**Step 3:** Clean the top (vinyl) of the cover with a mild solution of dishwashing soap, or other cleaner recommended by your local authorized Bullfrog Spas Dealer. Apply cleaner with a soft bristle brush. Using a gentle circular motion, scrub the cover, careful to not let any of the cover dry before rinsing with water.

**Step 4:** Rinse the cover thoroughly and dry with a clean cloth.

**Step 5:** Use saddle soap (never a petroleum-based product) to condition the cover per the manufacturer's instructions.



**Step 6:** Wipe and rinse any dirt from the bottom of the cover.

**Step 7:** Replace the cover and secure the locks.

**NOTE:** To remove tree sap, use lighter fluid (the type used in cigarette lighters). Use sparingly. Immediately, apply saddle soap to the area.

## Miscellaneous Care

### Cleaning and Protecting the Pillows

Regularly, clean all pillows with mild soap, water, and a clean cloth. Monthly, use a non-petroleum-based product.. This will maintain water resistance and luster of the product.

1. Don't sit on them or slide over them into the spa or they will tear.

2. **IMPORTANT:** Remove the pillows when shocking the spa or when sanitizer levels are high. Leave cover open for at least 30 minutes after shocking to ensure pillows are not affected.

**NOTE:** Pillow discoloration is caused by improper water chemistry and is not covered under the Bullfrog Spa Warranties.

### Vacuum the Spa

Debris from wind, trees, and users will occasionally accumulate on the bottom of the spa. The filtration system will remove the smaller debris; however, debris that is too large or heavy will have to be removed by a spa vacuum. If you do not have a spa vacuum, contact your authorized Bullfrog Spas Dealer.

## Freeze Prevention

In regions where low temperatures fall below 5°F (-15°C), it is recommended that a 5 cm insulation board or blanket be secured to the backside of the spa equipment compartment door.

**IMPORTANT:** When daytime outside temperatures reach 60°F (15°C), the equipment compartment insulation must be removed to prevent overheating of the equipment.

## Low-Use or No-Use Periods

During certain times of the year, you may not use the spa on a frequent basis. For these low-use or no-use periods, consider the following:

### No Use for Two to Six Weeks

If the spa will not be used for at least two weeks, lower the temperature to the lowest setting of 80°F (26°C) or place in Sleep Mode. Lowering the temperature will cut the cost of operation, however; you will need to adjust the temperature setting approximately 4 hours before use in order to heat the spa to 100°F (38°C).

**IMPORTANT:** During all low- and no-use periods, be sure to maintain the spa water as per the instructions in the Water Chemistry section.

**IMPORTANT:** For all no-use periods, and on a weekly basis, be sure to have someone visually check that the spa is functioning correctly and to also maintain the spa water as per the instructions under the Water Chemistry section. Not doing so may lead to corrosion, staining, and/or scaling to the spa and its equipment. During periods of freezing temperatures, a spa that has malfunctioned may be subject to damaged plumbing or equipment as a result of ice buildup within the spa. If the spa cannot be checked and maintained on a weekly basis, then consider winterization.

### No use for over six weeks

When you are not planning to use the spa for six or more weeks, or when someone is not able to maintain the spa on a weekly basis, you should winterize the spa. To winterize, follow these steps:

**▲WARNING:** Prior to winterizing your spa, it will be necessary to Super Sanitize the spa water as per the instructions in the Water Chemistry section. This procedure will help prevent the growth of bacteria, algae and fungi in any areas of plumbing that may not be fully free of water after you drain your spa for its period of winterization.

**Step 1:** Drain the water.

**Step 2:** Remove the drain plug from the pump(s), loosen all PVC pipe unions, and pump air-bleed valves in the equipment compartment. Do not replace the plugs, tighten the unions or close the air-bleed valves until the spa is de-winterized.

**Step 3:** Clean the entire spa.

**Step 4:** Remove filter cartridge(s) and clean. Allow filter to dry fully and store in a dry place.

**Step 5:** Secure the cover to the spa utilizing the tie downs and locking system. In areas where heavy snow is anticipated, place a large piece of plywood (or its equivalent) on top of the spa cover to assist in supporting the cover with the added weight of the snow. Remove snow off the cover following each snow storm.

**▲WARNING:** To avoid water from becoming trapped between the floor suction fitting and the filter pipe close the slice valve in front of the pump leading to the filter. Use a wet/dry vacuum to remove the remaining water out of pipe by placing the vacuum end over the filter hole. In a two-pump spa, first plug off one filter then vacuum out the water. Or pour 1-2 gallons (5-9 liters) of RV antifreeze into the filter hole. **NOTE:** RV antifreeze is nontoxic and does not require evacuation at start up.

### **Spa De-Winterization**

To de-winterize the spa, reverse the Winterization procedure. Refill to the water level mark.

**▲WARNING:** Whenever refilling the spa, it will be necessary to Super Sanitize the new spa water. Instructions are found in the Water Chemistry section.



## REFERENCE MATERIAL

---

### Site Selection & Installation

Before attempting to install or use your spa, please read Important Safety Instructions as well as all the installation instructions that follow.

### Site Selection and Preparation

Your home most likely offers multiple sites where your spa may be installed. Use the information presented in this section to assist you in carefully selecting the site that works best for you. It is your responsibility to choose and prepare the site properly **before** delivery, so you will experience a smooth and efficient delivery as well as obtain optimal use and full enjoyment of your spa.

### Environment

**Surroundings:** The direction that your spa will be facing will contribute to your overall bathing experience. Select the spa location that will provide optimal views based on your property layout. Consider your lifestyle and where you want to enjoy your spa and situate it accordingly. Indoor installations provide privacy, but create high levels of humidity (see Indoor Considerations). If your spa is outside, a nearby place for you and your guests to change clothes is a huge convenience. Also, a location near a house entry is convenient in areas with extreme winter climates.

**Indoor Considerations:** Indoor spa installations have special requirements. Your Bullfrog Spas is the most leak-free spa in the industry, but there is still a chance of a leak from any spa. The environment both around and below the spa should be water resistant, and preferably waterproof. It must be capable of handling water splashed out from the spa as well as the possibility of a leak. Recommendations to handle water around the spa include, but are not limited to, a floor drain and/or a catch basin equivalent to the volume of water in your spa. Condensation can also occur on the spa cover and drip onto the floor. Therefore, ensure that flooring materials provide a good grip when wet and are resilient to constant exposure of water and chemicals. In addition to handling the water from the spa, it is recommended that the room be properly ventilated. Humidity levels will naturally increase after the spa is installed and in use. Water may get into woodwork and produce dry rot, mildew, or other problems. Over time, high levels of humidity and spa chemicals can cause water damage to your floor, wall, and ceiling surfaces. Check for airborne moisture's effects on exposed wood, paper, and paint in the room. To minimize humidity damage, it is best to provide plenty of ventilation such as a ceiling fan and

moisture-resistant paint. An architect can help to determine if special ventilation equipment is required, such as a humidistat or dehumidifier which can be installed to regulate indoor humidity during spa use.

NOTE: Typical indoor surfaces include, but are not limited to concrete, wood, non-slip tile, or linoleum.

**Outdoor Considerations:** There are several considerations when installing your spa outdoors. 1. Avoid selecting a site where excessive water may contact the spa, such as sprinklers or a roof edge without rain gutters. 2. Avoid areas of direct, prolonged sunlight (if possible). The ultraviolet rays may fade or damage the spa cover and cabinet. 3. Check all applicable national and local codes regarding possible restrictions that require fencing or childproof gates around the spa. 4. Prevent dirt, sand, and foliage from being tracked into your spa by utilizing concrete, concrete pavers, or stone for paths and access areas (or, avoid positioning your spa in an area where debris will be tracked into the spa). Check the location of trees and spill paths from gutters to determine if wind or rain will sweep debris into your spa. 5. Consider your view and your privacy during all seasons of the year so your experience in your outdoor spa will be enhanced rather than limited.

NOTE: Typical outdoor surfaces include, but are not limited to concrete, brick, non-slip tile, wood decking, pea gravel, or sand.

### Spa Location

**Service Access:** Some people choose to install tile or custom wood around their spas. If you are installing your spa with custom trimming, remember to allow access for service. Should your spa need service, a technician may need to remove the spa's equipment compartment door or side panels, or access the spa from beneath. Also, it is always best to design special installations so the spa can still be moved, or lifted from the ground.

**Access to Circuit Breakers:** For service purposes, allow easy access to the circuit breakers in the electrical service panel (permanently-connected models), or to the interrupter switch on the end of the power cord (cord-connected models).

**Electrical Safety Requirements:** The installation of all spas must be in accordance with national and local wiring rules. Always have a licensed Electrician perform the electrical installation. Each Bullfrog Spa is manufactured and tested to a standard that provides maximum protection against electrical shock. Improper wiring may prevent the spa from operating

safely which could result in electrical shock, injury, or death. Improper wiring could also lead to a malfunction of the spa's equipment and risk of fire. When considering a location for your spa, consult with a licensed Electrician pertaining to the following:

- **Overhead Power Lines:** Based upon the national and local wiring rules that apply to your area, you will need to install your spa at the required minimum horizontal and vertical distances from all power lines.
- **Service Disconnect:** Based upon your area, a disconnect device must be incorporated into the fixed wiring in accordance with national and local wiring rules. If the national and local wiring rules permit, a GFCI Sub-Panel may be used to substitute the service disconnect, providing that it is located within the same parameters.
- **Electrical Outlets, Switches and Devices:** Based upon the national and local wiring rules that apply to your area, you must install your spa at the required minimum distance from all electrical outlets, switches, and devices.
- **Bonding:** Based upon the national and local wiring rules that apply to your area, the Control System Box located inside the equipment compartment of your spa must be bonded to all metal equipment, handrails, fixtures, enclosures, pipe, or conduit that are located within the maximum specified distances. The bonding is to be connected to the ground lug connector on the exterior surface of the Control System Box and all metal items previously described.
- **Equipment Compartment Access:** Make sure the spa is positioned so access to the equipment compartment will not be blocked.
- **All other national and local rules that may be applicable.**

**Water Drainage:** Avoid installing the spa in a pit or low area where water may accumulate and damage the spa or its equipment. Choose a site where water will drain away from the spa. Your spa contains an equipment compartment, which houses all of its electrical components. Allowing water into the equipment compartment can damage the electronics, or may result in tripping your spa's circuit breaker.

**Use of a Cover-Lifting Mechanism:** If using a cover-lifting mechanism, allow up to 18 inches (.61m) of clearance behind the spa. Check with your authorized Bullfrog Spas Dealer for the exact clearance requirements for the cover-lifting mechanism.

## Spa Foundation

**General Guidelines:** Select a structurally sound flat surface that is reasonably level to serve as your spa's foundation. A foundation that shifts or settles may cause stress to the spa shell. The foundation that your spa rests on must have a weight bearing load capability of supporting the weight of your spa, its water, and the people using it. The maximum filled weight of a spa can be as much as 6,000 lbs. (2,800kg), plus the weight of the occupants that use the spa (for the weight bearing load requirements as well as the maximum filled weight of your spa, refer to the Spa Technical Specifications Chart or contact your local authorized Bullfrog Spas Dealer). If your spa's pad is slightly sloped it will not affect the performance of the spa or its structure, however, there should be no dips, sags, or unevenness in the pad. Most patios are built to slope away from the house for drainage purposes. There should be no more than a 1/2" (1cm) slope in an 8 ft (2m) run. Recommended flooring materials include a concrete pad, concrete pavers or bricks, pea gravel, or crushed rock 1.5" (4cm) or less, or a reinforced deck. Additionally, your authorized Bullfrog Spas Dealer should sell or recommend pre-formed spa pads.

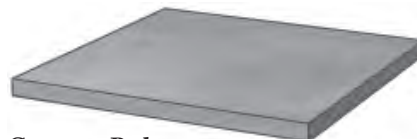

Concrete Pad



Concrete Pavers

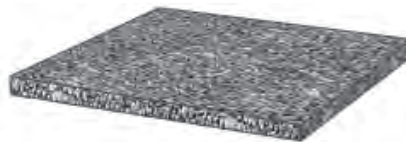

Pea Gravel or Crushed Rock

NOTE: Concrete foundations should be a minimum of 4 inches (10cm) thick and should be reinforced with either rebar or mesh. For electrical grounding purposes, the rebar or mesh should be attached to a bond wire (see Electrical Requirements and Installation Instructions).

▲WARNING: To prevent serious damage to your spa, it is important that the spa foundation be supported by a flat, stable,

and consistent subsurface. Bullfrog Spas International highly recommends consulting a qualified, licensed Contractor prior to the installation of any spa foundation. For assistance, contact your authorized Bullfrog Spas Dealer.

**▲WARNING:** Because your spa pad must provide continuous support for the entire base of the spa, you should never level it with shims. If it is necessary to level your spa, make sure the entire spa's structure is fully supported, both in the center as well as the outer edge. When leveling your spa, there should be no voids beneath it. Contact your authorized Bullfrog Spas Dealer before making any leveling adjustments. Structural damage to the spa resulting from incorrect installation, placement on an inadequate foundation, or improper leveling will void the spa's warranty.

**Elevated Installations:** Be certain your deck or elevated structure can support the maximum filled weight of your spa along with the total weight of occupants that use it. You must know the deck's weight-bearing load capacity and ensure that it is greater than the maximum filled weight of your spa combined with the occupants using it or serious injury or structural damage could result. To find the weight bearing load requirement along with the maximum filled weight of your spa, refer to the Spa Technical Specifications Chart or contact an authorized Bullfrog Spas Dealer.

**▲CAUTION:** Consult a qualified Structural Engineer or Contractor before the spa is placed on an elevated structure or deck.

### Design Considerations

**Hard-Surface Options (Decking and Flooring):** In addition to selecting a hard surface that meets the recommended safety and maintenance criteria, consider textures and colors that will assist in enhancing the aesthetics of the area in which your spa will be installed. The decision to match, contrast, or blend the hard surface colors and textures with those of your spa should only be made after carefully researching your options. The cost of a Landscape Architect may be money well spent.

**Surrounding Landscape:** The correct landscape around your spa will not only soften the adjacent hard surface areas, but will add life and much enjoyment to the environment. If the budget allows, you may want to consult with a Landscape Architect for expert advice.

**Spa-Side Accessories:** Besides selecting the correct hard surfaces and landscape around your spa, the addition of the proper spa-side accessories will provide just the finishing touch that you are looking for. Spa steps, benches, towel racks, planter boxes, or an outdoor fireplace are just a few of the items that can be considered when accessorizing your spa.



## Delivery Basics

To prepare for the delivery of your spa, make sure the delivery path is clear and no obstructions are present. Obstacles such as overhanging tree limbs, awnings, protruding gas meters, water meters, and A/C units can prevent easy access. It may be necessary to remove a gate, part of a fence, or other items in order to dolly the spa to the desired location. If there are more than six consecutive stairs without a landing, you may be required to find another delivery path. Check the measurements on 90° turns to make sure the spa will fit through. Occasionally a crane is required to install the spa by lifting it to its final destination. This occurs when the spa has to be taken off of the dolly cart to go over a wall, either because the entry area is too narrow, the eaves are too low, the corner is too tight, or the stairway is too steep. The use of a crane is a common practice and is usually the easiest and safest method for moving a spa when access is difficult. The crane has a truck-mounted boom and can fit easily in your driveway. The Crane Operator will lift your spa over walls, buildings, or

any other obstruction and place it as close to the installation site as possible.

Depending on access to the spa site, your spa may be dollyed in either horizontal or vertical position. For your convenience, the following charts provide the dimensions of your spa in either the horizontal or vertical position.

**NOTE:** The height of the cart used to dolly your spa into position will need to be added to the height of your spa when calculating the total height clearance required to complete your delivery. Spa carts are typically around 6 inches (15cm) in height. (If necessary, see your authorized Bullfrog Spas Dealer for the exact height.)

**▲WARNING:** An empty spa (spa without water in it) must not be left exposed to sunlight as shell damage may occur. Once the spa is unwrapped, fill spa with water immediately or shade the spa with cover or wrapping to prevent direct exposure to sunlight.

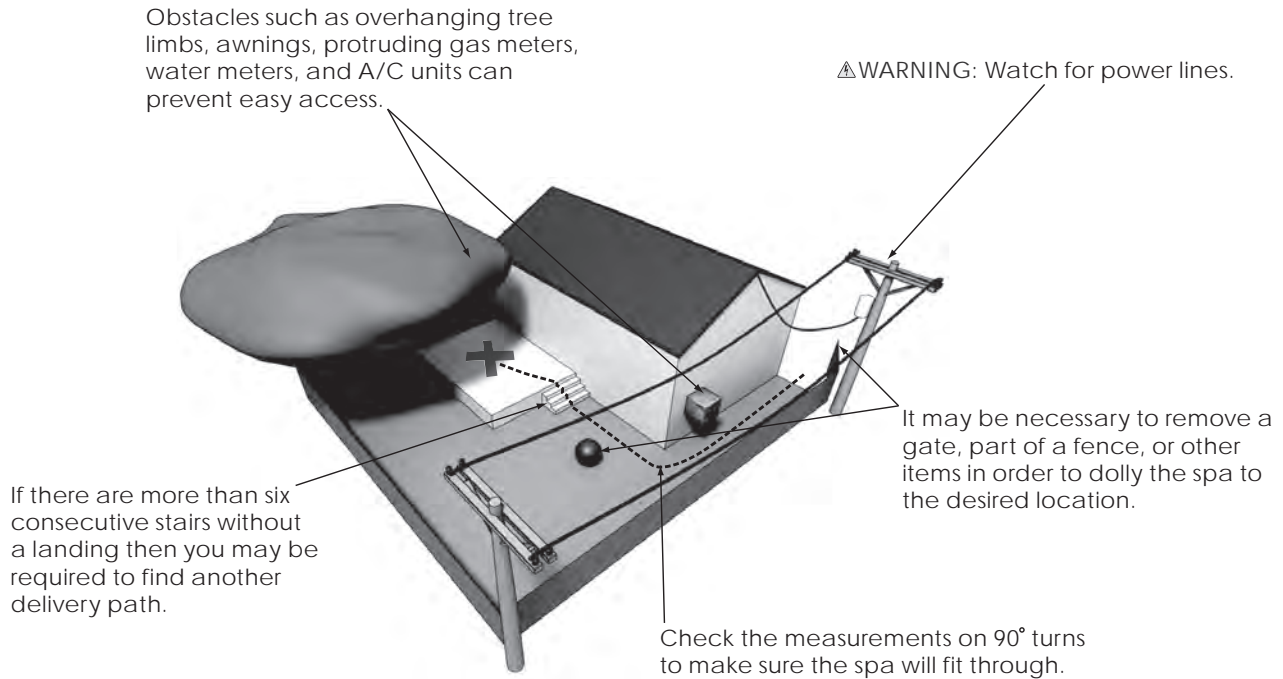

## Spa Dimensions Chart

Model	Width	Length	Height
Series I 331	5'6" (1.68m)	6'10" (2.08m)	31" (.79m)
Series I 451	6'7" (2.01m)	7'4" (2.24m)	36" (.91m)
Series I 462	7'4" (2.24m)	7'4" (2.24m)	36" (.91m)
Series I 562	7'4" (2.24m)	7'4" (2.24m)	36" (.91m)
Series I 552	7'10" (2.39m)	7'10" (2.39m)	36" (.91m)
Series I 662	7'10" (2.39m)	7'10" (2.39m)	36" (.91m)
Series I 682	7'10" (2.39m)	7'10" (2.39m)	36" (.91m)
Series II 231	5'6" (1.68m)	6'10" (2.08m)	31" (.79m)
Series II 251	6'7" (2.01m)	7'4" (2.24m)	36" (.91m)
Series II 362	7'4" (2.24m)	7'4" (2.24m)	36" (.91m)
SportX 131	5'6" (1.68m)	6'10" (2.08m)	31" (.79m)
SportX 151	6'7" (2.01m)	7'4" (2.24m)	36" (.91m)
SportX 162	7'4" (2.24m)	7'4" (2.24m)	36" (.91m)

Corner radius for all models is 15.5" (0.3937m)

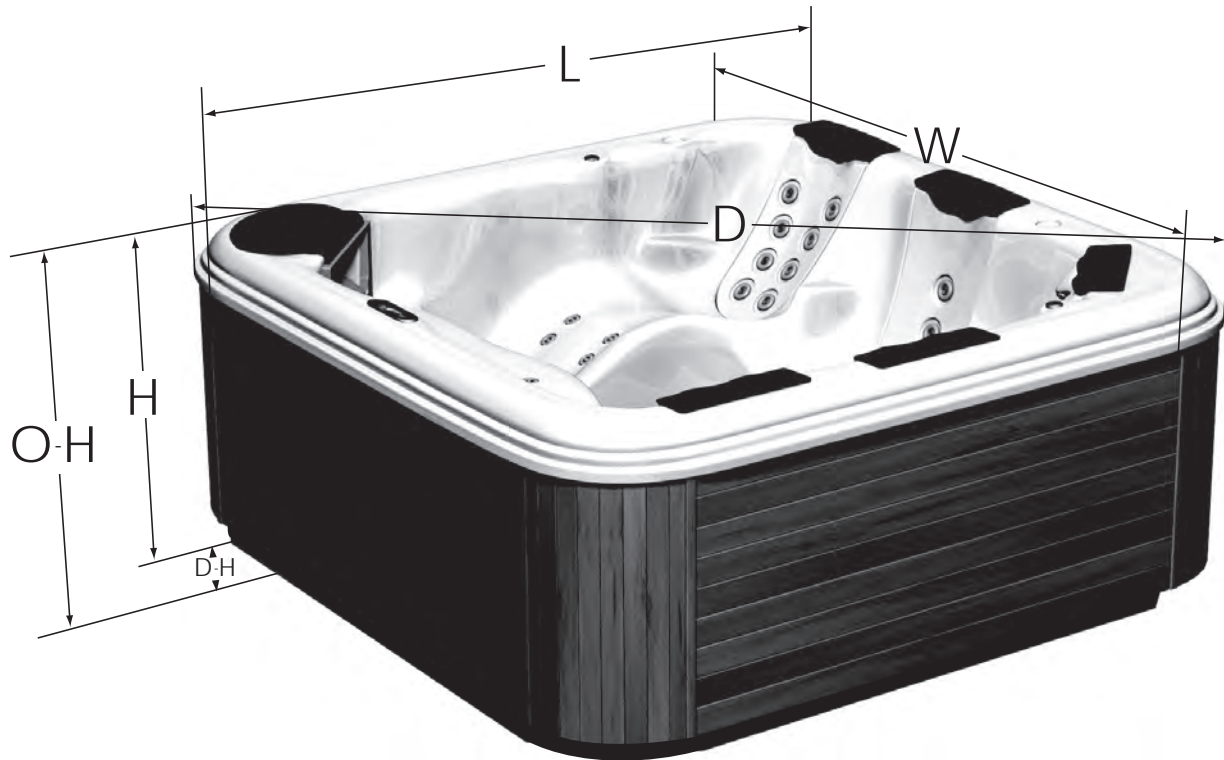

# Electrical Chaseways

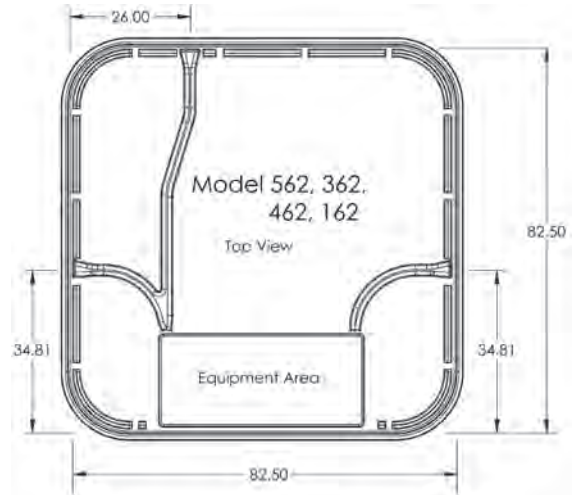
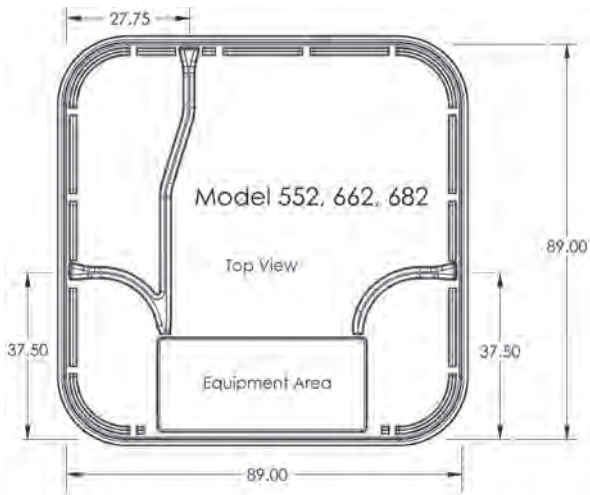
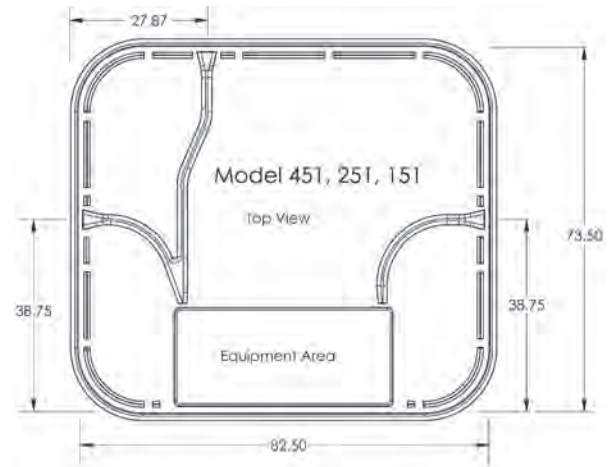
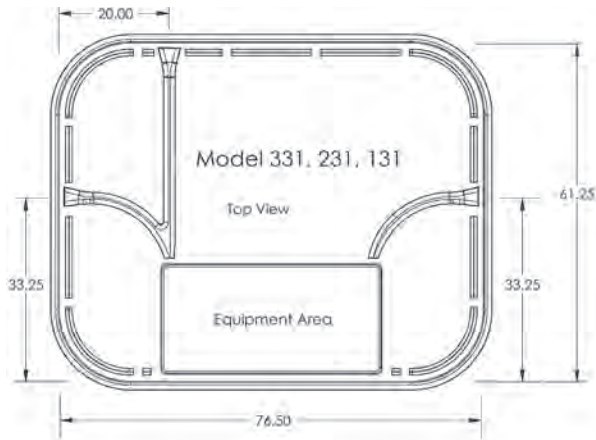

## Drilling Conduit Hole:

All dimensions are at the bottom base.

1" (2.54cm) Conduit Drill 1-3/8" (3.49cm) hole

3/4" (1.91cm) Conduit Drill 1-1/8" (2.86cm) hole

Center of hole is 1" (2.54cm) from the ground



## Electrical Requirements and Installation Instructions

IMPORTANT: Provide a copy of these instructions to your Electrician.

The installation of all spas must be in accordance with national and local wiring rules. Always have a licensed Electrician perform the electrical installation. Each Bullfrog Spa is manufactured and tested to a standard that provides maximum protection against electrical shock. Improper wiring may prevent the spa from operating safely which could result in electrical shock, injury or death. Improper wiring could also lead to a malfunction of the spa's equipment and risk of fire.

### Important Technical Information

**Voltage Definitions:** When reading these instructions, the term 120V~ refers to the 110-120V~ range of voltage, while the 240V~ term refers to the 220-240 range of voltage.

**Wiring Connection:** Appliance must be permanently connected to fixed wiring (except for U.S./CAN 120V~/60Hz Cord-Connected units).

**Wiring Diagrams:** In addition to the instructions that follow, please reference the appropriate Wiring Diagrams (120V~/60Hz Cord-Connected, 120V~/60Hz Permanently-Connected, 240V~/60Hz Permanently-Connected, or 240V~/50Hz Permanently-Connected).

**Electrical Service Wire Size and Type:** The size of wire required to supply the spa with power is dependent upon the length of the electrical run and should only be determined by a licensed Electrician. Installation must be in accordance with all national and local wiring rules. All wiring must be copper to ensure adequate connections. Never use aluminum wire.

### Spa Location:

- **Overhead Power Lines:** Based upon the national and local wiring rules that apply to your area, you will need to install your spa at the required minimum horizontal and vertical distances from all power lines.
- **Service Disconnect:** Based upon your area, a disconnect device must be incorporated into the fixed wiring in accordance with national and local wiring rules. If the national and local wiring rules permit, a GFCI Sub-Panel may be used to substitute the service disconnect, providing that it is located within the same parameters.

- **Electrical Outlets, Switches and Devices:** Based upon the national and local wiring rules that apply to your area, you must install your spa at or beyond the required minimum distance from all electrical outlets, switches, and devices.
- **Bonding:** Based upon the national and local wiring rules that apply to your area, the Control System Box located inside the equipment compartment of your spa must be bonded to all metal equipment, handrails, fixtures, enclosures, pipe, or conduit that are located within the maximum specified distances. The bonding is to be connected to the ground lug connector on the exterior surface of the Control System Box and all metal items previously described.
- **Equipment Compartment Access:** Make sure the spa is positioned so that access to the equipment compartment will not be blocked.

**Ground Fault Circuit Interrupters (GFCI):** As per national and local wiring rules, all spas, hot tubs, and associated electrical components must be protected by a GFCI, either at the main breaker box or at the service disconnect.

**▲WARNING:** Removal or bypassing the GFCI will result in an unsafe spa and will void your spa's warranty. When installing the GFCI, all conductors except the green ground must be routed through the GFCI, including the neutral. Never bypass the neutral line. If the neutral line is bypassed, then the current will be imbalanced and cause the GFCI to trip. See GFCI Wiring Diagrams or contact Bullfrog International, LC or your authorized Bullfrog Spa dealer. **REQUIRED TEST PROCEDURE:** After the spa is first filled and turned on, and prior to each use, the GFCI should be tested as follows:  
**Step 1:** Press **test** on the GFCI breaker. The spa should stop operating.

**Step 2:** After 30 seconds, press **reset** and then verify that power has been restored to the spa. If the GFCI fails to operate in this manner you may have an electrical malfunction and be at risk of electrical shock. Should this occur, turn off the GFCI breaker to the spa and do not use the spa until the malfunction has been repaired by a licensed Electrician or your authorized Bullfrog Spa dealer.

**Dedicated Electrical Circuit Breaker:** The electrical service to the spa must include a suitably rated switch or circuit breaker. Whether the spa is a 120V~/60Hz Cord-Connected spa or a 120V~/60Hz, 240V~/60Hz or 230V~/50Hz Permanently-Connected spa, it is required that the circuit breaker that supplies power to the spa is dedicated and does not supply power to any other electrical outlet, device or item.

**Electrical Access Conduit:** Each Bullfrog Spa is manufactured with three electrical access chaseways in its base to allow conduit to be run to the spas control system. These chaseways are marked by stickers indicating access points.

**12V Maximum on Live Parts:** Live parts accessible to the user must not exceed 12V.

**240V~/60Hz 30A Conversion Option:** If there is not 50A of electrical service available, an authorized Bullfrog Spa dealer or Electrician can easily convert the spa to operate on 30A (conversion instructions are located inside the Control System Box). Please be aware, spas converted to 30A are only capable of heating the water when pump 1 is in low-speed, not high-speed. This heating limitation is acceptable in most climates as well as indoor installations.

**230V~/50Hz, 32A Conversion Options:** If there is not 32A of electrical service available, an authorized Bullfrog Spa dealer or an Electrician can easily convert the spa to operate on either a single or dual 16A x2 service. Conversion instructions for the following configurations are located inside the Control System Box of the spa.

**230V~/50Hz 16A Single Service:** Please be aware, spas converted to 16A are only capable of heating the water when the circulation pump is in low-speed, not high-speed. This heating limitation is acceptable in most climates as well as indoor installations.

**230V~/50Hz 16A, 16A Dual Service:** Operation of spa is identical to single 32A service except that service is divided into two separate 16A services.

**400V~3N 16A x 3, 50Hz Service:** Operation of spa is identical to 32A service is divided into 3 separate 240V~ service with one shared neutral.

**New Installations and Re-Installations:** These instructions apply to both new installations and re-installations which may occur when a spa is moved or relocated to a new location.

### **120V~/60Hz or 240V~/60Hz Convertible Equipment (Model BF15-All U.S./CAN Single-Pump Spas only)**

Single-Pump spas may be equipped with voltage convertible equipment (Model BF15). Depending upon pump installed, the BF03 equipment allows the spa to operate either on a 120V~/60Hz or 240V~/60Hz electrical service.

**120V~/60Hz Pump:** Spas equipped with a 120V~/60Hz pump can be 120V~/60Hz Cord-Connected, 120V~/60Hz

Permanently-Connected, or 240V~/60Hz Permanently-Connected.

**120V~/60Hz Cord-Connected Installation:** This option is only applicable if the spa was ordered from the factory with both a 120V~/60Hz pump and a 120V~/60Hz power cord. The spa's Safety Approval Listing and warranty will be void, and the spa may be unsafe if an aftermarket power cord is installed on the spa. Cord-Connected spas have already been converted to operate on 120V~/60Hz power at the factory and come with approximately 15' (4.57m) of useable power cord (the maximum length allowed) attached to the spa. This factory installed power cord comes with a built-in GFCI breaker.

**IMPORTANT:** Cordage shall be replaced only with a special cordage assembly available from the manufacturer, its service agent, or similarly qualified persons in order to avoid a hazard.

Cord-Connected 120V~/60Hz spas require that the factory installed power cord, with its built-in GFCI breaker be connected to a 120V~/60Hz, 20A, Single-Phase, dedicated, grounded circuit and power outlet. It is important that this circuit is dedicated (not being used by any other electrical appliance) or your spa may not function properly. For safety purposes, the location of the power outlet (where the spa is to be connected) can be no closer than the minimum allowable distance specified by the national and local wiring rules in your area. Installation must be in accordance with all national and local wiring rules.

**Fill Spa before Powering on:** Always fill the spa to the recommended level before turning on the power (see Pre-fill Checklist).

**Residual Current Device:** The appliance should be supplied through a residual current device with a rated tripping current not exceeding 30mA.

**▲WARNING:** Never use an extension cord. Bullfrog International, LC does not allow the use of an extension cord under any possible situation. The use of an extension cord voids any warranty on the spa equipment and also exposes the consumer to additional risk of fire, electrical shock, injury, or death.

**120V~/60Hz Permanently-Connected Installation:** Unless your spa was ordered from the factory with a 120V~/60Hz power cord, its equipment is configured to operate on 240V~/60Hz power (even though it was equipped with a 120V~/60Hz pump). Prior to the 120V~/60Hz electrical installation, the spa's equipment will need to be converted from its 240V~/60Hz

configuration to a 120V~/60Hz configuration. For specific conversion instructions, please refer to the system wiring diagram inside the Control System Box (located in the spa's equipment compartment).

Permanently-Connected 120V~/60Hz spas require a GFCI protected, 3-wire (Line 1, Neutral and Ground), 120V~/60Hz, 20A, Single-Phase, dedicated electrical circuit. It is important that this circuit is dedicated (not being used by any other electrical appliance) or the spa may not function properly. Installation must be in accordance with all national and local wiring rules.

**240V~/60Hz Permanently-Connected Installation:** Even though the spa is equipped with a 120V~/60Hz pump, it has already been configured to operate on 240V~/60Hz power unless the spa came with a factory connected 120V~/60Hz power cord, in which case the spa's equipment will need to be converted from its 120V~/60Hz configuration to the 240V~/60Hz configuration. For specific conversion instructions, please refer to the system wiring diagram inside the Control System Box (located in the spa's equipment compartment).

Permanently-Connected 240V~/60Hz spas require a GFCI protected, 4-wire (Line 1, Line 2, Neutral, and Ground), 240V~/60Hz, 50A, Single-Phase, dedicated electrical circuit. It is important that this circuit is dedicated (not being used by any other electrical appliance) or the spa may not function properly. Installation must be in accordance with all national and local wiring rules.

**240V~/60Hz Pump:** Spas equipped with a 240V~/60Hz pump can only be Permanently-Connected. **240V~/60Hz Permanently-Connected Installation:** Your spa has been configured to operate only on 240V~/60Hz power.

Permanently-Connected 240V~/60Hz spas requires a GFCI protected, 4-wire (Line 1, Line 2, Neutral and Ground), 240V~/60Hz, 50A, Single-Phase, dedicated electrical circuit. It is important that this circuit is dedicated (not being used by any other electrical appliance) or the spa may not function properly. Installation must be in accordance with all national and local wiring rules.

**240V~/60Hz Equipment (Model BF15-U.S./CAN Dual-Pump Spas)** All spas not listed as voltage convertible are equipped with (model BF05) 240V~/60Hz equipment. This equipment only operates on a 240V~/60Hz electrical service.

Permanently-Connected 240V~/60Hz spas require a GFCI protected, 4-wire (Line 1, Line 2, Neutral and Ground),

240V~/60Hz, 50A, Single-Phase, dedicated electrical circuit.

It is required that this circuit is dedicated (not being used by any other electrical appliance) or the spa may not function properly. Installation must be in accordance with all national and local wiring rules.

**230V~/50Hz EQUIPMENT (Model BF04-All European Spas)** Spas are equipped with 230V~/50Hz pumps and 240V~/50Hz equipment (Model BF04). This 230V~/50Hz equipment allows the spa to operate only on a 230V~/50Hz electrical service.

Permanently-Connected 230V~/50Hz, 32A spas require a GFCI protected, 240V~/50Hz, 32A Single-Service, 16A Single-Service, or 16A – 16A Dual-Service 400V~, 3N, 16Ax3, 50Hz, dedicated electrical circuit. It is important that this circuit is dedicated (not being used by any other electrical appliance) or the spa may not function properly. For specific conversion instructions, please refer to the system wiring diagram inside the Control System Box (located in the spa's equipment compartment). Installation must be in accordance with all national and local wiring rules.

### Connecting the electrical service to the spa

**IMPORTANT:** Installation must be in accordance with all national and local wiring rules and performed by a licensed Electrician.

**Step 1:** Choose one of the three available conduit entry points. (Yellow decal)

**Step 2:** Determine the conduit diameter and drill a hole that is properly sized for the conduit ( $\frac{3}{4}$ " conduit drill 1- $\frac{1}{8}$ " hole, 1" conduit drill 1- $\frac{3}{8}$ " hole). Use the + as the locator for the center of the hole. The hole saw must go through two layers of plastic. There is a 1" space between both layers.

**Step 3:** Push the conduit through the hole until it comes out into the equipment area.

**Step 4:** Remove the faceplate to the Control System Box

**Step 5:** Connect the conduit to the Control System Box using a Liquid Tight Connector.

**Step 6:** Run the required wires through the conduit to the Control System Box.

**Step 7:** Connect the electrical service wires to the terminal block located in the Control System Box.

**Step 8:** Replace the Control System Box faceplate and the equipment compartment door. The electrical hook-up is complete.

**Ratings:**  
120/240V~,60 Hz, 16/40A  
240V~,60Hz,24/40A

**Number of Supply Wires:** 2/3 + Ground  
3 + Ground

**Circuit Protection:**  
20/50A  
30/50A

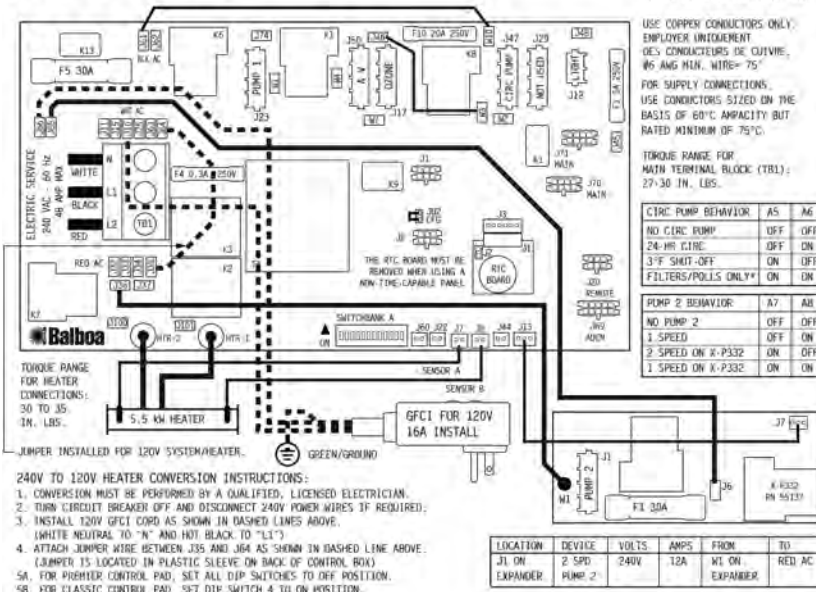

CONNECT ONLY TO CIRCUITS PROTECTED BY A CLASS A GFCI.  
A DISCONNECTING MEANS MUST BE INSTALLED WITHIN SIGHT FROM THE EQUIPMENT AND AT LEAST 5 FEET (1.52 M) FROM THE INSIDE WALLS OF THE POOL, SPA, OR HOT TUB.

USE COPPER CONDUCTORS ONLY!  
EMPLOYER REQUIREMENT  
OES CONDUCTORS OR CUIVIM,  
#6 AWG MIN. WIRE= 75°  
FOR SUPPLY CONNECTIONS.  
USE CONDUCTORS SIZED ON THE BASIS OF 60°C AMPACITY BUT RATED MINIMUM OF 75°C.

TORQUE RANGE FOR MAIN TERMINAL BLOCK (TR1):  
27-30 IN. LBS.

CIRC. PUMP BEHAVIOR	A5	A6
NO CIRC. PUMP	OFF	OFF
24-HR CIRC	OFF	ON
3°F SHUT-OFF	ON	OFF
FILTERS/POLLS ONLY*	ON	ON

PUMP 2 BEHAVIOR	A7	A8
NO PUMP 2	OFF	OFF
1 SPEED	OFF	ON
2 SPEED ON X-P332	ON	OFF
1 SPEED ON X-P332	ON	ON

LOCATION	DEVICE	VOLTS	AMPS	FROM	TO
J11 ON EXPANDER	2 SPD PUMP 2	240V	12A	W1 ON EXPANDER	RED AC

JR2 ON 2 PINS

SWITCHBANK A OFF (DOWN)	SWITCHBANK A ON (UP)
TEST MODE OFF	A1 TEST MODE ON
SEE AMPERAGE SELECT	A2 SEE AMPERAGE SELECT
SEE AMPERAGE SELECT	A3 SEE AMPERAGE SELECT
FILTER BY TIME	A4 FILTER BY DURATION
SEE CIRC. PUMP BEHAVIOR	A5 SEE CIRC. PUMP BEHAVIOR
SEE CIRC. PUMP BEHAVIOR	A6 SEE CIRC. PUMP BEHAVIOR
SEE PUMP 2 BEHAVIOR	A7 SEE PUMP 2 BEHAVIOR
SEE PUMP 2 BEHAVIOR	A8 SEE PUMP 2 BEHAVIOR
FILTER CYCLE FOR 2 HOURS	A9 FILTER CYCLE FOR 3 HOURS
NO EDIT MENU	A10 EDIT MENU
NO SPECIAL AMPERAGE RULE	A11 SPECIAL AMPERAGE RULE
STORE SETTINGS	A12 MEMORY RESET

ALL UNUSED SWITCHES SHOULD BE OFF

AMPERAGE SELECT		
# OF HIGH-SPEED PUMPS AND/OR BLOWER WITH HEATER	A2	A3
0 HIGH-SPEED PUMP OR BLOWER	OFF	OFF
1 HIGH-SPEED PUMP OR BLOWER	ON	OFF
2 HIGH-SPEED PUMPS OR 1 HIGH-SPEED PUMP AND BLOWER	OFF	ON
3 HIGH-SPEED PUMPS OR 2 HIGH-SPEED PUMPS AND BLOWER	ON	ON

LOCATION	DEVICE	VOLTS	AMPS	FROM	TO
J23	2 SPD P1	240V	12A	W1	RED AC
J17	OZONE	120V	1A	W7	WHT AC
J50	A V	120V	2A	W4	WHT AC
J47	CIRC. PUMP*	120V	4A	W2	WHT AC
J29	NOT USED	120V		W2	WHT AC
J12	SPA LIGHT	12V	12W		
HTR	HEATER	240V	5.5kW	HTR TERM	HTR 1/2

\*CIRC. PUMP IS AN OPTIONAL DEVICE. SEE CIRC. PUMP BEHAVIOR TABLE.

TOTAL OUTPUT AMP DRAW NOT TO EXCEED MAX INPUT RATING OF SPA  
USE EARTH GROUND CONNECTIONS AS INDICATED INSIDE THE SYSTEM ENCLOSURE

## To Convert Spa to 120V Operation

(Requires 120V Pump)

Step 1: Turn power off to spa.

Step 2: Attach jumper wire (from back of control box) between J11 (above main terminal block)

Step 3: Turn dip switches A2 and A3 to "off" (down) position.

Step 4: Turn dip switch A12 to "On" position, then turn on power to spa. Once "PR" appears on the control panel display, turn power back off. This sets system for 120V operation.

Step 5: Turn dip switch A12 to "off" position, then power up spa for normal start up.

NOTE: This conversion must be performed by an authorized Bullfrog Spas Dealer.

# GFCI Wiring Diagrams

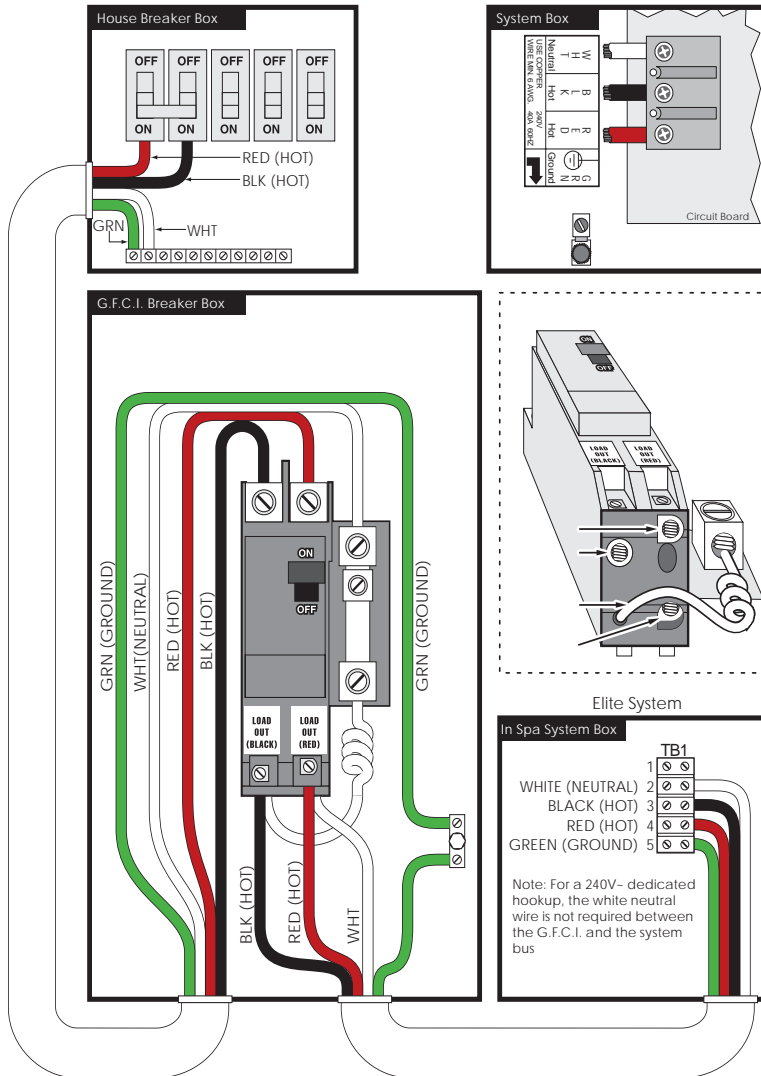

60Hz Install (typical) U.S./CAN

IMPORTANT: Installation must be in accordance with all national and local wiring rules and performed by a licensed Electrician.

# BFG15 Wiring Diagram (Europe/Australia)



BFG15 — PN 55556-01

04/29/09

ML (MAIN PANELS)  
J70, J71

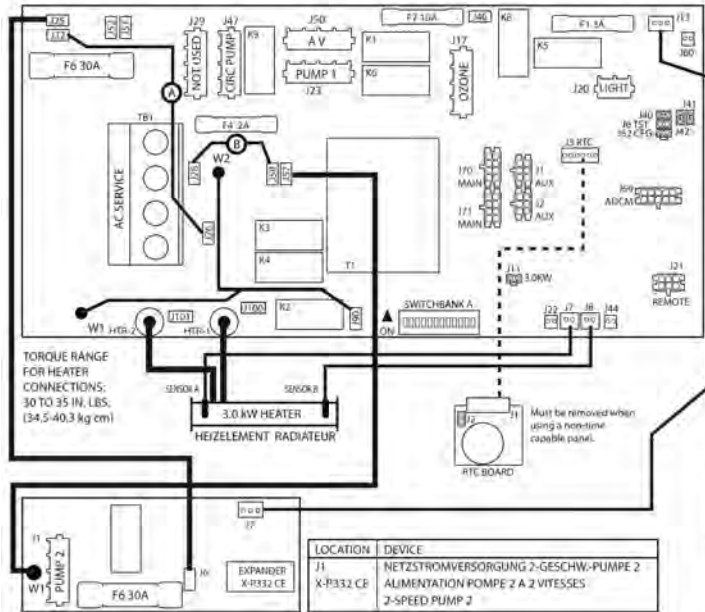

USE COPPER CONDUCTORS ONLY.  
EMPLOYER UNIQUEMENT  
DES CONDUCTEURS DE CUIVRE.

FOR SUPPLY CONNECTIONS,  
USE CONDUCTORS SIZED ON THE  
BASIS OF 60°C AMPACITY BUT  
RATED MINIMUM OF 75°C.

TORQUE RANGE FOR  
MAIN TERMINAL BLOCK (TB1):  
27-30 IN. LBS.  
(31.1-34.5 kg cm)

GROUND - TERRE - ERDE  
GELB/GRÜN - JAUNE/VERT  
YELLOW/GREEN

SWITCHBANK A OFF (DOWN)

J82 ON 2 PINS



SWITCHBANK A ON (UP)

TEST MODE OFF	A1	TEST MODE ON
SEE AMPERAGE SELECT	A2	SEE AMPERAGE SELECT
SEE AMPERAGE SELECT	A3	SEE AMPERAGE SELECT
FILTER BY TIME	A4	FILTER BY DURATION
SEE CIRC PUMP BEHAVIOR	A5	SEE CIRC PUMP BEHAVIOR
SEE CIRC PUMP BEHAVIOR	A6	SEE CIRC PUMP BEHAVIOR
SEE PUMP 2 BEHAVIOR	A7	SEE PUMP 2 BEHAVIOR
SEE PUMP 2 BEHAVIOR	A8	SEE PUMP 2 BEHAVIOR
FILTER CYCLE FOR 2 HOURS	A9	FILTER CYCLE FOR 3 HOURS
NO EDIT MENU	A10	EDIT MENU
NO SPECIAL AMPERAGE RULE	A11	SPECIAL AMPERAGE RULE
STORE SETTINGS	A12	MEMORY RESET

ALL UNUSED SWITCHES SHOULD BE OFF

CIRC PUMP BEHAVIOR	A5	A6
NO CIRC PUMP	OFF	OFF
24-HR CIRC	OFF	ON
3°F SHUT-OFF	ON	OFF
FILTERS/POLLS ONLY*	ON	ON

PUMP 2 BEHAVIOR	A7	A8
NO PUMP 2	OFF	OFF
1 SPEED	OFF	ON
2 SPEED ON X-P332	ON	OFF
1 SPEED ON X-P332	ON	ON

AMPERAGE SELECT		
# OF HIGH-SPEED PUMPS AND/OR BLOWER WITH HEATER	A2	A3
0 HIGH-SPEED PUMP OR BLOWER	OFF	OFF
1 HIGH-SPEED PUMP OR BLOWER	ON	OFF
2 HIGH-SPEED PUMPS OR 1 HIGH-SPEED PUMP AND BLOWER	OFF	ON
3 HIGH-SPEED PUMPS OR 2 HIGH-SPEED PUMPS AND BLOWER	ON	ON

AC SERVICE	WIRE (A) (HT)	WIRE (B) (LUE)
230V 1p / 1x16A-32A	J26 TO J23	J58 TO J28
230V 1p / 2x16A	REMOVE	J58 TO J28
400V 3p / 3x16A	REMOVE	REMOVE

LOCATION	DEVICE
J23	NETZSTROMVERSORGUNG 2-GESCHW.-PUMPE 1 ALIMENTATION POMPE 1 A 2 VITESSES 2-SPEED PUMP 1
J29	NOT USED
J47	KREISLAUF PUMPE POMPE DE CIRCULATION CIRC PUMP
J50	A V
J17	OZONGENERATOR GENERATOR OZONE OZONE GENERATOR
J20	BELEUCHTUNG ECLAIRAGE BAIN HYDRO SPA LIGHT

## Ratings:

230V~, 50Hz, 16/32A,

230V~, 50Hz, 16A x 2

400V~, 50Hz, 3N, 16Ax3

# Bullfrog Spas & Yard™ Stereo Door Wiring Diagram

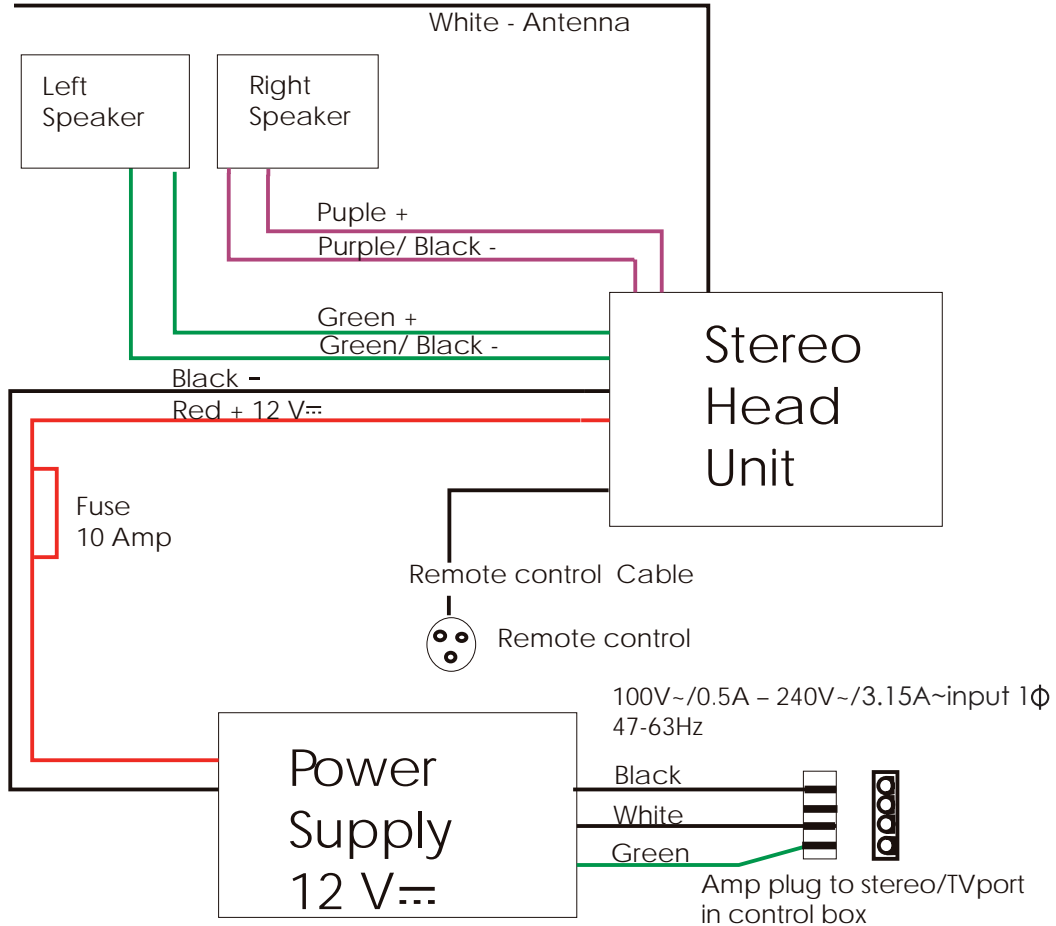

## Ratings:

Europe/Australia: 220-240V~ 3.15A 50Hz

Output: 12V 5A

US/CAN: 100-127V~, 3.15A 60Hz

# IPX5

## Diagnostic Message (for all control systems)

Message	Meaning	Action Required
	No message on display. Power has been cut off to the spa.	The control panel will be disabled until power returns. Spa settings are preserved until the next power-up.
<b>OHH</b>	<b>Overheat</b> - The spa has shut down. One of the sensors has detected that the spa water is 118°F (47.8°C) at the heater.	<b>DO NOT ENTER THE WATER.</b> Remove the spa cover and allow water to cool. Once the heater has cooled, reset by pushing any button. If spa does not reset, shut off the power to the spa and contact your authorized Bullfrog Spas Dealer.
<b>OHS</b>	<b>Overheat</b> - The spa has shut down. One of the sensors has detected that the spa water is 110°F (43.3°C).	<b>DO NOT ENTER THE WATER.</b> Remove the spa cover and allow water to cool. At 107°F (41.7°C), the spa should automatically reset. If spa does not reset, shut off the power to the spa and contact your authorized Bullfrog Spas Dealer.
<b>ICE</b>	Ice – Potential freeze conditions detected.	No action is required. The pumps will automatically activate regardless of spa status.
<b>SnA</b>	Spa has shutdown.	The sensor plugged into sensor "A" jack is not working. The error may appear temporarily in an overheat situation and disappear once the heater cools. If the problem persists, contact your authorized Bullfrog Spas Dealer.
<b>SnB</b>	Spa has shutdown.	The sensor plugged into sensor "B" jack is not working. The error may appear temporarily in an overheat situation and disappear once the heater cools. If the problem persists, contact your authorized Bullfrog Spas Dealer.
<b>SnS</b>	Spa has shutdown.	Sensors are out of balance. If this is alternating with the temperature, it may just be temporary. If the problem persists, contact your authorized Bullfrog Spas Dealer.
<b>HFL</b>	A difference between the temperature sensors was detected.	This could indicate a flow problem. Check water level in spa. Refill if necessary. If the water level is acceptable, make sure the pumps have been primed. If the problem persists, contact your authorized Bullfrog Spas Dealer.
<b>LF</b>	Heater is shut down, but other spa functions run normally (displays on the 5 <sup>th</sup> occurrence of the <b>HFL</b> message within a 24-hour period).	Persistent low flow problems. Follow the instructions for the <b>HFL</b> message. Heating capacity of the spa will not reset automatically. Press any button to reset.
<b>dr</b>	No message on display. Power has been cut off to the spa.	Check water level in spa. Refill if necessary. If the water level is okay, make sure the pumps have been primed. Press any button to reset.
<b>dr4</b>	Inadequate water detected in heater.	Inadequate water detected in the heater. Follow the actions listed for the <b>dr</b> message. The spa will not reset automatically. Press any button to reset.
<b>Pr</b>	When your spa is first actuated, it will go into Priming mode.	The Priming mode will last for up to 4 minutes and then the spa will begin to heat and maintain the water temperature in the Standard mode.
<b>--F</b> <b>--C</b>	Temperature not yet known.	This is normal within the first few minutes of the spa power up.
<b>- - -</b>	Temperature not yet known.	This is normal within the first few minutes of the spa power up.
<b>bUF</b>	Internal problem detected.	Repair required. Contact your authorized dealer or service organization.



Message	Meaning	Action Required
<i>Std</i>	The spa is operating in Standard mode.	Temperature display is current after pump has been running for at least 2 minutes. Press <b>temp</b> followed by <b>light</b> to switch modes.
<i>Ecn</i>	The spa is operating in Economy mode.	<b>Ecn</b> will appear solid on the display when the temperature is not current. <b>Ecn</b> will alternate with the temperature when the temperature is current. Press <b>temp</b> followed by <b>light</b> to switch modes.
<i>SE</i>	The spa is operating Standard-in-Economy mode.	Operates the same as Standard mode; however it will revert to Economy mode after 1 hour. Press <b>temp</b> + <b>light</b> to switch directly to Economy mode.
<i>SLP</i>	The spa is in Sleep mode.	Press <b>temp</b> + <b>light</b> to switch modes.
<i>Sby</i>	The spa is in Standby mode.	Press any button to exit mode and return to normal operation.

**Periodic Reminder Messages** (On Premier Control Panel, press **mode/prog** to reset a displayed reminder. On Basic Control Panels, press **temp** + **light** to reset a displayed reminder.)

Message	Meaning	Action Required
<i>rPH</i>	Every 7 days	Test and adjust chemical levels per manufacturer's instructions.
<i>rSA</i>	Every 7 days	Test and adjust chemical levels per manufacturer's instructions.
<i>rCL</i>	Every 30 days	Remove, clean, and reinstall filter per manufacturer's instructions.
<i>rES</i>	Every 30 days	Test and reset GFCI per manufacturer's instructions.
<i>rdr</i>	Every 90 days	Drain and refill spa per manufacturer's instructions.
<i>rCO</i>	Every 180 days	Clean and condition cover per manufacturer's instructions.
<i>rCR</i>	Every 180 days	Clean and condition cabinet per manufacturer's instructions.
<i>rCH</i>	Every 365 days	Install new filter.

**⚠WARNING! SHOCK HAZARD! No User Serviceable Parts.** Do not attempt service of this control system. Contact your authorized Bullfrog Spas Dealer or service organization for assistance. Follow all power connection instructions listed in this manual. Installation must be performed by a licensed Electrician and all grounding connections must be properly installed.

## Troubleshooting Guide

This guide will assist in solving simple problems with the spa. If the problem cannot be solved using these procedures, contact your authorized Bullfrog Spas Dealer.

### Control panel displays an error message:

**Cause:** An error has occurred.

**Solution:** See Diagnostic Messages for specific errors.

### Control pad and spa equipment do not operate:

**Cause #1:** No electrical power to spa.

**Solution:** Turn on or reset the GFCI circuit breaker. If this does not solve the problem, have a qualified Electrician check the electrical service.

**Cause #2:** The 20 or 30A fuse, depending on the system, has blown.

**Solution:** Contact your authorized Bullfrog Spas Dealer.

### GFCI breaker trips repeatedly:

**Cause #1:** Improper wiring to spa or GFCI breaker is defective.

**Solution:** Consult with a qualified Electrician.

**Cause #2:** There is a defective component on the spa.

**Solution:** Contact your authorized Bullfrog Spas Dealer.

### Spa pump turns off during operation:

**Cause #1:** Automatic timer has completed its 30 or 120 minute cycle.

**Solution:** Turn on the pump.

**Cause #2:** Pump has overheated due to the vents on the equipment door being blocked.

**Solution:** Clear items away from vents.

**Cause #3:** The pump motor is defective.

**Solution:** Contact your authorized Bullfrog Spas Dealer.

### Spa will not heat:

**Cause #1:** Slice valve is partially or fully closed.

**Solution:** Open slice valve and secure with valve keeper.

**Cause #2:** Thermostat has been turned down.

**Solution:** Adjust thermostat to desired temperature.

**Cause #3:** High limit sensor has tripped.

**Solution:** Press any button to reset.

**Cause #4:** Heating system is defective.

**Solution:** Contact your authorized Bullfrog Spas Dealer.

### Standard Spa light does not work:

**Cause #1:** Light bulb has burned out.

**Solution:** Replace light bulb.

**Cause #2:** Lighting system is defective.

**Solution:** Contact your authorized Bullfrog Spas Dealer.

### Spa pump will not turn on, creates a burning smell while running, or makes excessive noise while running:

**Cause:** Pump motor is defective.

**Solution:** Contact your authorized Bullfrog Spas Dealer.

### Jets surge on and off:

**Cause:** Water level is too low.

**Solution:** Adjust water to the water level indication mark on the faceplate of the filter assembly.

### Jets are weaker than normal or do not work at all, but the pump is running:

**Cause #1:** Jet handle(s) are partially or fully closed.

**Solution:** Open jet handle(s).

**Cause #2:** Filter cartridge is dirty.

**Solution:** See Cleaning the Filter.

**Cause #3:** There is air trapped in the spa equipment or its face piping.

**Solution:** Open the air bleed valve on each pump's housing and allow air to bleed out of the system. Be sure to tighten each air bleed valve as soon as water starts to flow.

**Cause #4:** The suction fitting(s) are blocked.

**Solution:** Remove any debris that may be blocking the suction fitting(s).

**Cause #5:** The JetZone Divider™ is not installed (if applicable).

**Solution:** Re-install in the appropriate JetPak™.

NOTE: Running the spa without a JetZone Divider can cause serious damage to the pumps.

**Cause #6:** Slice valve is closed.

**Solution:** Open valve and secure with valve keeper.

## LIMITED WARRANTY - BULLFROG SPAS SERIES I & II

---

The Bullfrog Spa Limited Warranty is one of the best in its class. It is deductible-free so you won't have to pay to have warranty work done on your spa. The Bullfrog Warranty is also not prorated, meaning the warranty is as strong at the end of the term as it is in the beginning.

Bullfrog International, LC ("Bullfrog") extends warranty coverage solely to the end-user purchaser ("Owner") of any portable Bullfrog Spa manufactured on or after January 1, 2007 for 2007 and later models installed for residential use in the United States or Canada.

### Lifetime JetPak™ Plumbing Warranty

Bullfrog warrants the Bullfrog Spa JetPak™ Plumbing System not to leak for the life of the original retail purchaser of the spa. This warranty specifically covers leaks from all JetPak jet fittings and all JetPak plumbing. After three years from the spa purchase date, any defective JetPak components must be sent to Bullfrog for repair or replacement at no charge.

### Lifetime Shell Structure & UniFrame™ Warranty

Bullfrog warrants the Bullfrog Spa shell not to leak and the injection-molded cabinet frame against degradation for the life of the original retail purchaser of the spa. After six years from the original spa purchase date, the defective spa must be sent to Bullfrog for repair at no charge. This warranty specifically covers leaks from the spa shell.

### Six-Year Shell Surface Warranty

Bullfrog warrants the surface finish of the Bullfrog Spa not to crack, fade, wrinkle, blister, peel or delaminate for six years from the original spa purchase date. This warranty specifically covers the spa shell.

### Five-Year EternaWood™ Cabinet & UniBase™ Warranty

Bullfrog warrants the EternaWood™ cabinet sections and molded base of the Bullfrog Spa against degradation and cracking for five years from the original spa purchase date. This warranty specifically covers the cabinet corners, door and side panels, and the molded spa base. The cabinet corners, door and side panels are deemed Easily Removed Components, and when found defective, will be replaced free of charge at your authorized Bullfrog Spa Dealer or by sending the defective component(s) to Bullfrog.

### BlameFree™ Equipment Warranty

With the exception of intentional damage, Bullfrog unconditionally warrants the electrical and mechanical equipment (excluding the Spa&Yard™ Stereo System and the SpaMonitor™) of the Bullfrog Spa, along with its associated piping and fittings, against failure that would require repair or replacement for three years from the original spa purchase date. This warranty specifically covers the pump(s), heater, control system (including fuses), spa light (including bulb or interior LED light), ozone purifier (including microchip), jets, SnapCaps™, FilterCap™, other Bullfrog mechanical equipment, and leaks from any component or plumbing fitting located beneath the spa shell. Defective components that are easily removed from the spa, such as the spa lightbulb (or interior LED light), jet nozzles and other Bullfrog mechanical equipment that can be readily replaced by the customer and do not require specialized tools or knowledge or create personal safety issues, all of which are deemed Easily Removed Components, will be repaired or replaced free of charge at your authorized Bullfrog Spa Dealer.

### Other Warranties

- Bullfrog warrants the Bullfrog Spa JetPlates™, Spa&Yard Stereo System, SpaMonitor, and the exterior LED lighting system against defects in materials and workmanship for one year from the original spa purchase date. The LED lights and exterior sconces are deemed Easily Removed Components, and when found defective, will be replaced free of charge at your authorized Bullfrog Spa Dealer or by sending the defective component(s) to Bullfrog. Color availability on replacement and aftermarket JetPlates is guaranteed for a minimum of one year. (Color availability beyond one year is dependent upon market demand and availability of color to Bullfrog.)
- Bullfrog warrants the Bullfrog Spa pillows stainless steel jet faces, ventilation screen, and filter cartridge(s) against defects in materials and workmanship through time of delivery.
- Spa covers and all other spa accessories attached to the Bullfrog Portable Spa after date of manufacture are not covered by this limited warranty. Please refer to the manufacturer of such products for information regarding warranty coverage.

## Warranty Performance

Bullfrog or its authorized agent will repair or replace any malfunction or defective component on the Bullfrog Spa that is covered under the terms of this limited warranty and was purchased from an authorized Bullfrog spa dealer. In doing so, Bullfrog reserves the right, at its option, to either repair or replace the defective spa or component. If Bullfrog Spas International, determines that the repair of the defect is not feasible, we reserve the right to instead provide a replacement spa equal in value to the original purchase price of the defective spa. In such an event costs for removal of the defective spa, shipping costs of the replacement spa and delivery will be the responsibility of the spa owner. Bullfrog reserves the right to use either new or reconditioned replacements components. In some situations, the servicing dealer may charge you a reasonable travel mileage fee. Any repair or replacement shall provide no new warranty coverage, but shall retain only the remaining portion of the original product's warranty. Bullfrog's Lifetime warranties provide coverage solely to the original retail purchaser of the spa and extend only for the length of his or her lifetime. If the original retail purchaser is not a natural person (i.e. Corporation, L.L.C., Family Trust, etc.), "life of the purchaser" shall mean ten years. To obtain warranty service, contact your authorized Bullfrog Spa Dealer or Bullfrog and submit proof of purchase. Any defective spa or component sent directly to the factory for warranty repair must be pre-authorized by Bullfrog and must be freight prepaid. Return freight will be paid by Bullfrog on all warranted components and spas, excluding any spa returned that is more than six years after its purchase date. If the entire spa is sent to the factory for repair, all costs of removing and re-installing the spa at spa owner's location will be the responsibility of the spa owner. Repair or replacement, as described above, shall be Bullfrog's sole liability for any breach of this limited warranty.

## Exclusions

With the exception of the BlameFree™ Equipment Warranty, this Bullfrog Spa limited warranty is void if any of the following occur:

- the spa has been subject to alteration, neglect, misuse or abuse.
- any repairs are attempted by anyone other than an authorized agent of Bullfrog.
- the spa has been used in a non-residential application or in an application for which it was not designed.



- damage is caused by an Act of God or any other cause beyond the control of Bullfrog.
- damage is caused by the addition or use of any non-approved mechanical or electrical component, or chemical substance.
- damage is caused by shipping, moving, mishandling, improper installation or electrical hook-up by someone other than Bullfrog.
- damage to the spa shell is caused by excessive heat buildup due to failure to cover spa while empty of water and/or exposed to direct sunlight.
- damage is caused by operating the spa outside the water temperature range of 32°F-120°F (0°C-49°C).

Bullfrog Model #:  Spa Serial #:  Event Code:

First Name: \_\_\_\_\_ Last Name: \_\_\_\_\_

Address: \_\_\_\_\_ City: \_\_\_\_\_

State/Prov: \_\_\_\_\_ Zip/Postal Code: -

Home Phone: -- Work Phone: --

Email Address: \_\_\_\_\_ Date of Purchase: //

Dealer: \_\_\_\_\_ Price: \_\_\_\_\_

**How did you first hear about Bullfrog Spas?**

- Billboard  Dealer  Fair  Homeshow  Magazine Ad  
 Newspaper Ad  Radio Ad  Referred by Bullfrog Owner  Referred by Contractor  Referred by Other  
 Store Location  Television Ad  Website  Yellow Pages  Other \_\_\_\_\_

**What will be the primary usage of your Bullfrog Spa?**

- Arthritis  Enhance Sleep  Entertaining  Family Activity  Health Reasons  Hydrotherapy  Jetted Massage  Recreation  Relaxation

**What other spa brands did you seriously consider purchasing? (Select all that apply)**

- Caldera  Catalina  Artesian  Arctic  Baja  Beachcomber  Cal Spa  
 Marquis  Hot Spring  Coast  Maax Spas  Dimension One  Emerald  Dynasty  
 Sundance  Master  Hydropool  Softub  Jacuzzi  LA  Other \_\_\_\_\_  
 Nordic  PDC  Phoenix  Saratoga  Thermo Spas  Tiger River

**Which features influenced your decision to buy a Bullfrog Spa? (Select all that apply)**

- 56-FramePumps  BlameFree Warranty  Cabinet Materials  Color  Comfort  Style/Appearance  
 Control System  Customization  EnergySave  Filtration System  Friend  Upgradeability  
 FullFoamInsulation  JetPaks  LeakGuard  Lifetime Warranty  Maintenance Free  Store Salesperson  
 Patents  Power of Jetting  PowerPlus  Price/Value  Quality/Durability  
 Reliability  Seating Capacity  Seating Design  Store Reputation

**From the list above, rank in order of importance the three main features that most influenced your decision:**

#1 \_\_\_\_\_ #2 \_\_\_\_\_ #3 \_\_\_\_\_

**Rate your buying experience with your Authorized Bullfrog Spa Dealer in the following categories:**

Category	Excellent	Good	Fair	Poor
Friendliness/Helpfulness of Staff	<input type="checkbox"/>	<input type="checkbox"/>	<input type="checkbox"/>	<input type="checkbox"/>
Knowledge of Bullfrog Product	<input type="checkbox"/>	<input type="checkbox"/>	<input type="checkbox"/>	<input type="checkbox"/>
Knowledge of Other Spa Brands	<input type="checkbox"/>	<input type="checkbox"/>	<input type="checkbox"/>	<input type="checkbox"/>
Knowledge of Chemicals and Accessories	<input type="checkbox"/>	<input type="checkbox"/>	<input type="checkbox"/>	<input type="checkbox"/>
Professionalism	<input type="checkbox"/>	<input type="checkbox"/>	<input type="checkbox"/>	<input type="checkbox"/>
Selection of Bullfrog Models	<input type="checkbox"/>	<input type="checkbox"/>	<input type="checkbox"/>	<input type="checkbox"/>
Selection of other Spa Models	<input type="checkbox"/>	<input type="checkbox"/>	<input type="checkbox"/>	<input type="checkbox"/>
Treated Fairly	<input type="checkbox"/>	<input type="checkbox"/>	<input type="checkbox"/>	<input type="checkbox"/>
Overall Experience	<input type="checkbox"/>	<input type="checkbox"/>	<input type="checkbox"/>	<input type="checkbox"/>

**How often do you plan to use your Bullfrog Spa?**

	Winter	Spring	Summer	Fall
At Least Daily	<input type="checkbox"/>	<input type="checkbox"/>	<input type="checkbox"/>	<input type="checkbox"/>
At Least Weekly	<input type="checkbox"/>	<input type="checkbox"/>	<input type="checkbox"/>	<input type="checkbox"/>
At Least Monthly	<input type="checkbox"/>	<input type="checkbox"/>	<input type="checkbox"/>	<input type="checkbox"/>
At Least Quarterly	<input type="checkbox"/>	<input type="checkbox"/>	<input type="checkbox"/>	<input type="checkbox"/>

**Where will your spa be installed?**

- Indoors  Outdoors

Will you refer a friend to this Dealer?  Yes  No

Did your Dealer use SpaDesign software to help you design your spa?  Yes  No

Do you plan to return to this Dealer to purchase chemicals and/or upgrades for your spa?  Yes  No

Which best describes your age?  Under 25  25-34  35-39  40-44  45-49  50-54  55-65  Over 65

**Which best describes your household income?**

Under \$25,000  \$25,000-\$44,999  \$45,000-\$59,999  \$60,000-\$74,999  \$75,000-\$99,999  \$100,000-\$149,000  \$150,000-\$250,000  Over \$250,000

Thank you for filling out this information. We value your answers and input. We do not sell your information so that other companies may target you for solicitation. Bullfrog will continue to be the industry leader in innovation and technology and would like to keep you informed about exciting new products for your spa.

I do not wish to learn more about Bullfrog Spas or obtain information on new and innovative products.



Bullfrog International, LC  
Product Registration Department  
668 West 14600 South  
Bluffdale, UT 84065



Cut along this line

## Warranty Registration Card

*Mail this card with envelope or register online and receive these important benefits:*

**Warranty Confirmation:** Prompt product registration confirms your right to the protection available under the terms of the Bullfrog Spa Limited Warranty.

**Product Protection:** We will keep the date of purchase and the serial number of your new Bullfrog Spa on record in case you need to refer to this information in the event of an insurance claim such as theft or loss or if we need to contact you for a product recall on any spa component.

**Product Input:** By completing all of the questions on this warranty registration card, you will help us understand more about our customers, their spa usage and the reasons why they choose Bullfrog. This will allow us to continue as the industry leader in innovation and spa technology.

## Obtaining Service

Before requesting service from your dealer, refer to the Troubleshooting section to determine the necessary course of action. If the problem cannot be solved using the Troubleshooting Guide, contact your authorized Bullfrog Spas Dealer.

## Warranty Service

If the spa falls within the warranty period and within the scope of the warranty, contact your authorized Bullfrog Spas Dealer to schedule a service call. You will be required to show proof of purchase.

**NOTE:** Damage caused by repairs made by someone other than an authorized Bullfrog Spas technician will void the spa's warranty.

## Non-Warranty Service

An authorized Bullfrog Spas technician should perform all repairs that fall outside of the warranty coverage or beyond the warranty period. If you are not able to use an authorized technician, you should use genuine Bullfrog Spas replacement parts.



**To register your spa please visit the following web link:  
[www.bullfrogspas.com/register](http://www.bullfrogspas.com/register)**

**Bullfrog**<sup>™</sup>  
INTERNATIONAL, LC

**Bullfrog International, LC**  
668 W. 14600 S.  
Bluffdale, UT 84065  
T: 801.565.8111  
F: 801.565.8333  
E: [info@bullfrogspas.com](mailto:info@bullfrogspas.com)

North America 2009