

# *Coleman Spas 700 Series*



By MAAX

2002

## *Owners Manual*

## Safety Sign

The safety sign enclosed with your Owner's Manual should be permanently installed where visible to the users of the spa.

The sign is adhesive backed and there are also four screws supplied for mounting on rough surfaces.

It is very important that you, as a spa owner, review the important safety instructions before you operate your spa. It is equally important that you instruct all users, even occasional ones, as to the warnings associated with spa use.

You may obtain additional signs or replacement ones by contacting:

MAAX SPAS ARIZONA  
Customer Service  
25605 South Arizona Avenue  
Chandler, Arizona 85248

### **Limited Warranty Summary**

Please see the Warranty Card included with your product for complete warranty information.

Please note that in order to perform prompt warranty service it is extremely important that you return your warranty card complete with model and serial number to MAAX Spas (Arizona), Inc. immediately upon installation.

MAAX Spas (Arizona), Inc. provides a limited warranty to our customers. It applies to the spa structure, surface, most plumbing, the pump, heater, blower, and controls.

The warranty has limitations. These include improper maintenance, improper installation, misuse, abuse, accident, fire, normal wear and tear or improper water maintenance. Unauthorized modifications of the spa may void the warranty. Replacement costs associated with transportation, removal, and reinstallation are the sole responsibility of the spa owner.

This manual refers to only year 2001 model spas. MAAX Spas (Arizona), Inc. reserves the right to make changes in design or material of its products at any time without incurring liability. This limited warranty applies to the first retail purchaser and terminates upon any transfer of ownership.

# IMPORTANT SAFETY INSTRUCTIONS

When installing and using this electrical equipment, basic safety precautions should always be followed, including the following:

(1) **READ AND FOLLOW ALL INSTRUCTIONS.**

- (2) A green colored terminal or a terminal marked G, GR, Ground, Grounding, or the international symbol\*  is located inside the supply terminal box or compartment. To reduce the risk of electric shock, this terminal must be connected to the grounding means provided in the electric supply service panel with a continuous copper wire equivalent in size to the circuit conductors supplying this equipment.

*\*IEC Publication 417, Symbol 5019.*

- (3) At least two lugs marked “BONDING LUGS” are provided on the external surface or on the inside of the supply terminal box or compartment. To reduce the risk of electric shock, connect the local common bonding grid in the area of the hot tub or spa to these terminals with an insulated or bare copper conductor not smaller than No. 6 AWG.
- (4) All field-installed metal components such as rails, ladders, drains or similar hardware within 5 ft of the spa or hot tub shall be bonded to the equipment grounding bus with copper conductors not smaller than No. 6 AWG.

(5) **SAVE THESE INSTRUCTIONS.**

**WARNING:** Children should not use spas or hot tubs without adult supervision

and

**AVERTISSEMENT:** Ne pas laisser les enfants utiliser une cuve de relaxation sans surveillance

and

**WARNING:** Do not use spas or hot tubs unless all suction guards are installed to prevent body and hair entrapment

and

**AVERTISSEMENT:** Pour éviter que les cheveux ou une partie du corps puissent être aspirés, ne pas utiliser une cuve de relaxation si les grilles de prise d'aspiration ne sont pas toutes en place

**WARNING:** People using medications and/or having an adverse medical history should consult a physician before using a spa or hot tub  
and

**AVERTISSEMENT:** Les personnes qui prennent des médicaments ou ont des problèmes de santé devraient consulter un médecin avant d'utiliser une cuve de relaxation

**WARNING:** People with infectious diseases should not use a spa or hot tub  
and

**AVERTISSEMENT:** Les personnes atteintes de maladies infectieuses ne devraient pas utiliser une cuve de relaxation

**WARNING:** To avoid injury exercise care when entering or exiting the spa or hot tub  
and

**AVERTISSEMENT:** Pour éviter des blessures, user de prudence en entrant dans une cuve de relaxation et en sortant

**WARNING:** Do not use drugs or alcohol before or during the use of a spa or hot tub to avoid unconsciousness and possible drowning  
and

**AVERTISSEMENT:** Pour éviter l'évanouissement et la noyade éventuelle, ne prendre ni drogue ni alcool avant d'utiliser une cuve de relaxation ni quand on s'y trouve

**WARNING:** Pregnant or possibly pregnant women should consult a physician before using a spa or hot tub

and

**AVERTISSEMENT:** Les femmes enceintes, que leur grossesse soit confirmée ou non, devraient consulter un médecin avant d'utiliser une cuve de relaxation

## Warnings

**WARNING:** Water temperature in excess of 100°F (38° C) may be injurious to your health and

**AVERTISSEMENT:** Il peut être dangereux pour la santé de se plonger dans de l'eau à plus de 38° C

**WARNING:** Before entering the spa or hot tub measure the water temperature with an accurate thermometer and

**AVERTISSEMENT:** Avant d'utiliser une cuve de relaxation mesurer la température de l'eau à l'aide d'un thermomètre précis

**WARNING:** Do not use a spa or hot tub immediately following strenuous exercise and

**AVERTISSEMENT:** Ne pas utiliser une cuve de relaxation immédiatement après un exercice fatigant

**WARNING:** Prolonged immersion in a spa or hot tub may be injurious to your health and

**AVERTISSEMENT:** L'utilisation prolongée d'une cuve de relaxation peut être dangereuse pour la santé

**WARNING:** Do not permit electric appliances (such as a light, telephone, radio, or television) within 1.5m of the spa or hot tub and

**AVERTISSEMENT:** Ne pas placer d'appareil électrique (luminaire, téléphone, radio, téléviseur, etc) à moins de 1.5, de cette cuve de relaxation

**WARNING:** Maintain water chemistry in accordance with manufacturer's instruction and

**AVERTISSEMENT:** La teneur de l'eau en matières dissoutes doit être conforme aux directives du fabricant.

**WARNING:** The use of alcohol or drugs can greatly increase the risk of fatal hyperthermia in hot tubs and spas and

**AVERTISSEMENT:** La consommation d'alcool ou de drogue augmente considérablement les risques d'hyperthermie mortelle dans une cuve de relaxation.

## HYPERTHERMIA

The causes, symptoms, and effects of hyperthermia may be described as follows. Hyperthermia occurs when the internal temperature of the body reaches a level several degrees above the normal body temperature of 98.6°F (37° C). The symptoms of hyperthermia include drowsiness, lethargy, and an increase in the internal temperature of the body. The effects of hyperthermia include

- (a) unawareness of impending hazard;
- (b) failure to perceive heat;
- (c) failure to recognize the need to exit spas;
- (d) physical inability to exit spa;
- (e) fetal damage in pregnant women; and
- (f) unconsciousness and danger of drowning.

## IMPORTANT SAFETY INSTRUCTIONS

**Caution: Risk of electrical shock.  
Read and follow all instructions.**

When installing and using this electrical equipment, basic safety precautions should always be followed, including the following:

1. **READ AND FOLLOW ALL INSTRUCTIONS.**
2. **Warning:** To reduce the risk of injury, do not permit children to use this product unless they are closely supervised at all times.
3. A wire connector is provided on this unit to connect a minimum No. 6 AWG (5.15 mm<sup>2</sup>) solid copper conductor between this unit and any metal equipment, metal enclosures of electrical equipment, metal water pipe, or conduit within 5 feet (1.5 m) of the unit.
4. **Danger:** Risk of Injury.  
Never connect unit to a power supply with a load controller.

## IMPORTANT SAFETY INSTRUCTIONS

5. **Danger:** Risk of Accidental Drowning. Extreme caution must be exercised to prevent unauthorized access by children. To avoid accidents, ensure that children cannot use this spa unless they are supervised at all times.
6. **Danger:** Risk of Injury. The suction fittings in this spa are sized to match the specific water flow created by the pump. Should the need arise to replace the suction fittings or the pump, be sure that the flow rates are compatible.  
Never operate spa if the suction fittings are broken or missing. Never replace a suction fitting with one rated less than the flow rate marked on the original suction fitting.
7. **Danger:** Risk of Electrical Shock. Install at least 5 ft (1.5 m) from all metal surfaces. As an alternative, a spa may be installed within 5 feet of metal surfaces if each metal surface is permanently connected by a minimum No. 6

AWG (5.15 mm<sup>2</sup>) solid copper conductor attached to the wire connector on the terminal box that is provided for this purpose.

8. **Danger:** Risk of Electric Shock. Do not permit any electric appliance, such as a light, telephone, radio, or television, within 5 ft (1.5 m) of a spa.

**A licensed electrician should make the final electrical connections.**

The electrical supply for this product must include a suitably rated switch or circuit breaker to open all ungrounded supply conductors to comply with section 422-20 of the National Electrical Code ANSI/NFPA 70-1987. This disconnecting means must be readily accessible for operation but installed at least 5 ft. (1.5 m) from the spa as required to comply with local code requirements. All electrical connections should comply with article 680-D of the NEC.

Install to provide drainage of compartment for electrical components.

9. **Warning:** To reduce the risk of injury:
  - a) The water in a spa should never exceed 104°F (40°C) . Water temperatures between 100°F (38°C) and 104°F (40°C) are considered safe for a healthy adult. Lower water temperatures are recommended for young children and when spa use exceeds 10 minutes.
  - b) Since excessive water temperatures have a high potential for causing fetal damage during the early months of pregnancy, pregnant or possibly pregnant women should check with physician before entering spa, and limit spa water temperatures to 100°F (38°C).
  - c) Before entering a spa, the user should measure the water temperature with an accurate thermometer since the tolerance of water temperature-regulating devices varies.
  - d) The use of alcohol, drugs, or medication before or during spa use may lead to unconsciousness with the possibility of drowning.
  - e) Persons suffering from obesity or with a medical history of heart disease, low or high blood pressure, circulatory system problems, or diabetes should consult a physician before using a spa.
  - f) Persons using medication should consult a physician before using a spa since some medication may induce drowsiness while other medication may affect heart rate, blood pressure, and circulation.

# Contents

<b>Important Safety Instructions</b> .....	<b>4</b>	Panel Lock .....	19
Do's and Don'ts .....	5	Temperature Lock .....	20
Hyperthermia .....	5	Auxillary Panel .....	20
<b>Spa System Components</b> .....	<b>6</b>	<b>Safety Features</b> .....	<b>21</b>
<b>Spa Components</b> .....	<b>7</b>	Automatic Time Outs .....	21
<b>Spa Installation</b> .....	<b>8</b>	Error Messages .....	21
Site and Positioning .....	8	<b>Jets, Air Controls and Air Injectors</b> ...	<b>22</b>
Outdoor Installation .....	8	Jets .....	22
Indoor Installation .....	8	Air Controls .....	22
<b>Electrical Information</b> .....	<b>8</b>	<b>Maintenance</b> .....	<b>22</b>
Ground-Fault Circuit-Interrupter ....	8	Water Chemistry .....	22
Important Safety Instructions .....	9	Sanitizing .....	22
Installation Options .....	9	pH Level .....	22
<b>Start Up Procedures</b> .....	<b>10</b>	pH Sensor Operation .....	23
<b>Operating Instructions</b>		Water Maintenance With the	
<b>Models 705TL &amp; 706TL</b> .....	<b>11</b>	Powerworks® Ozonator .....	23
Powerworks 700 Series		Sanitizing With Ozone (CleanZone®) ..	23
Control System .....	11	Specialty Chemicals .....	23
User's Pads .....	11	Hot Water Guide .....	24
Temperature Controls .....	11	Spa Cabinet Care .....	25
Time and Filtration Cycles .....	12	Spa Surface Care and Cleaning .....	25
Preset Filter Cycles .....	13	Filter Maintenance .....	26
Changing Filter Cycles .....	13	Draining Spa .....	26
Ozone Operation (CleanZone®) .....	14	Drain Access .....	26
pH Sensor Operation .....	14	Priming Spa .....	26
Panel Lock .....	14	Winterizing .....	27
Temperature Lock .....	15	Light Bulbs .....	27
Auxillary Panel .....	15	<b>Problem Solving Guide</b> .....	<b>28</b>
<b>Operating Instructions</b>		<b>Spa Soaking Guidelines</b> .....	<b>30</b>
<b>Model 704TL</b> .....	<b>16</b>	<b>Technical Specifications</b> .....	<b>30</b>
Powerworks 700 Series		<b>700 System Wiring Diagram</b> .....	<b>31</b>
Control System .....	16	<b>Safety Sign</b> .....	<b>Back Cover</b>
User's Pads .....	16		
Temperature Controls .....	16		
Time and Filtration Cycles .....	17		
Preset Filter Cycles .....	18		
Changing Filter Cycles .....	18		
Ozone Operation (CleanZone®) .....	19		
pH Sensor Operation .....	19		

## 10. **SAVE THESE INSTRUCTIONS.**

### **Do's and Don'ts**

#### **Do:**

- Replace your cover immediately after use.
- Be aware of the dangers of a wet and slippery surface. Use caution when entering and exiting your spa.
- Have a **licensed electrician** make all final electrical connections.
- Keep your water chemistry correctly balanced. Untreated spa water will cause problems with your spa and equipment as well as being a health risk.
- Clean your filter monthly. (See filter maintenance pg. 21)
- Position your spa in such a way as to leave adequate room to **access all sides** for maintenance purposes.
- Use a bathing cap with long hair.
- Refer to information on hyperthermia on this page.
- Use only authorized spa care products for the best performance and to keep your water properly balanced for years of enjoyment.

#### **Don't:**

- Use the spa at 104°F (40°C) for long periods of time. Do refer to information on hyperthermia on this page.
- Use an extension cord to power your spa.
- Allow anyone to stand on the spa cover. It is not designed to support weight.
- Power the spa unless it is filled with water to the water level mark on the Weir door.
- Operate the pump for extended periods of time with the cover in place. Extended operation can cause heat build-up and interfere with spa operation.

### **Hyperthermia**

The causes, symptoms, and effects of hyperthermia may be described as follows: Hyperthermia occurs when the internal temperature of the body reaches a level several degrees above the normal body temperature of 98.6°F (37°C). The symptoms of hyperthermia include an increase in the internal temperature of the body, dizziness, lethargy, drowsiness, and fainting. The effects of hyperthermia include (1) failure to perceive heat, (2) failure to recognize the need to exit spa or hot tub, (3) unawareness of impending hazard, (4) fetal damage in pregnant women, (5) physical inability to exit the spa or hot tub, and (6) unconsciousness resulting in the danger of drowning.

**Warning:** The use of alcohol, drugs, or medication can greatly increase the risk of fatal hyperthermia.

## 700 Series

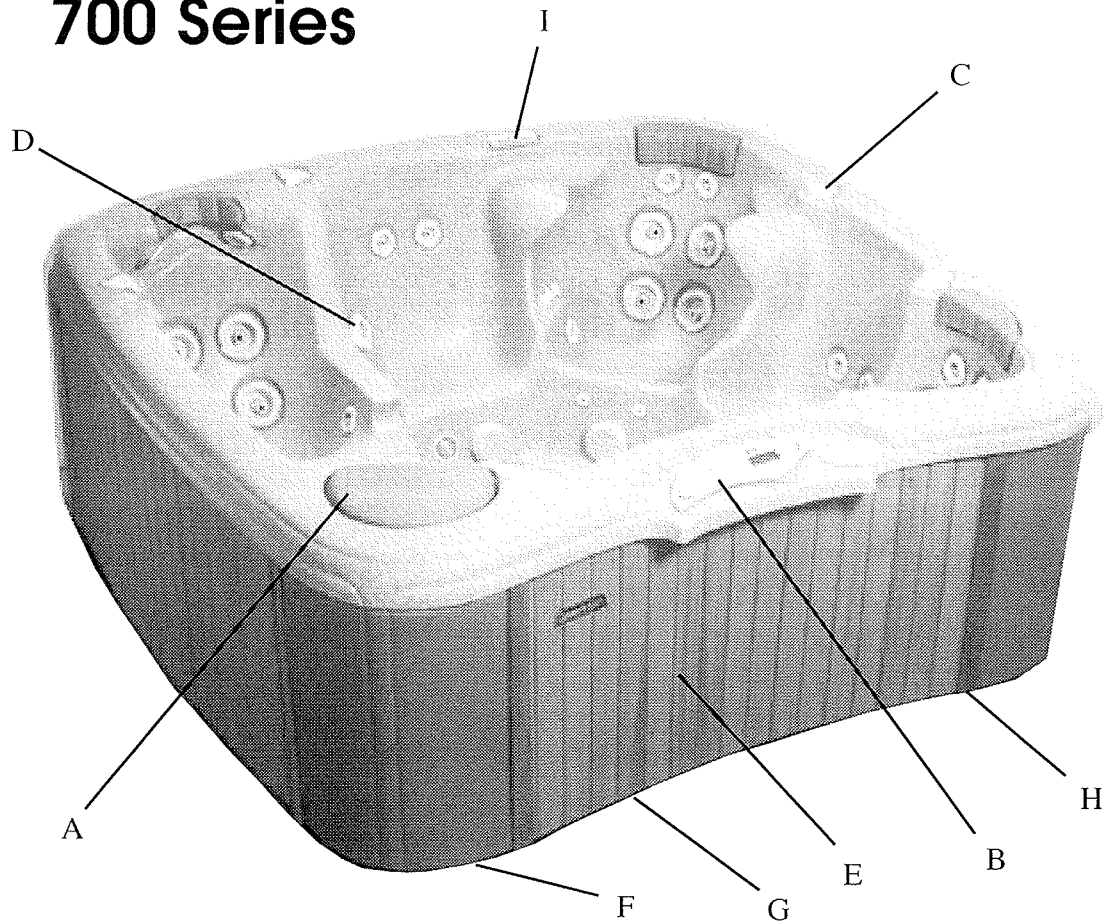

### Spa System Components

- A. Filter Skimmer/Weir Door:** Removes floating debris from the water surface, provides a water return path to equipment, and houses water filter element.
- B. Spa Side Control Panel:** Used to control temperature setting, pump for jets, and light(s).
- C. Air Controls:** Increases or decreases air entering the jets. Close during heating for maximum efficiency.
- D. Diverter/Whirlpool:** Directs the flow from the whirlpool jet to other jets.
- E. Equipment Pack Service Panel (no user serviceable parts):** Spa support system consisting of 2-speed pumps, heater, and associated electrical controls (not shown).
- F. Drain Access (Adjacent to the equipment service panel):** Spa drain faucets.
- G. Fiber Optic Lighting:** Adds beauty and safety to your spa area.
- H. Manufacturer's Identification Label:** Contains identification information for warranty service.
- I. Auxillary Control:** Used to control the pumps from the therapy seat.



## Spa Components

Reference only. Equipment is not always as shown.

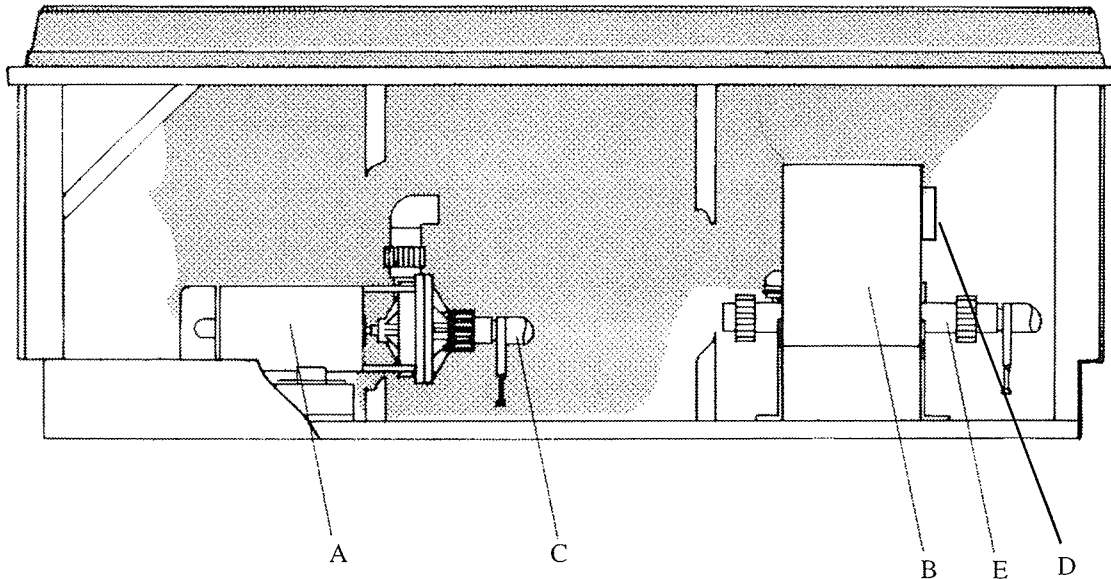

**Note: All sides of spa must be accessible for serviceable parts/components.**

- A. Pumps:** Two or three on 700 Series spas. Low speed for efficient water circulation during filtration and heating; high speed for maximum action of the jets. The pump functions are activated by topside controls.
- B. Warning and Installation Label:** Contains important safety information and installation instructions.
- C. Slice Valves:** Used to shut off water flow from the spa to the equipment while servicing. Quantity will vary from 4 to 9 depending on model. All must be open during normal operations.
- D. Electrical Connections:** The electrical plugs for the unit connect here. All existing connections should be intact.
- E. Heater Assembly:** Thermostatically controlled and equipped with an overheat safety shut-off.

## Spa Installation

**Danger: Risk of electrical shock. Install at least 5 feet from all metal surfaces.**

The electrical supply for this product must include a suitably rated switch or circuit breaker to open all ungrounded supply conductors to comply with Section 422- 20 of the National Electrical Code, ANSI/NFPA70-1987. The disconnecting means must be readily accessible but installed at least 5 feet (1.5 meters) from the spa water. All electrical connections should comply with article 680-D of the NEC.

### Site and Positioning

Locate the spa on solid, level foundation or flooring. Keep in mind the weight of the filled spa (in excess of 4,000 lbs. on some models). If you have any doubts about the load bearing ability of your chosen site, contact an architect, your building department or a building contractor. The entire perimeter of the spa cabinet and the spa bottom must be evenly supported.

If your spa is installed outdoors, we recommend that you provide a concrete pad for the spa to rest on (8ft.x8ft.x4" level pad). Failure to provide a flat, level surface could structurally damage your spa and will void the warranty.

Installation must provide for drainage from the electrical compartment. **The spa must be installed to allow access for service and maintenance on all four sides; therefore, below grade level installation is not recommended.**

### Outdoor Installation

Keep the following additional factors in mind when installing your spa outdoors:

1. Local codes pertaining to fencing.
2. Local electrical and plumbing codes.
3. View from your house.
4. Wind direction.
5. Exposure to sunlight.
6. Location in regard to trees (falling leaves and shade).
7. Dressing and bathroom location.
8. Storage area for maintenance equipment and chemicals.
9. Location to facilitate adult supervision.
10. Landscaping and nighttime lighting.

11. Access to all four cabinet panels.
12. Power supply location and foot traffic.

### Indoor Installation

Keep the following additional factors in mind when installing your spa indoors:

1. Indoor spas promote high humidity, so a means of decreasing humidity must be provided. This can be accomplished by using either ventilation fans or oversized de-humidifiers. Consult your dealer.
2. Floor drains must be provided to drain off water which may cause walking hazards and /or water damage.
3. Floor area should be flat and non-skid. No carpeting, ceramic tile is preferred.
4. Walls, ceilings, woodwork should be of materials capable of withstanding high humidity (redwood, cedar).
5. Be sure floor load bearing capacities are adequate to support the concentrated spa weight.
6. Spas should be double checked for leaks before installing indoors to avoid possible water damage.
7. Indoor sunrooms are capable of maintaining high ambient temperatures which may effect the spa water temperature. It is **NOT** recommended that you operate your filter cycles for longer than 4 hours under these conditions.

## Electrical Information

### Ground-Fault Circuit-Interrupter

A qualified licensed electrician shall connect the spa to a circuit protected by a GFCI. This is a

**Caution: Risk of electrical shock.  
Read and follow all instructions.**

requirement by the National Electric Code, article 680-42, and is also in compliance with Underwriter's Laboratories, Inc.

## Important Safety Instructions

Prior to performing any service to the spa equipment, turn off all primary electrical power at the main circuit breaker or disconnect panel. All field electrical connections can be made by removing the front panel of the electrical control box. To gain access to the control box you must remove the exterior equipment access panel.

All electrical connections to this spa package must be accomplished by a qualified **licensed electrician** in accordance with the National Electrical Code and in accordance with local electrical codes in effect at the time of installation.

All connections should be made in accordance with the wiring diagram in the control box.

This equipment is designed to operate on 60Hz alternating current only, at a voltage of 240 volts as required.

Connections should be made using copper conductors only. The connecting wire and circuit breakers or fuses must all be sized to accommodate the Total Ampere load as specified on the equipment label.

**ALL UNIONS MUST BE HAND-TIGHT AND ALL SLICE VALVES MUST BE LOCKED IN THE "OPEN" POSITION BEFORE FILLING OR REFILLING THE SPA! RUN SPA AND CHECK FOR UNION LEAKS BEFORE RE-INSTALLING FRONT PANEL.**

## Installation Options

### 700 Series

#### 240 Volt / 50 Amp Installation (only)

##### Models:

- 704 Series models.

##### Electrical Requirements:

- 240 Volts, 60Hz, Single Phase, 50 amp. or \*30 amp GFCI, 3 wire service, including ground.

##### \*30 Amp Option (See J9 Diagram)

**The heater can only be activated with the pump on low speed. Only the light can be operating at the same time without disabling the heater. See your authorized Coleman Spas dealer to select this option.**

**Units to be operated at 240 volts must have all electrical connections made by a qualified electrician in accordance with the National Electric Code and in accordance with all local electrical codes in effect at the time of installation.**

A hole can be drilled in the pedestal or base of the unit to bring the conduit to the equipment compartment. Care should be taken to avoid contact

with critical components

Coleman recommends using copper line for all electrical connections.

Coleman spas installed for 240 volt operation require a 3 wire, 50 amp., 240 volt subfeed in non-metallic pipe to the spa equipment compartment (line 1, line 2, and ground). Refer to wiring diagrams on pages 32. A green colored terminal (or wire connector marked "G", "GR", "Grounding") is provided in the control box. To reduce the risk of electrical shock, connect this terminal or connector to the grounding terminal of your electrical service or supply panel with a continuous green insulated copper wire equivalent to the circuit conductor supplying this equipment. In addition, a second pressure wire connector is provided on the surface of the control box for bonding to local ground points. To reduce the risk of electrical shock, this connector should be bonded with a No. 6 AWG copper wire to any metal ladders, water pipes, or any metal within 5 feet of the spa. Coleman recommends using copper wire for all electrical connections.

Jumper J9 Settings			
Input	Jumper Position	Heater & Hi Pump	Heater & Low Pump
240V/30A	20	No	Yes
240V/50A	50	Yes	Yes
240V/40A	20	No	Yes
240V/60A	50	Yes	Yes

#### 240 Volt / 60 Amp Installation

##### Models:

- 705 and 706 Series models.

##### Electrical Requirements:

- 240 Volts, 60Hz, Single Phase, 60 amp. or \*40 amp GFCI, 3 wire service, including ground.

##### \*40 Amp Option (See J9 Diagram)

**The heater can only be activated with the pump on low speed. Only the internal light can be operating at the same time without disabling the heater. See your authorized Coleman Spas dealer to select this option.**

**Units to be operated at 240 volts must have all electrical connections made by a qualified electrician in accordance with the National Electric Code and in accordance with all local electrical codes in effect at the time of installation.**

A hole can be drilled in the pedestal or base of the unit to bring the conduit to the equipment compartment. Care should be taken to avoid contact with critical components.

Coleman recommends using copper line for all electrical connections.

## Start Up Procedures

Coleman spas installed for 240 volt/60 amp operation require a 3 wire, 60 amp., 240 volt sub-feed in nonmetallic pipe to the spa equipment compartment (line 1, line 2, and ground). Refer to wiring diagrams on pages 31 for further details. A green colored terminal (or wire connector marked "G", "GR", or "Grounding") is provided in the control box. To reduce the risk of electrical shock, connect this terminal or connector to the grounding terminal of your electrical service or supply panel with a continuous green insulated copper wire equivalent to the circuit conductor supplying this equipment. In addition, a second pressure wire connector is provided on the surface of the control box for bonding to local ground points. To reduce the risk of electrical shock, this connector should be bonded with a No. 6 AWG copper wire to any metal ladders, water pipes, or any metal within 5 feet of the spa.

The UL and the NEC (National Electric Code) both dictate that the amperage rating and the amperage requirements be listed on all electrical appliances. Coleman Spas supplies both the rating and the requirements printed on our spas and in our manuals. The rating merely designates a class or range of amperages. For example, an appliance rated at 40 amps may actually draw as little as 36 amps or as much as 44 amps. But it is rated at 40 amps regardless. In contrast, the requirement listed on an appliance states the size of load that the wiring, overcurrent protective device, etc. must be capable of supporting in order to supply current to this appliance. This requirement includes a built-in safety factor. Home inspectors, licensed electricians, and UL technicians receive training explaining the difference between these two terms.

The NEC states: "The ampacity of the branch-circuit conductors, and the rating or setting of overcurrent protective devices, shall not be less than 125% of the total load of the nameplate rating" see article 680-41h of the NEC and UL section 63.1.

(UL Device Rating) times 125% = (Device Requirements)

(40 Amperes) times 125% = (50 Amperes)

Therefore a spa with a rating of 40 amperes will need an overcurrent protective device and copper wiring capable of handling 50 Amperes.

## Start Up Procedures

Follow recommendations for site location and electrical connection. The water line on the weir door (see skimmer, page 6) is the level at which the water should be maintained.

**Note: Never operate the spa when the water level is below water level mark on weir door. It can damage the pumps and heater and is potentially dangerous.**

1. Fill the spa through the filter hole to the water line on the weir door with tap water. Never use "softened" water in your spa.
2. Once the water is at the appropriate level, turn power on to unit at circuit breaker or disconnect.
3. Open the air controls and cycle the jets from high to low. Water should come from the therapy jets. If water flow is not established, turn off jets and see Priming Spa (page 26).
4. Add chemicals. See Chemical treatment and Water Maintenance section (pages 22-25).

Follow Operating Instructions for your particular model and set the spa to heat to the desired temperature. Initially you may find that the spa requires 12 to 14 hours to reach temperature. Keep your thermal cover on the unit and close the air controls to help the heating process.

**Important: Do not operate the spa without full water flow.**

# Operating Instructions

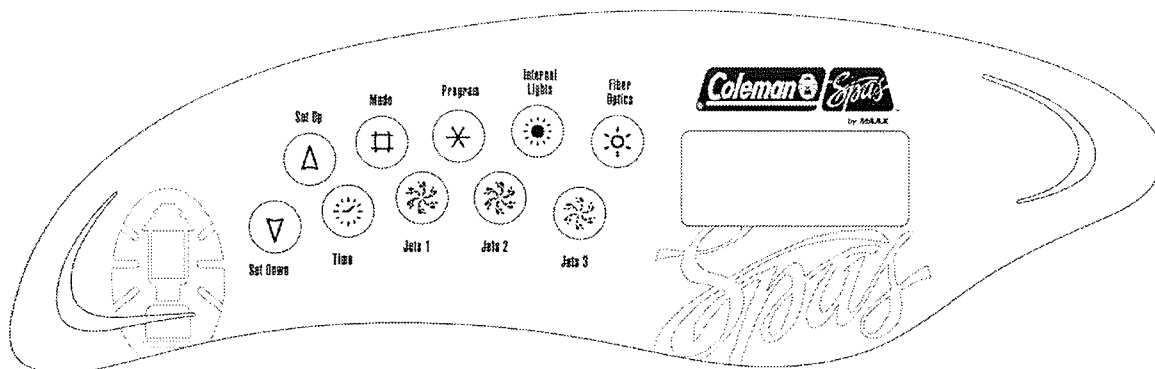

## Powerworks 700 Series Control System

### Models 705TL and 706TL

The 700 series Powerworks Control offers you the ultimate in spa control. The backlit, Liquid Crystal Display (LCD) displays time of day, current water temperature, set point water temperature, operating mode setting, operating status of main equipment, and other special programming features. Each feature of the system is actuated through the control panel pad. Simply touch the appropriate button to activate desired function.

At start up, when power is supplied to the spa, the controls will operate properly and safely under the factory setting. The spa will be in Economy Mode, have a temperature setting of 100°F, and a filtration cycle duration of 3 hours. The time of day setting will vary depending on factory testing. To fully utilize the unique capabilities of the control system, it is important to know how to set the time, set the temperature, operate the pumps, operate the lights, adjust the mode setting, and change the filtration cycles.

### User's Pads

#### Program Pad

**Program** Used in *Time Set Program*, *Filter Set Program*, *Panel Lock Program* and *Temperature Lock Program*.



**Check your water temperature  
before you enter the spa**

#### Mode Standard/Economy Mode



Your spa can be switched from Standard Mode to Economy Mode and vice versa by touching this pad. If your spa is in the Standard Mode, the low speed of Pump 1 and the heater will come on automatically to maintain the set temperature of the water. If your spa is set in the Economy Mode, the heater will operate **ONLY** during the filtration cycles.

The selected mode will be displayed on the right side of the LCD window of the control panel. When in Standard Mode a "Standard" message will be displayed, when in Economy Mode a "Economy" message will be displayed.

**Note:** When in Economy Mode, the heater will not operate during a programmed filtration cycle if the heater is deactivated. Refer to Changing Filter Cycle section on page 13.

**Note:** The Mode pad is used to exit programming for time of day, filtration cycles and panel lock features.

#### Set Up Temperature Controls



Set Down



The set temperature of your spa may easily be increased or decreased at any time using these buttons. The maximum set temperature is 104°F (40°C) and the minimum set temperature is 80°F (27°C). When either pad is touched, the set temperature will be displayed in the LCD window. Each successive touch will change the set temperature 1°F in the chosen direction. After 3 seconds the LCD will automatically display the water temperature.

If the spa is set in Standard mode or in a filtration cycle, adjusting the set temperature may result in activating the heater. When the heater is operating,

## Operating Instructions - Models 705 and 706

the LED light will be activated.

**Note:** 700 Series that are wired 40 Amp option will not heat when Pump #1 is on in high speed, Pump #2 is on in high speed, or Pump #3 is on in high speed.

**Note:** The “Up” and “Down” buttons are used with the inversion feature of the control system. (page 14)

**Note:** The “Up” and “Down” buttons are used while programming the duration of filter cycles. (page 12)

**Note:** The Temperature setting can be locked to prevent unauthorized changes. Refer to Temperature Lock section. (page 15)

Jets 1

### Jets 1



Touch this pad to activate the primary filtration pump. The sequence of jet action is:

- 1-Low whirlpool jets
- 2-High whirlpool jets
- 3-Off

Jets 2

### Jets 2



Touch this pad to activate the second therapy pump. The sequence of the jet action is:

- 1-Low therapy jets
- 2-High therapy jets
- 3-Off

Jets 3

### Jets 3



Touch this pad to activate the third therapy pump. The sequence of the jet action is:

- 1-Low therapy jets
- 2-High therapy jets
- 3-Off

The low speed operations of all pumps are timed to automatically turn off after four hours of operation. The high speed operations of all pumps are timed to automatically turn off after 30 minutes of operation.

**Note:** Pump 1 will automatically operate in low speed whenever the heater is on or a filtration cycle is activated. When a freezing condition is detected, all pumps will come on in low speed. When this automatic activation occurs, the low speed of Pump 1 can not be turned off; however all other control functions can be activated.

### Internal Light **Internal Light**



Touch this pad to turn the internal spa light on and off.

The sequence of operation is:

- 1-High Intensity
- 2-Medium Intensity
- 3-Low Intensity
- 4-Off

The spa light will automatically turn off after 60 minutes of operation.

### Fiber Optic **Fiber Optic Light**



Touch this pad to activate the fiber optic lighting system.

The sequence of operation is:

- 1-Light and Color Wheel on
- 2-Stop Color Wheel, but Light stays on
- 3-Off

The fiber optic system will automatically turn off after 4 hours of operation.

Time

### Time



Touch this pad to view the time of day. Touch a second time to view the temperature setting of the spa. The current spa temperature display will automatically resume after five seconds.

## Time and Filtration Cycles

Your 700 Series control system has been specifically designed so that by simply connecting the spa to its properly grounded source and touching the mode pad, the spa will function properly and safely at 100°F. In this mode, all user pads will be completely functional. To fully utilize the unique capabilities of your control system, it is important to first properly set the time of day.

### Setting The Time

Once your spa has been properly connected, and power is applied, you will notice a “Set Time” Message flashing on the LCD display. To set the time of day:

**Touch**

Time



**Then**

Program



**Then**

Set Up

or

Set Down



After either pad is touched once, the time will increase or decrease in one minute increments. The

“Set Up” pad will move the clock forward, where as the “Set Down” pad will move the clock back.

The setting will advance slowly at first, then speed up after a few moments. Press either the “Set Up” or “Set Down” pad again to stop the time setting cycle.

Once the proper time is set:

**Touch**  **Mode** To exit “Set Time” programming.

**Note:** The clock is on a 24 hour basis. Make sure the time is set to the proper AM /PM setting.

### Preset Filter Cycles

Now that the time has been set correctly, your spa will automatically filter itself for a 3-hour period every 12 hours. Whenever a filter cycle is activated, a message will be displayed on the LCD screen. The following are the preset filter cycles:

#### Filter 1

The first filter cycle is automatically activated at 2:00 AM. The low speed of Pump 1 will be activated. The heater will operate if the water temperature is below the set point. The filter cycle will turn off automatically at 5:00 AM.

#### Filter 2

The second filtration cycle will come on automatically at 2:00 PM. Again, the low speed of Pump 1 will be activated and the heater will operate if the water temperature is below the set point. The second filter cycle will turn off automatically at 5:00 PM. During this cycle, a short purge function occurs on the second and third pumps.

### Changing Filter Cycles

The duration of each filter cycle can be adjusted to any desired duration. The amount of time needed to filter your spa will vary depending on usage and ambient conditions, but Coleman Spas recommends a total of at least 6 hours per day. If the preset times are inconvenient, if a different duration is preferred, or if you wish to leave the heater off during filtering, you will need to reprogram your filter cycles.

**Note: At the start of the second filtration cycle, pumps 2 and 3 are activated. This is to clear the water in the water manifolds and ensure complete filtration**

**Note: To properly clean and maintain your spa, a filter time of at least six hours per day (total of both cycles) is recommended.**

To change the settings of the filter cycles:

**Touch**  **Time** **The LCD window will read:** Actual time of day

**Then**  **Program** “Set Time”

**Then**  **Program** “Set Start Filter 1”

**Touch**  **Set Up** **or**  **Set Down**

to adjust the start time of the first filtration cycle. Once the desired start is set,

**Touch**  **Program**

to set the heater operation. In the “On” position, the heater will be activated during the filter cycle and will heat the water to the set temperature. In the “Off position, the heater will not be activated during the filter cycle.

**Note:** Heater will operate to maintain set temperature in Standard Mode regardless of this setting.

**Touch**  **Set Up** **or**  **Set Down**

to change the heater setting. Once the desired heater position is set,

**Touch**  **Program**

to advance to the next step.

**Touch**  **Set Up** **or**  **Set Down**

to adjust the stop time of the first filtration cycle. Repeat the above steps to set the Start Time, Heater Setting, and Stop Time of the second filtration cycle.

**Touch** Mode



to exit the filter-set procedure. The current water temperature will be displayed in the LCD window.

**Note:** DO NOT override the second filtration cycle under freezing conditions.

If a change is made to the duration while the spa is in a filtration cycle, it will take effect at the start of the next scheduled cycle.

### Clean Up Cycle

After periods of heavy use, you can manually start a clean-up cycle by turning Pump 1 on in low speed. The pump will operate for 4 hours and then automatically turn off. The heater will also operate during this period if the controls are set in Standard Mode.

### Inversion Feature

Your 700 Series Control system is designed to include a display inversion feature. This feature allows you to invert the LCD display for easy viewing while enjoying your spa. To invert the LCD display:

**Touch** Set Up or Set Down



**Then** Jets 1



To cancel the inversion feature, simply repeat the above sequence.

### Ozone Operation (CleanZone®)

All 700 Series spas are equipped with the Coleman Powerworks® Ozonator to assist with your water sanitizing needs. All factory installed ozonators are designed to work in conjunction with an injector system and contact chamber to maximize the sanitizing effects by fully mixing the ozone with the water flow.

The Powerworks Ozonator will produce ozone only when the spa is in a timed filtration cycle. During the filter cycle, activating other functions will suspend ozone production for 30 minutes.

**Note:** Activating the low speed of Pump 1 for a clean up cycle will initiate filtration, but not ozone production, unless the spa enters a timed filter cycle during the 4 hour period.

### pH Sensor Operation

All 700 Series spas are designed to accept an

optional pH sensor to provide accurate pH readings and to assist with water maintenance. To view the pH level, touch the time pad twice. It is recommended that you keep the pH level in the range of 7.2 to 7.6. If the pH of the spa water is outside this range, the display will alternately flash the current temperature and the pH level. If this occurs, add chemicals as necessary to bring pH level into the desired range. See the Winterizing section (page 27) for information on special pH sensor care.

### Locking Features

To help prevent unauthorized use of your spa, the 700 Series control system has been designed with two unique locking features.

#### Panel Lock

To lock the panel and prevent unauthorized use of the controls:

The LCD window will read:

**Touch** Program



**Then** Mode



**Then** Set Up



This sequence must be done within **three seconds** to activate the Panel Lock feature. The LCD window will display the spa temperature along with the lock symbol. All panel pads are deactivated except the Program pad.

When the control panel lock is engaged, all automatic spa functions will operate normally, but none of the settings can be altered.

**To unlock the panel:**

**Touch** Program



**Then** Mode



**Then** Set Down





*Operating Instructions - Model 704TL*

The setting will advance slowly at first, then speed up after a few moments. Press either the “Set Up” or “Set Down” pad again to stop the time setting cycle.

Once the proper time is set:

**Touch** **Mode** To exit “Set Time” programming.



**Note:** The clock is on a 24 hour basis. Make sure the time is set to the proper AM /PM setting.

**Preset Filter Cycles**

Now that the time has been set correctly, your spa will automatically filter itself for a 3-hour period every 12 hours. Whenever a filter cycle is activated, a message will be displayed on the LCD screen. The following are the preset filter cycles:

**Filter 1**

The first filter cycle is automatically activated at 2:00 AM. The low speed of Pump 1 will be activated. The heater will operate if the water temperature is below the set point. The filter cycle will turn off automatically at 5:00 AM.

**Filter 2**

The second filtration cycle will come on automatically at 2:00 PM. Again, the low speed of Pump 1 will be activated and the heater will operate if the water temperature is below the set point. The second filter cycle will turn off automatically at 5:00 PM. During this cycle, a short purge function occurs on the second and third pumps.

**Changing Filter Cycles**

The duration of each filter cycle can be adjusted to any desired duration. The amount of time needed to filter your spa will vary depending on usage and ambient conditions, but Coleman Spas recommends a total of at least 6 hours per day. If the preset times are inconvenient, if a different duration is preferred, or if you wish to leave the heater off during filtering, you will need to reprogram your filter cycles.

To change the settings of the filter cycles:

**The LCD window will read:**

**Touch** **Time** Actual time of day



**Note:** At the start of the second filtration cycle pump 2 is activated. This is to clear the water in the water manifolds and ensure complete filtration.

**Note: To properly clean and maintain your spa, a filter time of at least six hours per day (total of both cycles) is recommended.**

**Then** **Program** “Set Time”



**Then** **Program** “Set Start Filter 1”



**Touch** **Set Up** **or** **Set Down**



to adjust the start time of the first filtration cycle. Once the desired start is set,

**Touch** **Program**



to set the heater operation. In the “On” position, the heater will be activated during the filter cycle and will heat the water to the set temperature. In the “Off” position, the heater will not be activated during the filter cycle. Note that the heater will operate to maintain set temperature in standard mode regardless of this setting.

**Touch** **Set Up** **or** **Set Down**



to change the heater setting. Once the desired heater position is set,

**Touch** **Program**



to advance to the next step.

**Touch** **Set Up** **or** **Set Down**











to adjust the stop time of the first filtration cycle. Repeat the above steps to set the Start Time, Heater Setting, and Stop Time of the second filtration cycle.

Again, this sequence must be done within three seconds to deactivate the Panel Lock feature. When the last pad is pressed, the lock symbol will disappear and all pads will become active.



### Temperature Lock

To lock the temperature setting and prevent any unauthorized temperature adjustment of your spa water:

<b>Touch</b>	Set Up	or	Set Down	
				
<b>Then</b>	Program			<b>The LCD window will read:</b>
				
<b>Then</b>	Mode			
				
<b>Then</b>	Set Up			
				

To activate the Temperature Lock feature, this sequence must be done within three seconds. The LCD window will display the water temperature along with the lock symbol. Both temperature pads will be deactivated and when pushed, the set temperature will appear in the LCD window next to a double arrow.

#### To unlock the panel:

<b>Touch</b>	Program
	
<b>Then</b>	Mode
	
<b>Then</b>	Set Down
	

Again, this sequence must be done within three seconds to deactivate the Temperature Lock feature. When the last pad is pressed, the lock symbol will disappear and the temperature pads will become active.

### Auxiliary Panel

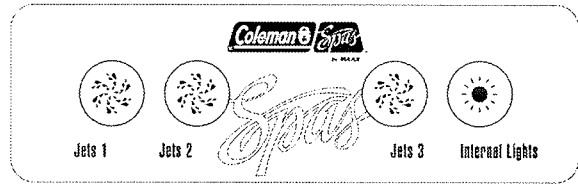

The auxiliary control panel allows you to operate all three pumps and the internal light without leaving the comfort of the feature seat.

**Jets 1**  
 **Jets 1**  
 Touch this pad to activate the primary filtration pump. The sequence of the jet action is:

- 1–Low whirlpool jets
- 2–High whirlpool jets
- 3–Off

**Jets 2**  
 **Jets 2**  
 Touch this pad to activate the second therapy pump. The sequence of the jet action is:

- 1–Low therapy jets
- 2–High therapy jets
- 3–Off

**Jets 3**  
 **Jets 3**  
 Touch this pad to activate the third therapy pump. The sequence of the jet action is:

- 1–Low therapy jets
- 2–High therapy jets
- 3–Off

**Internal Light**  
 **Internal Light**  
 Touch this pad to turn the internal spa light on and off. The sequence of the jet action is:

- 1–High Intensity
- 2–Medium Intensity
- 3–Low Intensity
- 4–Off

# Operating Instructions

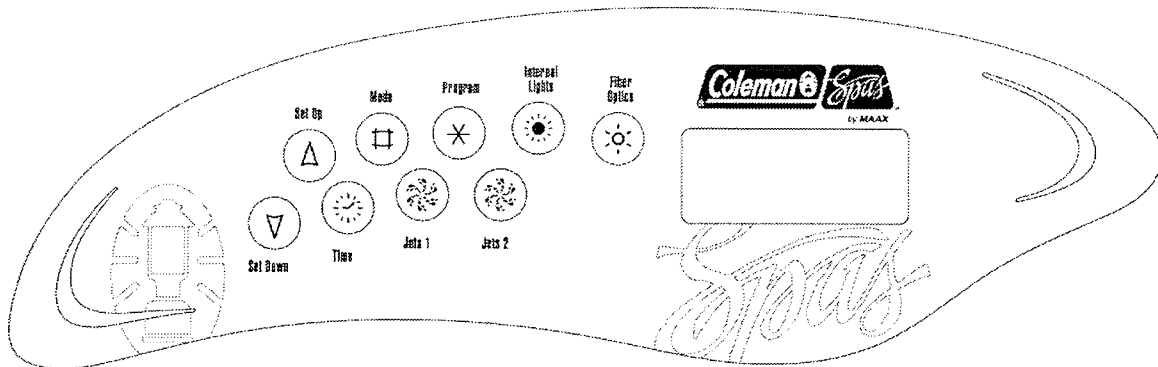

## Powerworks 700 Series Control System Model 704TL

The 700 series Powerworks Control offers you the ultimate in spa control. The backlit, Liquid Crystal Display (LCD) displays time of day, current water temperature, set point water temperature, operating mode setting, operating status of main equipment, and other special programming features. Each feature of the system is actuated through the control panel pad. Simply touch the appropriate button to activate desired function.

At start up, when power is supplied to the spa, the controls will operate properly and safely under the factory setting. The spa will be in Economy Mode, have a temperature setting of 100°F, and a filtration cycle duration of 3 hours. The time of day setting will vary depending on factory testing. To fully utilize the unique capabilities of the control system, it is important to know how to set the time, set the temperature, operate the pumps, operate the lights, adjust the mode setting, and change the filtration cycles.

### User's Pads

#### Program **Program Pad**



Used for initiating *Time Set Program*, *Filter Set Program*, *Panel Lock Program* and *Temperature Lock Program*.

**Check your water temperature  
before you enter the spa**

#### Mode **Standard/Economy Mode**



Your spa can be switched from Standard Mode to Economy Mode and vice versa by touching this pad. If your spa is in the Standard Mode, the low speed of Pump 1 and the heater will come on automatically to maintain the set temperature of the water. If your spa is set in the Economy Mode, the heater will operate **ONLY** during the filtration cycles.

The selected mode will be displayed on the right side of the LCD window of the control panel. When in Standard Mode a "Standard" message will be displayed, when in Economy Mode a "Economy" message will be displayed.

**Note:** When in Economy Mode, the heater will not operate during a programmed filtration cycle if the heater is deactivated. Refer to Changing Filter Cycle section on page 18.

**Note:** The Mode pad is used to exit programming for time of day, filtration cycle and panel lock features.

### Temperature Controls

**Set Up** The set temperature of your spa may easily be increased or decreased at any time using these buttons. The maximum set temperature is 104°F (40°C) and the minimum set temperature is 80°F (27°C).

**Set Down** When either pad is touched, the set temperature will be displayed in the LCD window. Each successive touch will change the set temperature 1°F in the chosen direction. After 3 seconds the LCD will automatically display the water temperature.

If the spa is set in Standard mode or in a filtration cycle, adjusting the set temperature may result in activating the heater. When the heater is operating, the LED light will be activated.

**Note:** 704 Series that are wired 30 Amp option will not heat when Pump #1 is on in high speed or Pump #2 is on in high speed.

**Note:** The “Up” and “Down” buttons are used with the inversion feature of the control system. (page 19)

**Note:** The “Up” and “Down” buttons are used while programming the duration of filter cycles. (page 18)

**Note:** The Temperature setting can be locked to prevent unauthorized changes. Refer to Temperature Lock section. (page 19)

**Jets 1    Jets 1**



Touch this pad to activate the primary filtration pump. The sequence of jet action is:

- 1-Low whirlpool jets
- 2-High whirlpool jets
- 3-Off

**Jets 2    Jets 2**



Touch this pad to activate the second therapy pump. The sequence of the jet action is:

- 1-Low therapy jets
- 2-High therapy jets
- 3-Off

The low speed operations of all pumps are timed to automatically turn off after four hours of operation. The high speed operations of all pumps are timed to automatically turn off after 30 minutes of operation.

**Note:** Pump 1 will automatically operate in low speed whenever the heater is on, a filtration cycle is activated, or when a freezing condition is detected. When this automatic activation occurs, the low speed of Pump 1 can not be turned off; however all other control functions can be activated.

**Internal Light    Internal Light**



Touch this pad to turn the internal spa light on and off.

The sequence of operation is:

- 1-High Intensity
- 2-Medium Intensity
- 3-Low Intensity
- 4-Off

The spa light will automatically turn off after 60 minutes of operation.

**Fiber Optic    Fiber Optic Light**



Touch this pad to activate the fiber optic lighting system.

The sequence of operation is:

- 1-Light and Color Wheel on
- 2-Stop Color Wheel, but Light stays on
- 3-Off

The fiber optic system will automatically turn off after 4 hours of operation.

**Time    Time**



Touch this pad to view the time of day. Touch a second time to view the temperature setting of the spa. The current spa temperature display will automatically resume after five seconds.

**Time and Filtration Cycles**

Your 700 Series control system has been specifically designed so that by simply connecting the spa to its properly grounded source and touching the mode pad, the spa will function properly and safely at 100°F. In this mode, all user pads will be completely functional. To fully utilize the unique capabilities of your control system, it is important to first properly set the time of day.

**Setting The Time**

Once your spa has been properly connected, and power is applied, you will notice a “Set Time” Message flashing on the LCD display. To set the time of day:

**Touch    Time**



**Then    Program**



**Then    Set Up    or    Set Down**



After either pad is touched once, the time will increase or decrease in one minute increments. The “Set Up” pad will move the clock forward, where as the “Set Down” pad will move the clock back.

**Touch** Mode



to exit the filter-set procedure. The current water temperature will be displayed in the LCD window.

**Note:** DO NOT override the second filtration cycle under freezing conditions.

If a change is made to the duration while the spa is in a filtration cycle, it will take effect immediately. If the change is made outside a filtration cycle, it will take effect at the start of the next scheduled cycle.

### Clean Up Cycle

After periods of heavy use, you can manually start a clean-up cycle by turning Pump 1 on in low speed. The pump will operate for 4 hours and then automatically turn off. The heater will also operate during this period if the controls are set in Standard Mode.

### Inversion Feature

Your 700 Series Control system is designed to include a display inversion feature. This feature allows you to invert the LCD display for easy viewing while enjoying your spa. To invert the LCD display:

**Touch** Set Up or Set Down



**Then** Jets 1



To cancel the inversion feature, simply repeat the above sequence.

### Ozone Operation (CleanZone®)

All 700 Series spas are equipped with the Coleman Powerworks® Ozonator to assist with your water sanitizing needs. All factory installed ozonators are designed to work in conjunction with an injector system and contact chamber to maximize the sanitizing effects by fully mixing the ozone with the water flow.

The Powerworks® Ozonator will produce ozone only when the spa is in a timed filtration cycle. During the filter cycle, activating other functions will suspend ozone production for 30 minutes.

**Note:** Activating the low speed of Pump 1 for a clean up cycle will initiate filtration, but not ozone production, unless the spa enters a timed filter cycle during the 4 hour period.

### pH Sensor Operation

All 700 Series spas are designed to accept an

optional pH sensor to provide accurate pH readings and to assist with water maintenance. To view the pH level, touch the time pad twice. It is recommended that you keep the pH level in the range of 7.2 to 7.6. If the pH of the spa water is outside this range, the display will alternately flash the current temperature and the pH level. If this occurs, add chemicals as necessary to bring pH level into the desired range. See the Winterizing section (page 27) for information on special pH sensor care.

### Locking Features

To help prevent unauthorized use of your spa, the 700 Series control system has been designed with two unique locking features.

#### Panel Lock

To lock the panel and prevent unauthorized use of the controls:

The LCD window will read:

**Touch** Program



**Then** Mode



**Then** Set Up



This sequence must be done within **three seconds** to activate the Panel Lock feature. The LCD window will display the spa temperature along with the lock symbol. All panel pads are deactivated except the Program pad.

When the control panel lock is engaged, all automatic spa functions will operate normally, but none of the settings can be altered.

#### To unlock the panel:

**Touch** Program



**Then** Mode



**Then** Set Down











*Operating Instructions - Model 704TL*

Again, this sequence must be done within three seconds to deactivate the Panel Lock feature. When the last pad is pressed, the lock symbol will disappear and all pads will become active.



**Temperature Lock**

To lock the temperature setting and prevent any unauthorized temperature adjustment of your spa water:

<b>Touch</b>	Set Up	or	Set Down	
				
	The LCD window will read:			
<b>Then</b>	Program			
				
<b>Then</b>	Mode			
				
<b>Then</b>	Set Up			
				

To activate the Temperature Lock feature, this sequence must be done within three seconds. The LCD window will display the water temperature along with the lock symbol. Both temperature pads will be deactivated and when pushed, the set temperature will appear in the LCD window next to a double arrow.

**To unlock the panel:**



<b>Touch</b>	Program
	
<b>Then</b>	Mode
	
<b>Then</b>	Set Down
	

Again, this sequence must be done within three seconds to deactivate the Temperature Lock feature. When the last pad is pressed, the lock symbol will disappear and the temperature pads will become active.

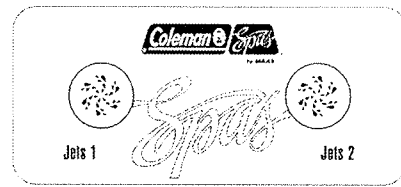
**Auxiliary Panel**



The auxiliary control panel allows you to operate both pumps without leaving the comfort of the feature seat.

- |   |  |
|---|--|
|  | <b>Jets 1</b>  |
|   | Touch this pad to activate the primary filtration pump. The sequence of the jet action is: |
|   | 1–Low whirlpool jets   |
|   | 2–High whirlpool jets  |
|   | 3–Off  |
|  | <b>Jets 2</b>  |
|   | Touch this pad to activate the second therapy pump. The sequence of the jet action is:     |
|   | 1–Low therapy jets   |
|   | 2–High therapy jets  |
|   | 3–Off  |

## Safety Features

Your Coleman spa is equipped with several safety features which are designed to protect the user and the equipment.

### Automatic Time Outs

#### 700 Series

The 700 Series control system is designed with automatic time outs on all equipment. The low speed operations of all pumps and fiber optic systems are designed to turn off after four hours of operation. The high speed operations of all pumps are designed to turn off after 30 minutes. The internal spa light will turn off automatically after 1 hour.

### Error Messages

The 700 Series control system is designed with several error messages that will automatically be displayed on the LCD screen. These messages help describe the operating status of your spa.

**OH1**

#### Water Overheat Protection

Each 700 Series control is equipped with a temperature sensor. If a problem is detected with the temperature sensor, an “OH1” symbol will be displayed in the LCD window.

The water temperature sensor constantly monitors the temperature of the spa water. If at any time the spa water reaches a temperature of 112°F, the spa will be disabled. Once the water temperature cools down to a temperature below 110°F the spa will automatically be reset.

**OH2**

#### Hi-Limit Overheat Protection

Each 700 Series control is also equipped with a hi-limit sensor. If a problem is detected with the hi-limit sensor, an “OH2” symbol will be displayed in the LCD window.

The hi-limit sensor constantly monitors the temperature of the heater housing. If at any time the heater housing reaches a temperature of 118°F the spa will be disabled. When the heater temperature cools down to 116°F, the spa can be reset by touching the “Mode” pad on the control panel. An overheat condition caused by the hi-limit sensor is often caused by a faulty flow switch or restricted water flow and should be investigated thoroughly prior to resetting the controls.

**Note:** After a “OH” message, it is important that you check the water temperature before entering the spa.

**Note:** If the “OH” message remains, the spa water temperature does not go down, or the spa will not accept a reset, contact your dealer immediately and DO NOT use the spa.

**FL1**

#### Open Flow Switch

Each 700 Series spa is equipped with a pressure switch located on the tailpiece of the heater that allows the control system to detect problems with water flow conditions. If a *Low Flow* condition is detected, the “FL1” symbol will be displayed in the LCD window.

A low flow condition will occur when the pressure switch fails to close while the pump is operating on low speed. Check to make sure all slice valves are open, that there are no obstructions in the pump or water line, and that the filter is clean of any debris. If the problem persists, contact your dealer for assistance.

**FL2**

#### Closed Flow Switch

If a “FL2” message is displayed in the LCD window, a *No Flow* situation has occurred and the spa will be deactivated. A *No Flow* condition will occur when the pressure switch is in a closed position without the pump running. Contact your dealer immediately for assistance and DO NOT use the spa.

**SN1**

#### Open Sensor Detection - Hi-Limit

If a “SN1” message is displayed in the LCD window, a problem with the Hi-Limit sensor has been detected. The sensor is non-functional and the spa will be deactivated. Contact your local dealer for assistance.

**SN2**

#### Open Sensor Detection - Temperature

If a “SN2” message is displayed in the LCD window, a problem with the Temperature sensor has been detected. The sensor is non-functional and the spa will be deactivated. Contact your local dealer for assistance.

**COOL**

#### Temperature Set Back

If the control system detects that the spa water is 20°F (6.7°C) cooler than the temperature set point, a “COOL” message will be displayed in the LCD window. The heater will automatically activate to provide heat and freeze protection. No corrective action is necessary.

**ICE**

#### Freeze Protection

Your 700 Series control system is also equipped with a freeze protection program. When a freeze condition is detected (temperature of the heater tube is below 40°F) the system software will automatically activate the pumps to circulate the water. The operation of the pumps is a normal spa function and no corrective action is necessary.

## Jets, Air Controls and Air Injectors

### Jets

Coleman's 700 Series jets are individually engineered to provide a unique hydro-massage. The jet system is designed so that all like sized jet nozzles are interchangeable and can be added in any quantity. All full sized jets are adjustable from a fully open to a closed position. It is very important that you NEVER SHUT ALL FULL SIZED JETS OFF AT ONE TIME! Depending on the model, your spa will have a combination of the following jets.

**Cyclone Therapeutic (XL Cyclone, Cyclone, & LS Luxury):** Positioned to focus on large muscle groups, these jets deliver a concentrated, high volume stream of water for a deep massage. Each jet is fully adjustable, allowing users to set the water flow to the most comfortable setting. The nozzle can be rotated to target sore muscle areas.

**Cyclone Turbo Swirl Jets (XL Cyclone, Cyclone, & LS Luxury):** Positioned to focus on muscle tension zones, these jets deliver a spinning V-shaped water stream for a gentle, pulsating massage. Each jet is fully adjustable, allowing users to set the water flow to the most comfortable setting.

**Diverter/Whirlpool:** Positioned to create overall water circulation, this multi-purpose, high volume jet provides whirlpool action throughout the entire spa. In the "on" position the high volume water stream provides either a deep massage for the lower back area or a soothing all-over body massage. In the "off" position, water flow is diverted to 3 or 4 other spa jets.

**Euro Jets:** Positioned in the footwell and forearm areas of the spa, these jets deliver a penetrating massage to dissolve tension in the lower legs and wrists. The two Euro jets in the footwell are the entry point for ozone produced during the automatic filtration cycles. Euro jets are not adjustable.

**Note:** Ozone production is suspended when other functions are activated on the control panel.

### Air Controls

The intensity of the jet action can be controlled by altering the amount of air injected with water through the jets. Your 700 Series spa will have either 4 or 5 air controls located on the lip of the spa. Each control activates air to specific jets in the spa, allowing you to create various combinations and levels of jet action to suit individual taste.

**Note: Air controls should be closed during heating cycles for maximum energy efficiency.**

## Maintenance

### Water Chemistry

Water chemistry is critical in a spa system. The combination of high temperature and small volume means that the chemical balance must be watched carefully. Use only authorized spa care products for the best performance and to keep your water properly balanced for years of enjoyment. For water usage information, please see the table on page 24.

### Sanitizing

Sanitizing your water destroys harmful organisms and keeps your spa healthy and safe. Two commonly used spa sanitizers are bromine and chlorine, with ozone being used as an oxidizer. Chlorine and bromine are chemicals that you will add to the water. Ozone is a gas that is produced by an ozonator and injected into the water. It is important that a residual of sanitizer remain in your water. High water temperature, aeration and use will increase the need for sanitizer. In addition to maintaining a residual, it is important to "shock" your spa water periodically and after heavy use. The addition of substantial amounts of sanitizer super-chlorinates the water and oxidizes non-filterable organic residue. Allow the sanitizer level to drop back to the residual amount before using. Also use your Clean Up Cycle (page 14), after heavy use for additional filtration. **Note:** Coleman Spas does not recommend the use of trichlor (swimming pool chlorine) in its spas.

### pH Level

pH is a balance of acidity and alkalinity in the water. Maintaining proper pH is important for the effectiveness of your sanitizer, for user comfort and to prevent corrosion of the spa equipment.

**Note:** Keep a chlorine or bromine residual of 3.0 to 5.0 ppm. Tests should be done daily with your test kit.

**Note:** Never mix two chemicals together. Never store any chemicals in the equipment compartment.

**Note:** Do not use muriatic acid to balance pH as it will damage your spa surface and equipment.



### **Recommended Levels**

**pH:** 7.2–7.6 (Ideal 7.4–7.6)

**Sanitizer Residual:** 3.0–5.0 ppm

**Total Dissolved Solids:** 100–200 ppm

**Free Available Sanitizer:** 3.0–5.0 ppm

**Total Alkalinity:** 80–100 ppm ideal for dichlor, and bromine.

**Note:** Make sure you use fresh test kit reagents. They lose their accuracy with age. (Date the bottle upon purchase). The use of a tri-color test kit is recommended.

### **pH Sensor Operation**

700 series spas equipped with the pH sensor option will provide a pH reading to assist water maintenance. To view pH, touch the time pad twice. Recommended range is 7.2 to 7.6. If the pH of the spa water is outside of this range, the display will alternately flash the current temperature and pH reading. If this occurs, add chemicals as necessary to bring the pH into range.

## **Water Maintenance With the Powerworks® Ozonator**

Your 700 Series spa is equipped with a Powerworks® Ozonator. The use of ozone in conjunction with the normal spa sanitizing and water balancing chemicals will give you a cleaner, healthier spa environment. Maintenance and chemical usage may be reduced, and you will enjoy cleaner water.

### **Sanitizing With Ozone/CleanZone®**

Spas vary in size and the amount that they are used will vary considerably from family to family. For this reason you will need to establish your sanitizing program based upon your own personal use. When using ozone you should start by balancing your water chemistry as you normally would. A spa should run and be ozonated no less than four hours per day. This starting point should **NOT** be considered final. If your spa is heavily used, this run time should be increased. Your spa produces ozone during filtration cycles. (See page 14).

The amount of a residual sanitizer (chlorine or bromine) that you maintain in the water will also vary depending on use. It is recommended that you maintain a residual of 3.0–5.0 ppm. Periodically, and after periods of heavy use, it is necessary to “shock” your spa with additional amounts of sanitizer. Refer to your spa care products for further information.

## **Specialty Chemicals**

Although ozone will reduce the need for specialty chemicals, it is recommended to always have some on hand. There may come a time when you will be required to add some of these due to heavy usage of the spa or when changing the water.

If you are in an area which has metals in the source water, a specialty chemical program should be followed to avoid staining. Use only authorized spa care products for the best performance and to keep your water properly balanced for years of enjoyment.

The following guidelines cover the most common procedures when operating a spa. Should you encounter a situation which you don't completely understand, contact your dealer for assistance.

## Hot Water Guide

Problem	Cause	Solution
Cloudy Water	<ul style="list-style-type: none"> <li>• Inadequate filtration/dirty filter</li> <li>• Excessive oils/organic matter</li> <li>• Improper sanitation/bacteria</li> <li>• High pH and/or high alkalinity</li> <li>• High total dissolved solids (TDS)</li> </ul>	<ul style="list-style-type: none"> <li>• Check to make sure the filter is running properly/Clean filter with a filter cleaner or degreaser.</li> <li>• Shock the spa with a chlorine or bromine sanitizer/shock or other shock treatment product.</li> <li>• Increase sanitizer level to balance water and shock if needed.</li> <li>• Adjust pH; add appropriate sodium bisulfate product.</li> <li>• Depending on the severity-drain the spa to half and refill; or drain the spa completely, clean and refill.</li> </ul>
Water Odor	<ul style="list-style-type: none"> <li>• Excessive organics/too many chloramines insufficient free chlorine available</li> <li>• Improper sanitation</li> <li>• Inadequate filtration</li> <li>• Low pH</li> </ul>	<ul style="list-style-type: none"> <li>• Shock the spa with a chlorine or bromine sanitizer/shock or other shock treatment product.</li> <li>• Increase sanitizer level to balance water; shock if needed.</li> <li>• Check to make sure the filter is running properly/Clean filter with a filter cleaner or degreaser.</li> <li>• Raise pH with sodium bicarbonate product. If metals are present, add chelating agent.</li> </ul>
Chlorine Odor	<ul style="list-style-type: none"> <li>• Too many chloramines-insufficient free chlorine available</li> <li>• Low pH</li> </ul>	<ul style="list-style-type: none"> <li>• Shock the spa with a chlorine sanitizer/shock or non-chlorine shock treatment.</li> <li>• Adjust pH; raise pH with sodium bicarbonate product.</li> </ul>
Bromine Odor/ Yellow Water	<ul style="list-style-type: none"> <li>• Low pH</li> </ul>	<ul style="list-style-type: none"> <li>• Adjust pH; raise pH with sodium bicarbonate product.</li> </ul>
Musty Odor	<ul style="list-style-type: none"> <li>• Bacterial or algae growth</li> </ul>	<ul style="list-style-type: none"> <li>• Shock the spa with a chlorine or bromine sanitizer/shock or equivalent shock treatment product. If problem is visible drain, clean, refill and balance spa.</li> </ul>
Foaming/Scum Ring Around the Tub	<ul style="list-style-type: none"> <li>• Build up of body oils, lotion and chemicals resulting from soap or detergent</li> </ul>	<ul style="list-style-type: none"> <li>• Add defoamer; or drain and refill.</li> </ul>
Algae	<ul style="list-style-type: none"> <li>• pH Imbalance</li> <li>• Low free chlorine or bromine concentration</li> </ul>	<ul style="list-style-type: none"> <li>• Adjust pH</li> <li>• Shock with a chlorine or bromine sanitizer/shock or other shock treatment product.</li> </ul>
Eye Irritation	<ul style="list-style-type: none"> <li>• Low pH</li> <li>• Insufficient free available chlorine</li> </ul>	<ul style="list-style-type: none"> <li>• Raise pH with sodium bicarbonate product.</li> <li>• Shock with a chlorine sanitizer/shock or other shock treatment product.</li> </ul>

Skin Irritation/ Rash	<ul style="list-style-type: none"> <li>• Unsanitary/polluted water</li> <li>• Soaking too long</li> <li>• Water temperature too high</li> </ul>	<ul style="list-style-type: none"> <li>• Keep recommended sanitizer residual at all times; superchlorinate or use a non-chlorine shock treatment.</li> <li>• Soak for smaller intervals, such as 15 minutes.</li> <li>• Reduce water temperature.</li> </ul>
Scale	<ul style="list-style-type: none"> <li>• Too much calcium dissolved in water</li> <li>• pH and total alkalinity too high</li> </ul>	<ul style="list-style-type: none"> <li>• Add a scale control product. Adjust total alkalinity and pH levels by adding the appropriate sodium bisulfate product; with concentrated scale deposits-drain the spa, scrub the scale off, refill the spa and balance the water.</li> </ul>
Erratic pH Test Results/Unusual pH Test Color	<ul style="list-style-type: none"> <li>• Sanitizer level too high</li> <li>• Old pH indicator dye</li> </ul>	<ul style="list-style-type: none"> <li>• Test the pH, when the sanitizer level is below 5 ppm</li> <li>• Replace the pH indicator dye.</li> </ul>
Sanitizer Dissipating Too Rapidly	<ul style="list-style-type: none"> <li>• Excessive organics in water</li> <li>• Temperature too high</li> <li>• Low pH</li> <li>• Low pH Corrosion of Metal Fixtures</li> <li>• Low calcium hardness</li> <li>• Low total alkalinity</li> </ul>	<ul style="list-style-type: none"> <li>• Increase shock dosage; add sanitizer; have bathers shower before entering spa.</li> <li>• Reduce temperature.</li> <li>• Raise pH with sodium bicarbonate product.</li> <li>• Use a chelating agent if metals are present. Keep proper pH level (7.2 to 7.6).</li> <li>• Use a chelating agent if metals are present. Maintain minimum 150-200 ppm calcium hardness.</li> <li>• Use a chelating agent if metals are present. Maintain proper alkalinity for type of sanitizer used.</li> </ul>

## Spa Cabinet Care

Your custom spa cabinet is made from quality handcrafted cedar and high impact Luran®. The wood has been treated with a sealer and stain prior to spa assembly to preserve its appearance and help prevent weathering. Further wood protection requirements depend on spa location (indoors or outdoors, sun, shade, etc.), and local climate conditions. **Re-treat 3 to 4 times per year, with an appropriate product recommended by your authorized dealer.**

**Cleaning the spa cabinet:** Rinse dirt and dust regularly with clean water. To remove stubborn dirt, grime, and mild discoloration, wash with a mild detergent and warm water.

## Spa Surface Care and Cleaning

Your spa shell is made of a reinforced acrylic material. A minimum amount of care and cleaning will keep your spa looking new for years.

**To protect your spa finish, always keep your cover on the spa when not in use.**

Use a spa cleaner for residue and lime buildup at the water level of the spa surface. This can be applied to the acrylic surface with a soft cloth and wiped clean. Use small amounts to avoid polluting spa water. It may be necessary to lower the water level 2 to 3 inches before cleaning if heavily soiled at the waterline.

Use common household, non-abrasive cleaners to clean your spa shell. (For example: Lysol Basin, Tub & Tile Cleaner®; Glass Plus®; Mr. Clean®; and Top Job®, or a mild dishwashing detergent such as Ivory® Liquid.) Rinse well and dry with a clean cloth.

Do not allow your spa's acrylic surface to come

**Never use abrasive cleaners.**

into contact with products such as acetone (nail polish remover), nail polish, dry cleaning solution, lacquer thinners, gasoline, pine oil, etc.

Remove dust and dry dirt with a soft, damp cloth.

Clean grease, oil, paint and ink stains with isopropyl (rubbing) alcohol.

Avoid using razor blades or other sharp instruments that might scratch the surface.

## Filter Maintenance

The removable filter cartridge is located in the filter canister beneath the strainer basket. The filter should be inspected at least **monthly during normal use**, and more often during heavy use.

**Keep the filter clean! A clogged filter decreases both performance and water quality.**

**To clean the filter, simply follow these steps:**  
(Note: It is not necessary to drain the spa.)

1. Turn the pump off.
2. Remove skimmer lid.
3. Remove strainer basket.
4. Remove filter cartridge from the filter canister by grasping the top and lifting upwards.
5. Soak filter in filter cleaner/degreaser and hose out filter cartridge, unless replacing with new cartridge.
6. Place filter cartridge back into filter canister. When the spa is empty the Weir door will block the filter canister. You must hold it out of the way when reinstalling the cartridge. When the tub is full of water the door will float so you will have easy access for installing the filter cartridge.
7. Replace strainer basket and skimmer lid.
8. Turn the pump ON.

**Note:** During normal filter maintenance, it will be necessary to occasionally remove oils that coat the filter reducing filter flow. To remove these oils, soak the cartridge in a plastic pail containing a commercial filter cleaning solution (available from your Coleman Spa dealer or most pool supply stores). Follow the manufacturer's instructions for use.

We suggest that you replace your filter cartridge yearly to maintain optimum performance. Filter maintenance depends on usage. Coleman recommends the filter be cleaned once every 90 days at a minimum, more often after heavy use or if water becomes cloudy.

## Draining Spa

Always turn power off to your spa before draining. Immediately after turning the spa back on, lower the temperature setting so the heater will not come on. Keep the heater disabled until you have full flow coming out your jets for several minutes.

The water level in the spa must be kept at its normal level water line mark. **Note:** Evaporation and splashing will cause the water level to drop.

High concentrations of impurities caused by water evaporation, body oils, perfumes, and other contaminants may accumulate in the spa and cannot

be filtered out. Consequently, it is advisable to drain your spa and refill it with fresh water every six to eight weeks or more often, depending on the amount of use.

## Drain Access

All 700 Series spas are equipped with both internal and external drains. The external drain is used when draining and filling your spa for normal water maintenance purposes. The internal drain is used when Winterizing (page 27) your spa.

The external drain is located in the lower part of the front access panel. To use this drain, simply remove the outer black cap, connect a standard garden hose to the fitting, turn the back of the valve counter-clockwise 90°, then pull out to open the valve.

The internal drains are located behind the black pedestal base adjacent to the equipment service panel. To access these drains simply remove the screws holding the access panel on and pull the drain hoses out. Once the drains have been pulled out, remove the caps on the drains, attach a garden hose to the faucets, and open the valves.

**Note:** Do NOT attempt to use the pump to drain the spa.

**Note:** Close and replace caps on all drains prior to refilling spa.

## Priming Spa

Be aware that after draining and refilling your spa you may need to discharge air in the system in order for the pump to operate again. Should you experience an air-lock, you can remove the filter and insert a garden hose into the center hole and flush water through the system.

Warning: Turn off electrical supply before removing cabinet panels.

## Winterizing

In cold climates where freezing temperatures occur, special care is required to prevent the possibility of damage to the spa and equipment due to freezing.

If you plan on using your spa during cold months, be sure your pump and heater are in good working order. The spa shell has been insulated to provide efficient operation in cold weather areas.

**Special Note:** If you do not intend to use your spa during the winter months and there is danger of freezing, the spa must be winterized! You must do the following:

1. Turn off all electrical power to the spa.
2. Drain the spa through all of the drain hoses. Open all unions, and remove drain plugs from bottom of pumps. The drain hoses will not drain off all of the water. You may use a wet-vac to remove the remaining water from the spa. R.V. antifreeze should be added to any remaining water in the spa through the bottom of the skimmer and through the jets. If antifreeze is used, it must be an inhibitor Propylene Glycol such as Dow Frost available through Dow Chemical Distributors.
3. Be sure to drain **all** drain hoses.
4. The filter should be drained, and the cartridge removed and cleaned.
5. Check to see that there is no water in the heater element chamber and plumbing lines. (Loosen unions, pump unions, and drain plug on pump.)
6. Clean your spa as per previous maintenance instructions.
7. Cover your spa with a waterproof, water-shedding, impenetrable cover, such as a tarp.
8. For further information on blowing out the plumbing lines and winterizing procedures, contact your local dealer.
9. If your spa is equipped with the pH sensor option, this sensor must be kept wet at all times. During winterization, remove sensor and reinstall original cap on sensor. The cap should be filled with water.

**Note:** If you elect not to drain your spa and the temperature is going to be below freezing for extended periods of time, especially 0° F (-19.4°C)

and sub zero, it is best to operate the spa heater at high temperature (95°–104°F) (35°–40°C). If the tub is not going to be used and kept in the 100°F (37.7°C) range, you may have problems if your power goes out. It is wise during these bad weather periods to set the thermostat higher. This will keep the spa water from freezing quickly if you have a power failure.

## Light Bulbs

The Spa light bulb is serviceable from outside the spa. You must remove the outer panel and insulation closest to the light. Once the panel is removed, look for the bulb holding bracket and pull bracket towards you to change the bulb.

## Problem Solving Guide

Problem	Usual Cause	Solution
1. System not operating.	A. House circuit breaker tripped or if OFF position.	A. Reset circuit breaker on home breaker panel.
2. Heater not functioning.	A. Water level too low. B. Heater mode not selected. C. No power to heater. D. Thermostat set lower than water E. Heater not operating. F. Flow switch malfunction	A. Add water to reach fill line on Weir door. B. Refer to temperature and heater control instructions on page 11. C. Check house circuit breaker. D. Set to desired temperature. E. Contact dealer. F. Contact dealer
3. Water not clean.	A. Clogged or blocked floor suction or skimmer. B. Filter clogged (dirty). C. Poor water chemistry. D. Insufficient filtering time. E. Improper maintenance. F. High content of solids in water.	A. Clean floor suction/skimmer. B. Clean or replace. C. See "Chemical Treatment" section. D. Run filtration mode longer. E. See maintenance section. F. Use clarifier or drain and refill spa.
4. Abnormal water usage.	A. Excessive evaporation and/or splashing.	A. Use spa cover.
5. Overheating.	A. High ambient temperature B. Direct sunlight, high outdoor temps	A. See page 8, Indoor Installation. B. Move spa into shade, wait for cooler weather
6. Low water flow from jets.	A. Operating in FILTER mode-low speed. B. Clogged or blocked suction or skimmer. C. Dirty filter. D. Jets in off position. E. Diverter Jet in whirlpool position. F. Slice valves closed	A. Select hi-speed jets. B. Clean floor suction/skimmer. C. Clean or replace. D. Open adjustable jets. E. Check Diverter Jet position. F. Open slice valves.

## Problem Solving Guide

Problem	Usual Cause	Solution
7. No water flow from jets.	<ul style="list-style-type: none"> <li>A. Pump not primed.</li> <li>B. House circuit breaker tripped, no power to system.</li> <li>C. Faulty pump or motor.</li> <li>D. Pump surges.</li> <li>E. Jets in off position.</li> <li>F. Slice valves closed.</li> </ul>	<ul style="list-style-type: none"> <li>A. See priming section page 26.</li> <li>B. Reset circuit breaker at home panel.</li> <li>C. Contact dealer.</li> <li>D. Low water. Check level on Weir door.</li> <li>E. Open jets.</li> <li>F. Open slice valves.</li> </ul>
8. Noisy pump and motor.	<ul style="list-style-type: none"> <li>A. Clogged floor suction or skimmer.</li> <li>B. Low water level.</li> <li>C. Damaged or worn motor bearings.</li> </ul>	<ul style="list-style-type: none"> <li>A. Clean floor suction/skimmer.</li> <li>B. Add water to water level on weir door.</li> <li>C. Contact dealer.</li> </ul>
9. Water leakage from under spa.	<ul style="list-style-type: none"> <li>A. Check unions and drain hoses.</li> </ul>	<ul style="list-style-type: none"> <li>A. Tighten unions or drain caps</li> </ul>
10. No air flow from jets.	<ul style="list-style-type: none"> <li>A. Air control not open.</li> <li>B. Jet nozzle not seated properly.</li> <li>C. Jet nozzle missing.</li> </ul>	<ul style="list-style-type: none"> <li>A. Open control.</li> <li>B. Check jet nozzles.</li> <li>C. Inspect jets.</li> </ul>
11. Motor will not operate.	<ul style="list-style-type: none"> <li>A. House circuit breaker tripped or in OFF position.</li> <li>B. Improper or defective wiring or electrical supply.</li> <li>C. Thermal Overload Protection switch tripped.</li> </ul>	<ul style="list-style-type: none"> <li>A. Reset circuit breaker</li> <li>B. Contact dealer.</li> <li>C. Auto reset after motor has cooled. Contact dealer if motor continues to cycle.</li> </ul>
12. The spa will not shut off	<ul style="list-style-type: none"> <li>A. Spa trying to heat</li> <li>B. 700 Series overlapping filter cycles.</li> <li>C. Spa is in filter cycle</li> <li>D. Freeze Protection</li> </ul>	<ul style="list-style-type: none"> <li>A. Check set temperature in Standard mode</li> <li>B. Reset filter times.</li> <li>C. Normal. No need to change.</li> <li>D. Wait for spa to heat to normal temperature</li> </ul>

## Spa Soaking Guidelines

1. Persons with heart disease, diabetes, high or low blood pressure or any serious illness, and pregnant women should not enter a spa without prior consultation with their doctor.
2. People with skin, ear, genital or other body infections, open sores or wounds should not use the spa because of the possibility of spreading infection.
3. Before entering, look at the water in your spa. If there is cloudiness or foaming, or if a strong chlorine smell is present, the water needs treatment. Soaking in such water greatly increases your chances of getting a skin rash (pseudomonas). Be sure to maintain the water properly. Ask your Authorized Coleman Spa Dealer for guidance.
4. Shower with soap and water before and after using the spa. Showering before use washes away many of the common skin bacteria, and removes lotions, deodorants, creams, etc. Perspiration and lotions will reduce the effectiveness of the sanitizer and lessen the ability of the filter to work efficiently.
5. Enter the spa slowly and cautiously. Be careful of your footing, and allow your body to gradually get used to the water temperature. Leave slowly as well, because your leg muscles may be sufficiently relaxed to make you a bit unsteady, and you may become lightheaded.
6. Soaking for too long makes some people nauseous, dizzy, lightheaded or faint. **Don't soak in 104°F (40°C) water for an extended period of time.** If you wish to soak for a longer period of time in high temperatures, leave the spa after 15 minutes, shower, cool down and then return for another brief stay. In lower temperatures (e.g. 98.6°F (37°C)—normal body temperature) most people can comfortably and safely soak for longer periods at one sitting. If you have any questions about what's right for you and your family, consult with your doctor.
7. Be sure you check the water temperature before and while in the spa.
8. Never use the spa while under the influence of alcohol.
9. With any drug or medication, consult with your doctor about potential harmful effects from combined use of the drug and hot water soaking.
10. Never use the spa when you are alone, for safety's sake.
11. Never allow children to use the spa unsupervised.

## Technical Specifications

Structural Features	Model 704TL	Model 705TL	Model 706TL
Western Red Select Cabinet	Vertical	Vertical	Vertical
Dimensions (allow 1/4" variance)	82" x 90 1/4" x 35"	90 1/4" x 92" x 35"	90 1/4" x 92" x 35"
Seating Capacity	4	5	6
Usuable Gallons	320 *	425 *	425 *
Weight in lbs (empty/full)	700 / 3250 *	850 / 4250 *	850 / 4250 *
Electrical Requirements	240V, 30A/50A	240V, 40A/60A	240V, 40A/60A

\* Estimate at time of printing.



# 700 Series Models 705 & 706 Wiring Diagram

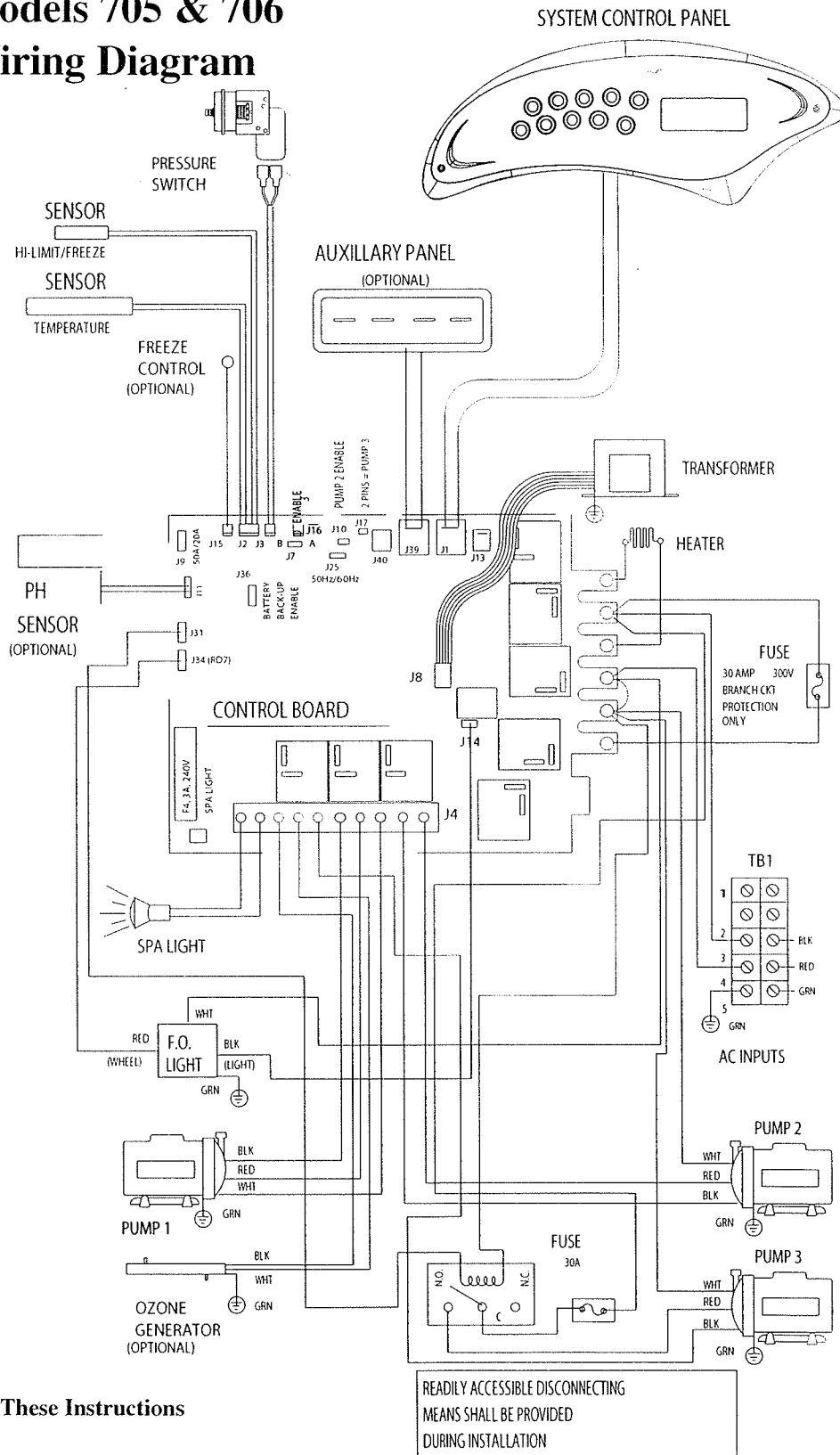

Save These Instructions

# 700 Series Model 704 Wiring Diagram

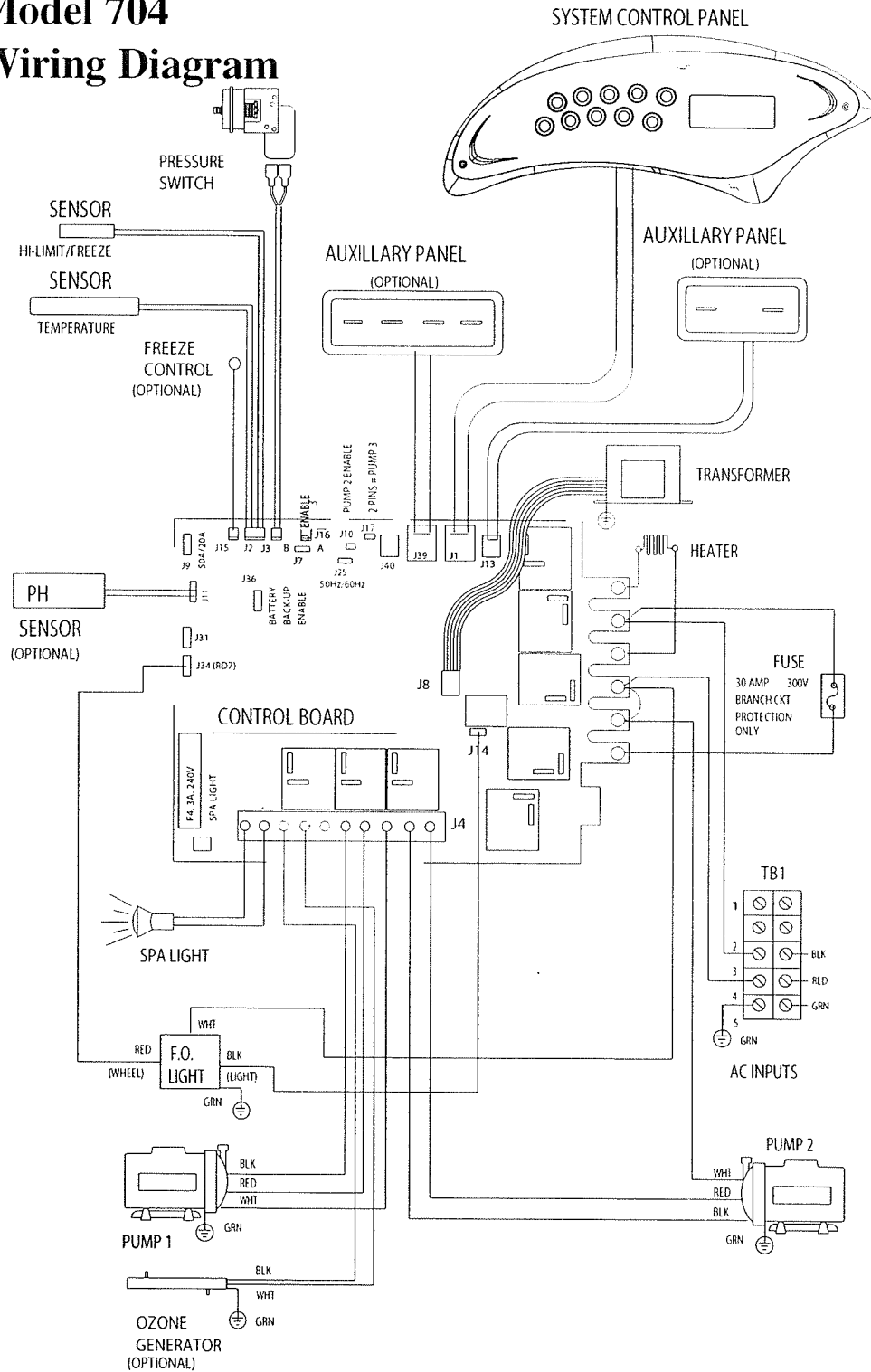

READILY ACCESSIBLE DISCONNECTING MEANS SHALL BE PROVIDED DURING INSTALLATION

Save These Instructions



By MAAX

9501-6209  
Retail Value \$9.95US

25605 South Arizona Avenue, Chandler, Arizona 85248  
©1993-2001MAAX Spas (Arizona), Inc. • Printed in U.S.A.

