

# Swim Spa Operator's Guide

Includes

**Installation, Operation, Maintenance and  
Safety Information**



## **NOTE**

**Read this guide thoroughly. It contains important safety and maintenance information. Please review it and keep it for future reference.**

---

## OWNER'S INFORMATION

### DEALER IMPRINT AREA

### Installer

Company: \_\_\_\_\_

Address: \_\_\_\_\_

Phone: \_\_\_\_\_

Warranty Submitted: \_\_\_\_\_

### PLEASE ASK YOUR DEALER ABOUT REGISTERING YOUR WARRANTY

Model: \_\_\_\_\_

Serial Number: \_\_\_\_\_





Equipment Pack: \_\_\_\_\_

Color: \_\_\_\_\_

Date of Delivery: \_\_\_\_\_

We appreciate your business and our sincere desire is that you receive years of pleasure and therapy from your swim spa. Please call your local spa dealer if you have any questions or problems.

# TABLE OF CONTENTS

<p><b>OWNERS INFORMATION ..... 2-4</b>          Dealer Information          Installors Information          Presidents Letter</p> <p><b>SAFETY INSTRUCTIONS ..... 5-8</b>          Safety Instructions USA          Safety Instructions CANADA</p> <p><b>BASIC INFORMATION ..... 9-10</b>          Do"s and Don"t's</p> <p><b>SET-UP AND DELIVERY ..... 11</b>          Surface and Pad Requirements          Balcony and Decks          Access Clearance          Electrical Requirements</p> <p><b>WIRING DIAGRAM ..... 12-15</b>          XM and XE Requirements          Customer Access Box</p> <p><b>GENERAL PRE-OPERATION ..... 16</b>          Priming Pump</p> <p><b>WIRING DIAGRAM ..... 13</b>          Requirements          Customer Access Box</p> <p><b>CONTROLS AND VALVES ..... 17-18</b>          Air Controls          Mini Controls          Water Diverters          Individual Jets          Water Features          Lighting          Digital Topside          Stereo</p> <p><b>WATER CARE ..... 19-20</b>          Cleaning          Filling          Water Testing          Chemical Use</p>	<p><b>TOPSIDE CONTROLS ..... 21-23</b>          Initial Start-up          Setting The Time          Mode Control          Locking Panel          Temperature</p> <p><b>FILTER LOCATIONS ..... 24-25</b>          Maintenance          Cleaning and Replacing          Enclosed Style Diagram</p> <p><b>BASIC EXERCISE HOOK-UPS ..... 26-27</b>          Exercise Equipment Hook-Up</p> <p><b>SWIM SPA SCHEMATICS ..... 28-35</b>          12'          14'          16'          18'</p> <p><b>DRAINING YOUR SPA ..... 36</b></p> <p><b>WINTERIZING AND START-UP ..... 37</b></p> <p><b>COVER MAINTENANCE ..... 38</b></p> <p><b>TROUBLESHOOTING ..... 39-40</b></p> <p><b>GLOSSARY OF TERMS ..... 41</b></p> <p><b>NOTES/DISCLAIMERS ..... 42-43</b></p> <p><b>This Operator's Guide utilizes the following symbols to emphasize particular information.</b></p> <div style="margin-top: 10px;">  <span style="margin-left: 10px;">The Safety Alert Symbol indicates a potential hazard</span> </div> <div style="margin-top: 10px; background-color: black; color: white; padding: 5px; display: flex; align-items: center;">  <span><b>WARNING</b></span> </div> <div style="margin-top: 10px; background-color: black; color: white; padding: 5px; display: flex; align-items: center;">  <span><b>NOTE</b></span> </div> <div style="margin-top: 10px; background-color: black; color: white; padding: 5px; display: flex; align-items: center;">  <span><b>CAUTION!</b></span> </div>
---	---

Dear Swim Spa Owner:

Congratulations on your purchase of a new swim spa. You now possess the ultimate passport to tranquility - a daily vacation at home, ready and waiting for you in your own backyard!

We want you to enjoy your swim spa. Many hours of research have gone into the design of your swim spa, to ensure the ultimate in hydrotherapy and relaxation. Only the highest quality components have been used, to ensure years of trouble-free operation. Your comfort and enjoyment have been designed into your swim spa from the start.

Please take the time to read through this Operator's Guide. In it, you will find guidelines on caring for your swim spa, a complete explanation of the controls, safety instructions, a trouble-shooting section, and lots more.

Once again, we welcome you to the family of swim spa owners. Your thoughts and ideas are important and we encourage you to share them with us.

Thank you for your business and your confidence in our company.  
We look forward to serving you!

---

## IMPORTANT INSTALLATION INSTRUCTIONS

---

### READ AND FOLLOW ALL INSTRUCTIONS CAREFULLY

#### WARNING

- **Concrete Pad.** The Swim Spa, must be fully supported over the entire base. A typical installation on soil that will support 1,000 psi load, is a 5 inch (13cm) thick concrete with #4 rebar on 18 inch (46cm) centers. Condition at the site will determine the exact support requirements. Please contact your local contractor for adequate installation. Damages caused by inadequate support will not be covered by the warranty. *(Please see page 11 of this manual)*
- **Excess water.** Normal use if the swim spa causes large amounts of water to splash out of the unit. Depending on the specific installation, additional provisions may have to be made for proper removal of this water.
- **Clearance Access:** In order to better service your product, clearance for access to swim spa must be 38 inches (92cm) at equipment compartment and 24 inches (61cm) around the remaining area. *(Please see page 11 of this manual)*

### READ AND FOLLOW ALL INSTRUCTIONS CAREFULLY

#### WARNING

**Installation and use if this equipment requires the user to always follow safety precautions including:**

- **Risk of Accidental Drowning.** Exercise extreme caution to prevent unsupervised children going near the swim spa. Children should not use the swim spa without adult supervision.
- **Risk of Serious Injury or Death.** If you need to replace the suction fitting or pump make sure that the flow rates are compatible. Never operate the swim spa if the suction fittings are broken or missing. Never replace a suction fitting with one rated less than the flow rate marked on the original suction fitting.
- **Risk of Electric Shock.** Install at least 5 feet (1.5m), from all metal surfaces. As an alternative, the swim spa may be installed within feet of metal surfaces if each metal surface is permanently connected by a minimum No. 8 AWG (8.4mm<sup>2</sup>) solid copper conductor attached to the wire connector on the groundlug, inside the equipment compartment on the equipment can.
- **Risk of Electric Shock.** Do not permit any electrical appliances, such a light, telephone, radio, television, etc. within 5 feet (1.5 m) of the swim spa. Never operate any electrical appliances from inside the swim spa or when you are wet.
- **Danger.** The electrical supply for this swim spa must include a suitably rated switch or circuit breaker to open all ungrounded supply conductors to comply with section of the National Electrical Code, ANSI/NFPA 70-1993. The disconnect must be readily accessible and visible to the swim spa occupant but installed at least 5 feet (1.5 m), from the swim spa water.
- **Risk of Electrical shock.** Do not attempt to remove the light housing cover without lowering the water level below the light housing cover.
- **To Reduce the Risk of Injury:** The water in the swim spa should never exceed 104° F (40° C). Water temperatures between 100° F (38° C) and 104° F (40° C) are considered safe for a healthy adult. Lower water temperatures are recommended for young children and when swim spa use exceeds 10 minutes.

---

## IMPORTANT INSTALLATION INSTRUCTIONS cont.

---

### READ AND FOLLOW ALL INSTRUCTIONS CAREFULLY

#### WARNING

- **To Reduce the Risk of Injury.** Since excessive water temperatures have a high potential for causing fetal damage during early months of pregnancy, pregnant or possibly pregnant women should limit swim spa water temperatures to 100° F (38° C).
- **To Reduce the Risk of Injury.** Before entering the swim spa, the user should measure the water temperature with an accurate thermometer since the tolerance of water temperature-regulating devices may vary as much as +/- 5° F (2° C).
- **To Reduce the Risk of Injury:** The use of alcohol, drugs, or medication before or during swim spa use may lead to unconsciousness with the possibility of drowning.
- **To Reduce the Risk of Injury:** Pregnant women, the elderly, infants, or persons suffering from obesity or with a medical history of heart disease, low or high blood pressure, circulatory system problems, or diabetes, should consult a physician before using the swim spa. People with infectious diseases should not use an swim spa.
- **To Reduced the Risk of Injury:** Persons using medications should consult a physician before using the swim spa since some medication may induce drowsiness, while other medication may affect heart rate, blood pressure, and circulation.
- Observe a reasonable time lime when using the swim spa. Long exposures at high temperatures can cause high body temperature (hyperthermia) Enter and exit the swim spa slowly. Wet surfaces can be very slippery.
- Proper chemical maintenance of swim spa water is necessary to maintain safe water and prevent possible damage to swim spa components.
- Use the cover straps and clip tie downs to secure the cover when not in use. This will help discourage unsupervised children from entering the spa and keep the spa cover secure in high wind conditions. There is no guarantee that the cover, clip tie downs, or the actual locks will prevent access to the swim spa.

#### CAUTION!

**HYPERTHERMIA:** Prolonged immersion in hot water may induce hyperthermia. Hyperthermia occurs when the internal temperature of the body reaches a level several degrees above the normal body temperatures of (98.6° F, 37°C). The symptoms of hyperthermia include, dizziness, drowsiness, lethargy, and fainting.

- Failure to feel heat
- Failure to recognize the need to exit the spa
- Unawareness of impending hazards
- Fetal injury in pregnant women
- Physical inability to exit the spa or hot tub
- Unconsciousness resulting in the potential of drowning.

---

# IMPORTANT INSTALLATION INSTRUCTIONS (CANADA)

---

READ AND FOLLOW ALL INSTRUCTIONS CAREFULLY

## WARNING

- A green colored terminal or terminal marked G, GR, Ground, Grounding, or the symbol \* is located inside the supply terminal box or compartment. To reduce the risk of electric supply service panel with a continuous copper wire equivalent in size to the circuit conductors supplying this equipment.
- IEO Publication 417, Symbol 5019.  
At least two lugs marked “Bonding Lugs” are provided on the external surface or on the inside of the supply terminal box/compartment. To reduce the risk of electric shock, connect the local common binding grid in the area of the hot tub or swim spa to these terminals with an insulated or bare copper conductor not smaller than NO. 6 AWG.
- All Field-installed metal components such as rails, ladders, drains or other similar hardware within 3 meters of the swim spa or hot tub shall be bonded to the equipment grounding bus with copper conductors not smaller than No. 6 AWG.
- Children should not use the swim spa or hot tubs with the adult supervision.
- **AVERTISSEMENT: NE PAS LAISSER LES ENFANTS UTILISER UNE CUVE DE RELAXATION SANS SURVEILLANCE.**
- Do not use swim spa or hot tubs unless all suction guards are installed to prevent body and hair entrapment.
- **AVERTISSEMENT: POUR ÉVITER QUE LES CHEVEUX OU UNE PARTIE DU CORPS PUISSENT ÊTRE ASPIRÉS, NE PAS UTILISER UNE CUVE DE RELAXATION SI LES GRILLES DE PRISE D’ASPIRATION NE SONT PAS TOUTES EN PLACE.**
- People using medications and/or having adverse medical history should consult a physician before using an swim spa or hot tub.
- **AVERTISSEMENT: LES PERSONNES QUI PRENNENT DES MÉDICAMENTS OU ONT DES PROBLÈMES DE SANTÉ DEVRAIENT CONSULTER UN MÉDECIN AVANT D’UTILISER UNE CUVE DE RELAXATION.**
- People with infectious diseases should not use a swim spa or hot tub.
- **AVERTISSEMENT: LES PERSONNES ATTEINTES DE MALADIES INFECTIEUSES NE DEVRAIENT PAS UTILISER UNE CUVE DE RELAXATION.**
- To avoid injury, exercise care when entering or exiting the swim spa or hot tub.
- **AVERTISSEMENT: POUR ÉVITER DES BLESSURES, USER DE PRUDENCE EN ENTRANT DANS UNE CUVE DE RELAXATION ET EN SORTANT.**
- Do not use drugs or alcohol before or during the use of the swim spa or hot tub to avoid unconsciousness and possible drowning.
- **AVERTISSEMENT: POUR ÉVITER L’ÉVANOUISSEMENT ET LA NOYADE ÉVENTUELLE, NE PRENDRE NI DROGUE NI ALCOOL AVANT D’UTILISER UNE CUVE DE RELAXATION NI QUAND ON S’Y TROUVE.**
- Pregnant or possibly pregnant women should consult a physician before using an swim spa or hot tub.

---

## IMPORTANT INSTALLATION INSTRUCTIONS (CANADA)

---

READ AND FOLLOW ALL INSTRUCTIONS CAREFULLY

### WARNING

- **ADVERTISSEMENT:** LES FEMMES ENCEINTES, QUE LEUR GROSSESSE SOIT CONFIRMÉE OU NON, DEVRAIENT CONULTER UN M'ÉDECIN AVANT D'UTILISER UNE CUVE DE RELAXATION.
- Water temperature in excess of 38° C may be injurious to your health.
- **ADVERTISSEMENT:** IL PEUT TRES DANGEREUX POUR LA SANT'É DE SE PLONGER DANS DE L'EAU À PLUS DE 38°C.
- Before entertaining the swim spa or hot tub, measure the water temperature with an accurate thermometer.
- **ADVERTISSEMENT:** AVANT D'UTILISER UNE CUVE DE RELAXATION MESURER LA TEMPÉRATURE DE L'EAU À L'AIDE D'UN THERMOMÈTRE PRÉCIS.
- Do not use a swim spa or hot tub immediately following strenuous exercise.
- **ADVERTISSEMENT:** NE PAS UTILISER UNE CUVE DE RELAXATION IMMEDIATEMENT APRÈS UN EXERCICE FATIGANT.
- Prolonged immersion in an swim spa or hot tub may be injurious to our health.
- **ADVERTISSEMENT:** L'UTILISATION PROLONGÉE D'UNE CUVE DE RELAXATION PEUT TRES DANGEREUSE POUR LA SANT'É.
- Do not permit electric appliances (such as a light, telephone, radio, television, etc.) within 1.5m of this swim spa or hot tub.
- **ADVERTISSEMENT:** NE PAS PLACER D'APPAREIL ÉLECTRIQUE (LUMINAIRE, TÉLÉPHONE, RADIO, TÉLÉVISEUR, ETC.) À MOINS DE 1.5 DE CETTE CUVE DE RELAXATION.
- Maintain water chemistry in accordance with manufacturer's instructions.
- **ATTENTION:** LA TENEUR DE L'EAU EN MATIÈRES DISSOUTES DOIT ÊTRE CONFORME AUX DIRECTIVES DU FABRICANT.
- The use of alcohol or drugs can greatly increase the risk of fatal hyperthermia in hot tubs and swim spas.
- **ADVERTISSEMENT:** LA CONSOMMATION D'ALCOOL OU DE DROGUE AUGMENTE CONSIDÉRABLEMENT LES RISQUES D'HYPERTHERMIE MORTELLE DANS UNE CUVE DE RELAXATION.

**SAVE THESE INSTRUCTIONS**



---

## BASIC INFORMATION

---

Congratulations on the purchase of your new spa. Our goal is to provide you with a warm and relaxing spa which incorporates a soothing water massage. In order to maximize the pleasure of your spa, you will need to understand how it works.

The following operating and maintenance instructions are very important and must be followed carefully. With proper care and maintenance your spa will provide you with years of satisfaction with minimum effort.

- The pump and heater should be operated a minimum of two hours per day for cleaning and heating.
- The length of time required to heat your spa to the desired water temperature will vary, depending on the air temperature, season, and wind velocity. We highly recommend using a vinyl hard cover to minimize heat loss and to protect your spa when not in use. Covers are available from your local Spa dealer.
- The replaceable filter cartridge is trouble free and easy to clean. A routine cleaning is the best practice. Make sure the pump is off, then remove the cartridge. Wash it off using a water hose with a pressure nozzle and then reassemble. This should be done on a monthly basis.
- Keep the spa water level 2" (5cm) above the skimmer. Never allow the water level to drop below the bottom of the skimmer opening. If the water level is too low, the skimmer will allow air into the water lines of the pump, causing it to lose its prime (water flow). Running the pump without water flow will damage the pump seal assembly and could possibly result in further equipment damage, which will not be covered under warranty.
- If your spa has a natural wood skirt or if you purchased a gazebo, we recommend applying a wood sealer of your choice (always follow application instructions) to protect the finish. Repeat as directions suggest.
- You should clean your spa at least every 3-4 months. Drain the spa water and use a gentle liquid cleanser. DO NOT use hard brushes or abrasive cleaners. Fill with regular tap water and chemically treat the water for a clean and healthy spa.

### CAUTION!

**CAUTION: Cover must be kept on spa at all times when spa is drained or winterized. Direct exposure to sunlight can damage plastic parts and interior surface, jets, or any interior components. Damage caused by exposure to the sun will not be covered under warranty.**

### WARNING!

**Do not use soft water. It may harm your acrylic.**

# SAFETY DO'S AND DONT'S / DANGER SIGN

## DO

- DO read all operating instructions.
- DO read, understand and follow all safety, danger and warning instructions before use.
- DO test water temperature with your hand before entering.
- DO keep the cover down when the swim spa remains unused.

## DO NOT

- DO NOT block or sit on the filter recess area.
- DO NOT allow horseplay or unsupervised use of your swim spa.
- DO NOT allow anyone to tamper or play with any of the safety or suction fittings of your swim spa.

## DANGER SIGN

Every swim spa has a warning sign that outlines safety precautions. Read and familiarize yourself with all warnings listed on this sign. Make the sign visible and accessible to all swim spa users.

Replacement signs may be obtained from our Media Department:  
[mediaservices@dynastyspas.com](mailto:mediaservices@dynastyspas.com)

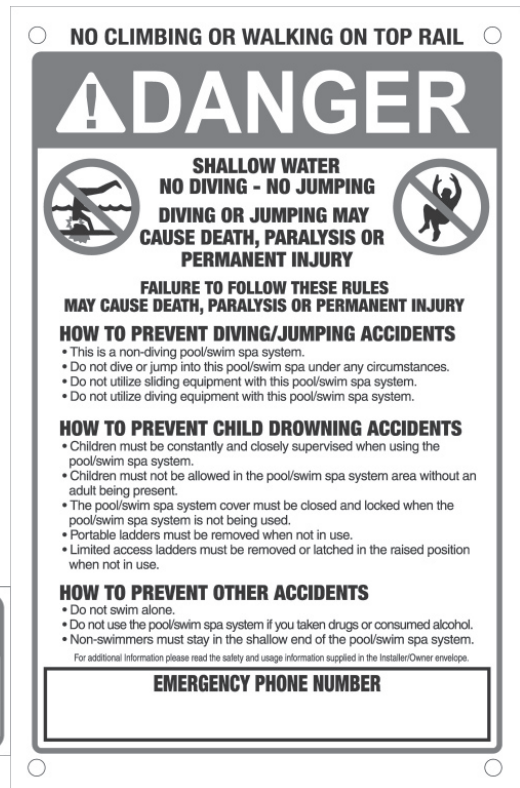

---

# SET-UP & DELIVERY GUIDELINES

---

## Getting Ready For Delivery & Set-up Of Your New Spa

### Surface And Pad Requirements

- The Swim Spa, must be fully supported over the entire base. A typical installation on soil that will support 1,000 psi load, is a 5 inch (13cm) thick concrete with #4 rebar on 18 inch (46cm) centers. Condition at the site will determine the exact support requirements. Please contact your local contractor for adequate installation. Damages caused by inadequate support will not be covered by the warranty.
- If your spa is located near sprinklers, adjust or cap them so they do not hit the siding of the spa.

### Balconies And Deck Requirements

- **Do NOT place any swim spa on any deck or balconies.**
- Gates must be self-closing and self-latching.

### Access & Clearance

- Your spa requires 42" (106cm) of clearance through gates between house and side fences, and up to 8.5' (3m) overhead clearance depending on the size of the unit.
- The clearance required to turn a corner can be equal to the length of the spa.
- All debris blocking access to the job site must be removed prior to delivery. Any trimming of trees or bushes, removal of debris, leveling of ground or other general maintenance must be done prior to delivery and is the responsibility of the customer.

### Electrical Requirements

- Your 220 Volt spa pack will require a double pole 60 amp dedicated GFCI (unless noted for your setup), ground fault circuit breaker.
- Extension cords are not to be used in conjunction with operation of the spa. Low voltage damage could result, which is not covered by warranty.
- If you have any doubts, have your electrical system checked by a licensed electrician.

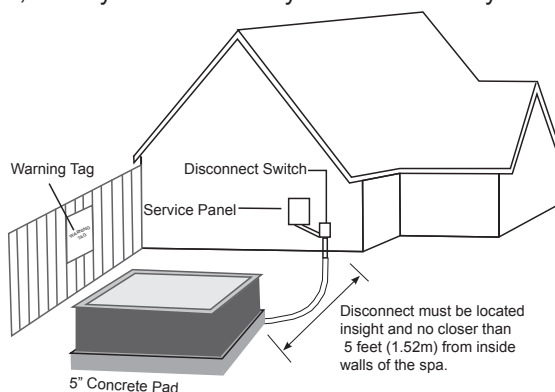

### **NOTE!**

**It is the customer's responsibility to acquire necessary permits and to arrange for installation and hook up of the electrical power by a licensed electrician.**

# (XM) WIRING DIAGRAM - 12'

THE DIAGRAM IS INTENDED FOR THE XM PACK SYSTEM

## Wiring Requirements

- 2-Hots, 1-Neutral, 1-Isolated Ground
  - 0-40' length, 4 Wire #6 AWG minimum 75°C copper conductor
  - Over 40' length, 4 Wire #6 AWG minimum 75°C copper conductor
- (Check your local Electrical codes for 60 Amp GFCI circuits for correct wire size for some areas vary)

## Factory Recommended G.F.C.I. Load Center Wiring



**Note: The white neutral wire from the back of the GFCI MUST be connected to an incoming line neutral. The internal mechanism of the GFCI requires this neutral connection. The GFCI will not work without it.**

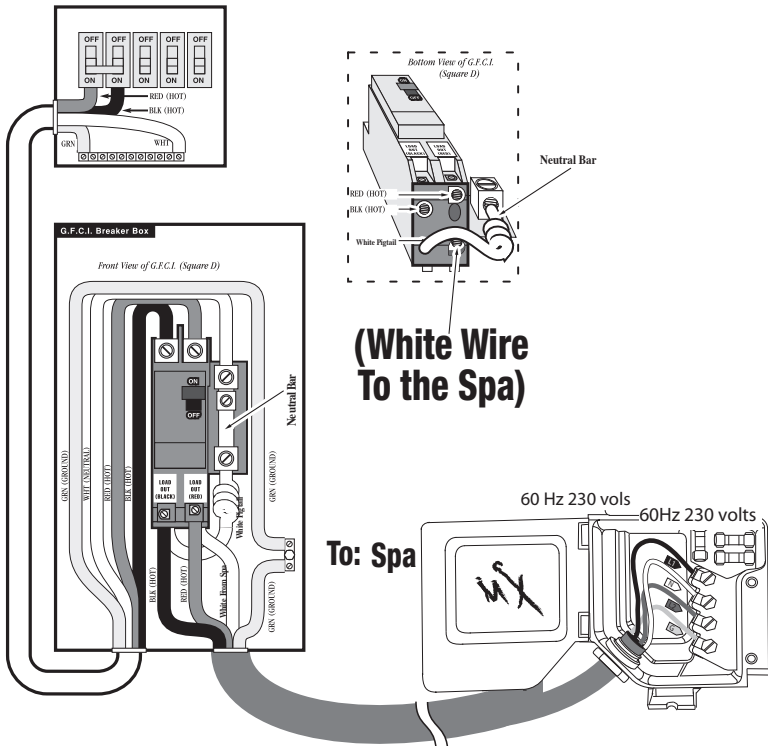

**Note: Connection order may vary by pack model, please refer to equipment pack panel for proper connection order.**

# (XM) WIRING DIAGRAM - 12'

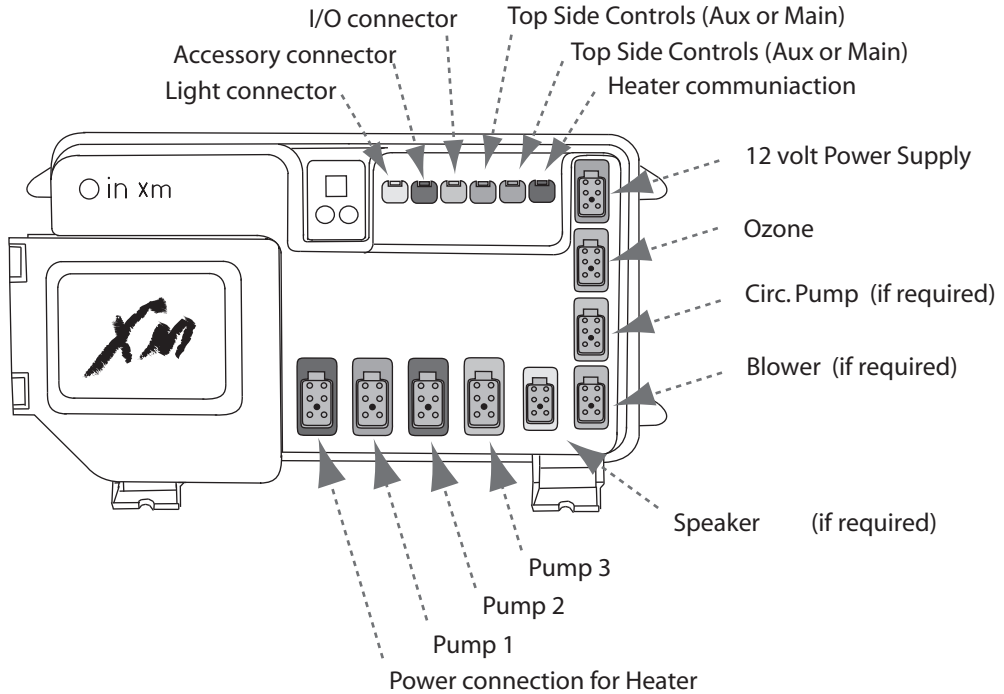

# (XE) WIRING DIAGRAM - 14', 16', 18'

THE DIAGRAM IS INTENDED FOR THE XE PACK SYSTEM

## Wiring Requirements

- 2-Hots, 1-Neutral, 1-Isolated Ground
  - 0-40' length, 4 Wire #6 AWG minimum 75°C copper conductor
  - Over 40' length, 4 Wire #6 AWG minimum 75°C copper conductor
- (Check your local Electrical codes for 60 Amp GFCI circuits for correct wire size for some areas vary)

## Factory Recommended G.F.C.I. Load Center Wiring

### ⚠ NOTE!

**Note: The white neutral wire from the back of the GFCI MUST be connected to an incoming line neutral. The internal mechanism of the GFCI requires this neutral connection. The GFCI will not work without it.**

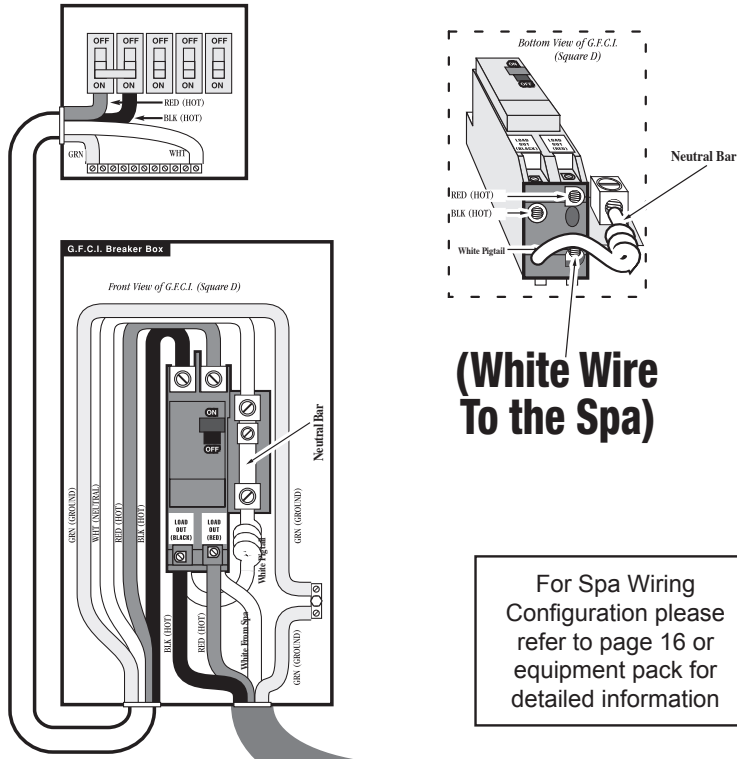

### ⚠ NOTE!

**Note: Connection order may vary by pack model, please refer to equipment pack panel for proper connection order.**

---

## (XE) WIRING DIAGRAM - 14', 16', 18'

---

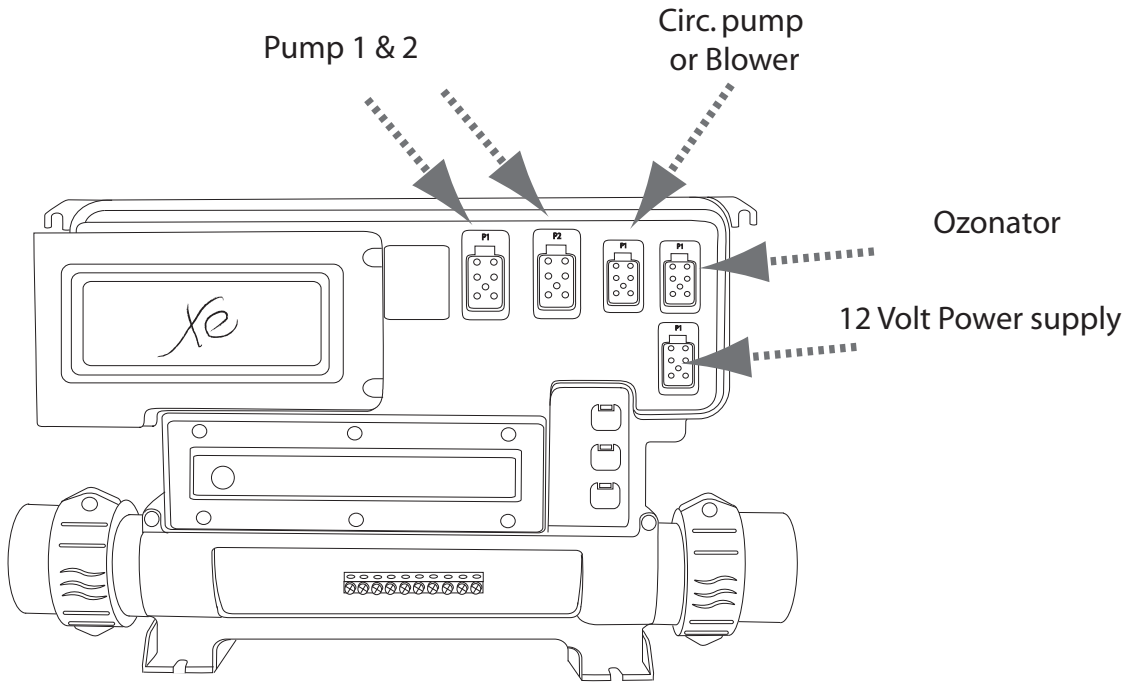

230 VOLT 60HZ/most common

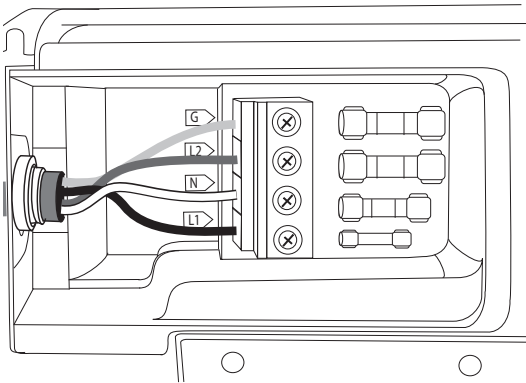

# GENERAL PRE-OPERATION INSTRUCTIONS

## Priming Pump For Electric Packs

The Power pack system is located under the skirting. The equipment can be serviced by simply removing the door. The door is located on the side of the spa where three panels are located, usually on the side of the spa with the lounger, or the side where the topside control panel is located.

It is important to make sure that all of the air is out of the pump(s) before operating. To do this follow procedures below:

- Turn off power at the breaker
- Make sure the gate valves are open
- Fill the spa with water going thru the filter
- Turn the power on at the breaker
- Start the pump on low speed and water should start circulating within one to two minutes. If water does not start circulating, turn pump from low to high until prime is picked up.
- If pump still does not prime, please see “Trouble Shooting Guide” located in the back of this manual

### **NOTE!**

**Note: Equipment style and location will vary by model**

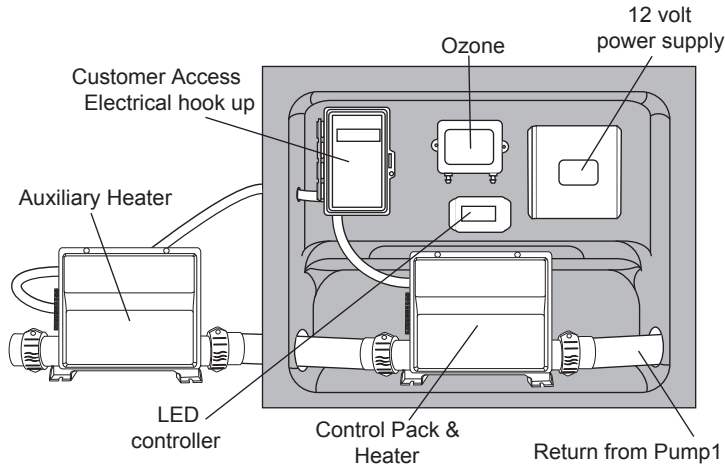

*Set thermostat, located on top side control panel, to desired temperature and continue heating until desired temperature has been reached. Depending on equipment, this will normally take 8 to 10 hours.*

### **WARNING!**

**WARNING: Do not run spa with gate valves closed or run pump with no water circulating in spa for long periods. This could damage the spa equipment.**



---

## CONTROLS AND VALVES

---

### Air Control

Each spa is equipped with air controls (venturies). The purpose of these controls is to regulate the mixture of air and water that flows through the jets. If an optional blower is installed, air is also pushed through the air controls (venturies) for maximum output. If your spa has a master massage jet located in the foot well, the spa will be equipped with an air control specifically for the master massage jet. This third control operates the same as the others. Colors/style may vary from drawing. An Air Control is the smallest of the valve controls.



### Mini Diverter Valve

This valve controls the water flow of neck jets, shoulder jets, and waterfalls (if so equipped) located throughout the spa. A simple clockwise turn of the handle will increase to the maximum output allowed. Another turn in the opposite direction will decrease / turn off the jet. Colors/style may vary from drawing. A Mini Diverter Valve is the medium size of the valve controls.



### Water Diverter Valve

The Water Diverter Valve controls the output of the pump(s) water flow to either side of the spa, or it will provide even water flow to all jets if left in the half way position. The purpose of this valve is to increase or decrease the output of one side or another for maximum or minimum water flow in case of one or two person usage. This valve is also used to turn the master massage jet on and off, if so equipped. Colors/style may vary from drawing. A Water Diverter Valve is the largest of the valve controls.



Although all three controls look similar in appearance, they are easily discernable by size. The Air Control is the smallest, the Mini Diverter Valve is medium in size, and the Water Diverter Valve is the largest .



### NOTE!

**A Mini Diverter Valve, an Air Control, and a Water Diverter Valve. Locations will vary on each spa model.**

---

## OTHER GENERAL CONTROLS

---

### **Individual Jet Operation**

Individual jets can be turned on and off. This is done by simply turning the outer jet housing. Turning clockwise will turn the jet on, and turning counterclockwise will turn the jet off. Individual jet control can be done independently from normal diverter valve settings.

### **Water feature Control**

All spas are equipped with water features, they are controlled with a Mini Diverter Valve. Turning the Mini Diverter Valve full clockwise will turn the waterfall on full power, while turning full counterclockwise will turn the waterfall off.

### **Lighting Control**

Your spa may be equipped with lighting. If so, please refer to the “Quick Reference Card” located on page 21.

### **Digital Top Side Control Panel Instructions**

Exclusive digital top side control system. When you are ready to program your spa, please consult the “Quick Reference Card” located on page 21. It has specific instructions for your particular spa’s unique features and controls.

### **Stereo Controls**

If your spa is equipped with an optional stereo system, please refer to your Stereo Owner’s Manual located inside your stereo equipment area, or included with your spa’s documentation.

---

## WATER CARE

---

### Cleaning Your Spa Water

You need to keep your spa clean and ready to use. When you enter your spa, you bring in as much contamination as 50 people would in a normal size swimming pool! Because your spa is such a small, enclosed environment, it needs to be a sanitary place. We accomplish this with a simple three step process:

- 1) Balance
- 2) Filtration
- 3) Sanitation

The water that comes from your tap at home is fine for showers or bathing, because it is drained immediately after use. In a spa, your water is used for up to three months. Hot water is a breeding ground for bacteria, so sanitizing becomes necessary, as well as maintaining a specific mineral balance. Having that mineral balance in place ensures that the water, which is naturally corrosive to metal, will not cause damage to the spa equipment. We recommend weekly water testing.

**WARNING: Maintain water chemistry in accordance with manufacturer's instructions.**

**WARNING: Please be careful with chemicals - damage to the surface of the spa can occur due to the improper use of chemicals such as trichlor or chlorine, chemical tablets, acids or spa cleaners. Do not let undissolved chemicals lie on the surface of the spa. Damage from chemical misuse is not covered under warranty. Improper water chemistry balance can damage the spa surfaces and/or equipment, and is not covered under your warranty.**

### Filling Spa With Water

When filling the spa, use 2 ounces of SODIUM BROMIDE to create a bromide reserve. When using BROMINATING TABLETS in a floating dispenser, two to three tablets will treat up to 500 gallons (1893 Liters) of water. For a chlorine system, use CHLORINATING GRANULES (1/2 oz. per 500 gallons) (1893 Liters).

Once the spa has been filled to the correct level and pumps are primed and running add:

- 1) STAIN & SCALE REMOVER- This prevents staining, rust and corrosion, caused by metals in the source water. One bottle will treat up to 500 gallons for up to 3 months.
- 2) CALCIUM BOOSTER (If Needed) - Calcium booster treats the water if low calcium hardness is a problem in your area. It will help prevent equipment corrosion and foaming by raising the spa's water hardness level to an acceptable range of 120 ppm.
- 3) pH STABILIZER - It will properly adjust and hold the pH for up to 3 months.

### Water Testing

Your Spa Dealer is equipped to perform a thorough analysis of your spa water. Take a one liter sample to the store and they will advise you on the products necessary to properly balance and care for your spa. Unbalanced spa water can quickly damage your equipment. Your Spa Dealer will advise you on how to protect your investment.

---

## WATER CARE

---

### **Balance**

Spa water must have the correct chemical balance. Unbalanced water can irritate eyes, corrode the equipment, leave mineral deposits, and decrease the effectiveness of the sanitizer. Balanced water means establishing proper balance among Total Alkalinity, pH, Calcium Hardness and Total dissolved solids.

### **(An Overview)**

### **Monthly - For Equipment Protection**

**CALCIUM BOOSTER** (If Needed) - Calcium booster treats the water if low calcium hardness is a problem in your area. It will help prevent equipment corrosion and foaming by raising the spa's water hardness level to an acceptable range of 120 ppm.

### **Filter Cleaning**

Keep your filter free of grease, grime, and oil. Clean the filter with **SPA CARTRIDGE FILTER CLEAN**. One 16 oz. bottle treats a 55' filter (1525cm). See Filter Maintenance section for location and diagram.

### **As Needed**

#### **Surface Cleaning**

Between refills and as needed, clean the surface using **SPA MULTI-PURPOSE CLEANER**. For tough scale & stains, use **STAIN & SCALE REMOVER**.

#### **Surface Protection**

To protect and seal the spa surface, use **SPA FAST GLOSS** every time you drain and clean the spa.

#### **Water Balance**

Adjust the pH quickly and easily with **pH STABILIZER**. It will properly adjust and hold the pH for up to 3 months. Note: Not recommended for calcium hardness levels above 200 ppm. Use **SPA UP** to raise pH and **SPA DOWN** to lower pH.

#### **Sanitizing**

Use 2 ounces of **SODIUM BROMIDE** to create a bromide reserve. When using **BROMINATING TABLETS** in a floating basket, two to three tablets will treat up to 500 gallons (1893 Liters) of water. For a chlorine system, use **CHLORINATING GRANULES** (1/2 oz. per 500 gallons) (1893 Liters).

#### **Mineral Protection**

**STAIN & SCALE REMOVER** - This prevents staining, rust and corrosion, caused by metals in the source water. One bottle will treat up to 500 gallons (1893 Liters) for up to 3 months.

#### **Foam Control**

To control foaming, use **SPA FOAM DOWN**. For added convenience, use just 3 drops of **SPA FOAM DOWN CONCENTRATE**.

#### **Skin Conditioning**

To prevent dry skin, pour **SKIN SOFTENER** directly into the spa. It soothes and moisturizes.

#### **Algae Control**

For spas with green or yellow algae, use **SPA ALGAECIDE** to kill and prevent further algae growth.

## K450 CONTROLS - 12' & 14'

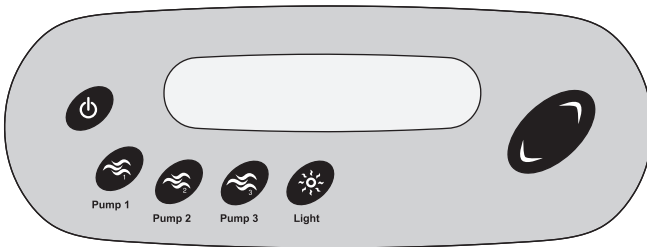

3 Pump Systems if Equipped (applies to the 12' and 14')

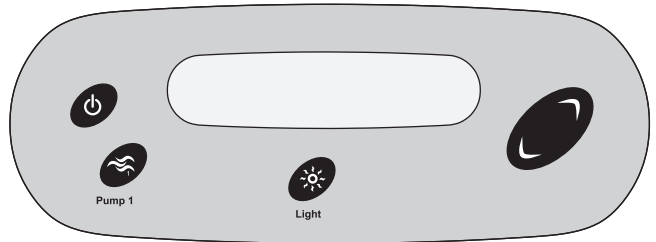

1 Pump System if Equipped (applies to the 18')



Pump 1

Press **Pump 1** key to turn on **Pump 1** on at a low speed. Press **Pump 1** key a second time to turn pump on at a higher speed. Press **Pump 1** three times to turn pump off.



Pump 2

Press **Pump 2** key to turn on **Pump 2** on at a low speed. Press **Pump 2** key a second time to turn pump on at a higher speed. Press **Pump 1** three times to turn pump off. (if equipped)



Pump 3

Press **Pump 3** key to turn on **Pump 3** on at a low speed. Press **Pump 3** key a second time to turn pump on at a higher speed. Press **Pump 3** three times to turn pump off. (if equipped)



Light

Press **Light** Key to turn light on. Press light key a second time to turn off.



Up

Use the **Up** or **Down** key to set desired water temperature.

The “Set Point” icon indicates that the display shows the desired temperature, NOT the current temperature.



Down

## K85 4 PUMP CONTROLS - 16' & 18'

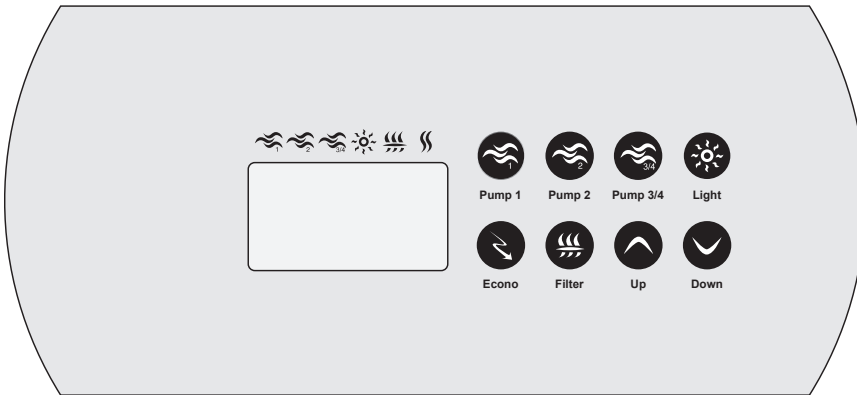

*(applies to the 16' and 18')*



Pump 1

Press **Pump 1** key to turn on **Pump 1** on at a low speed. Press **Pump 1** key a second time to turn pump on at a higher speed. Press **Pump 1** three times to turn pump off.



Pump 2

Press **Pump 2** key to turn on **Pump 2** on at a low speed. Press **Pump 2** key a second time to turn pump on at a higher speed. Press **Pump 1** three times to turn pump off.



Pump 3/4

Press **Pump 3/4** key to turn on **Pump 3/4** on at a low speed. Press **Pump 3/4** key a second time to turn pump on at a higher speed. Press **Pump 3/4** three times to turn pump off.



Filter

A quick press of the **Filter** key will allow you to display the clock. A long press of 5 seconds will allow you to enter the program menu, as in the filter cycles, set the clock, etc.



Light

Press **Light** Key to turn light on. Press light key a second time to turn off.



Econo

Press **Econo** Key to switch from normal mode to economy mode. To save energy, the economy mode set point is 20°F (11°C) below the normal mode set point.



Up

Use the **Up** or **Down** key to set desired water temperature.

The “Set Point” icon indicates that the display shows the desired temperature, NOT the current temperature.



Down

---

## K100 CONTROLS (SPA END) - 16' & 18'

---

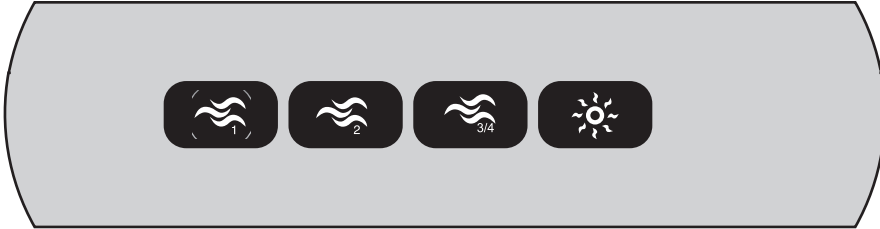

*(applies to the 16' and 18')*



Pump 1

Press **Pump 1** key to turn on **Pump 1** on at a low speed. Press **Pump 1** key a second time to turn pump on at a higher speed. Press **Pump 1** three times to turn pump off.



Pump 2

Press **Pump 2** key to turn on **Pump 2** on at a low speed. Press **Pump 2** key a second time to turn pump on at a higher speed. Press **Pump 1** three times to turn pump off. (if equipped)



Pump 3/4

Press **Pump 3/4** key to turn on **Pump 3**. Press **Pump 3/4** key a second time to turn **Pump 4**. Press **Pump 3/4** three times to turn off **Pump 3**. Press **Pump 3/4** four times to turn off **Pump 4**.(if equipped)



Light

Press **Light** Key to turn light on. Press light key a second time to turn off.

# FILTER LOCATION

## Enclosed Filter Location

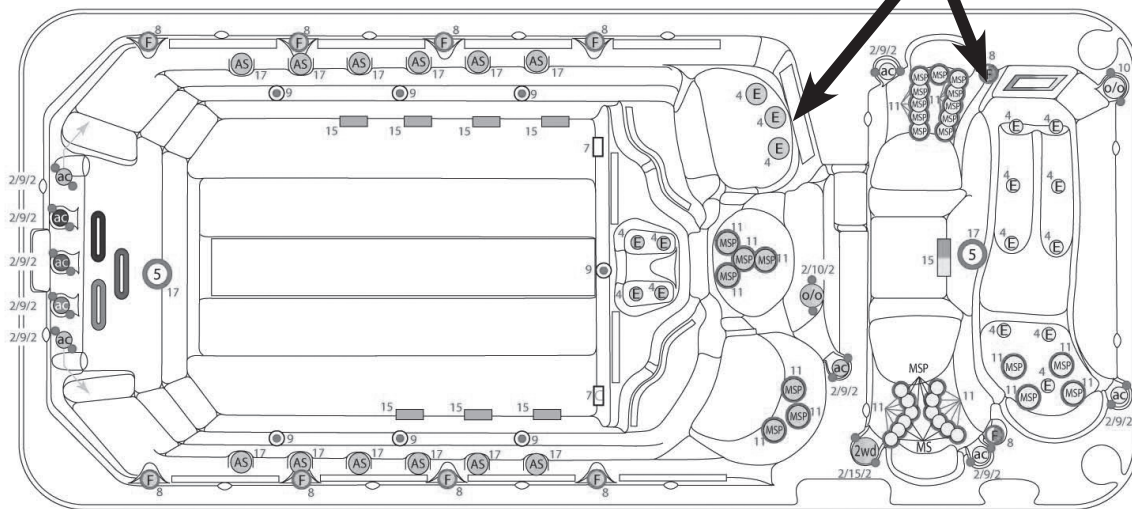

### Enclosed Style

- Turn off power at the breaker.
- Pull the top floating weir assembly out exposing the filter.
- Unscrew filter cartridge(s) and remove.
- Clean with a garden hose equipped with a high pressure nozzle, or soak in filter cartridge cleaner if necessary, or at every other regularly scheduled cleaning. Rinse filter thoroughly before installing.
- Screw clean cartridge back into filter enclosure and return filter door to original position.

### NOTE!

**Note: The filter should be inspected and cleaned on a monthly basis.**



---

# FILTER LOCATION

---

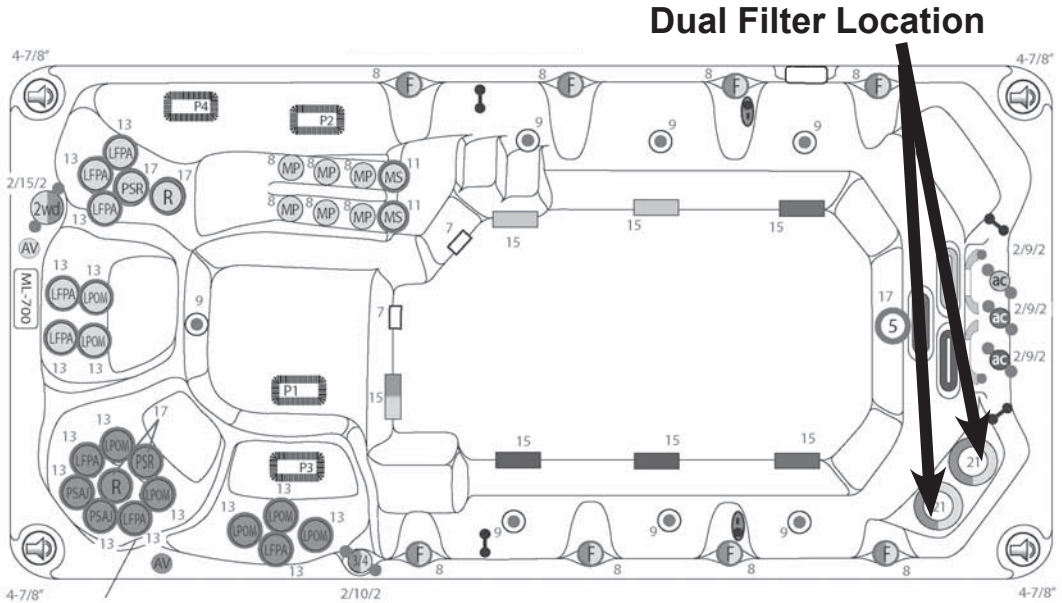

## Filter Maintenance

Filtration starts as soon as water flow is steady through the filter. The filter cartridge removes body oil and debris from the spa water, as they can cause flow resistance. A dirty cartridge will decrease flow and may prevent the spa from heating properly. Therefore, regular filter cleaning is essential.

## Cleaning and Replacing Filter Cartridge

Your spa filter(s) have been designed for quick and easy maintenance.



### NOTE!

**Note:** The filter location may vary.

# EXERCISE EQUIPMENT INSTALLATION

## Swim Spa Exercise Equipment



1 - Zipper Bag



2 - 10" Bands

2 - 10 1/2" Bands

2 - 56 1/2" Bands



2 - Hand Grips

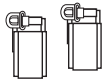

2 - Ankle Straps

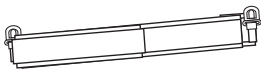

1 - Waist Band

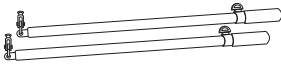

2 - Oars

Please refer to Drawing

# EXERCISE SCHEMATIC

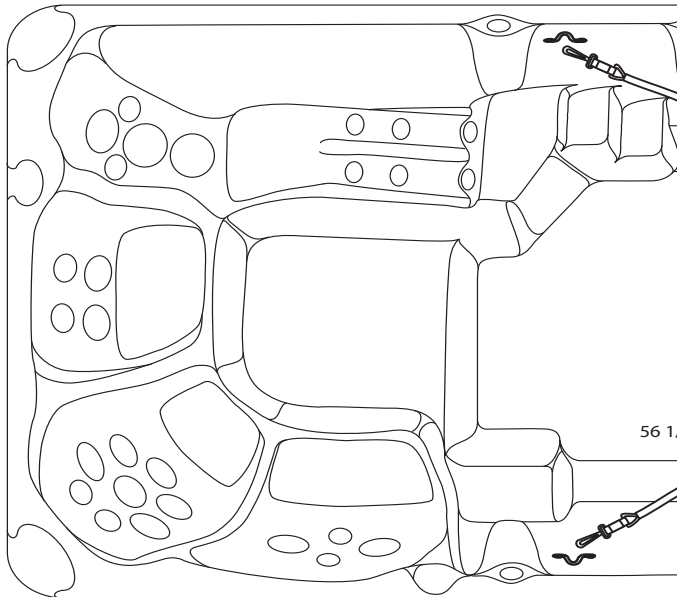
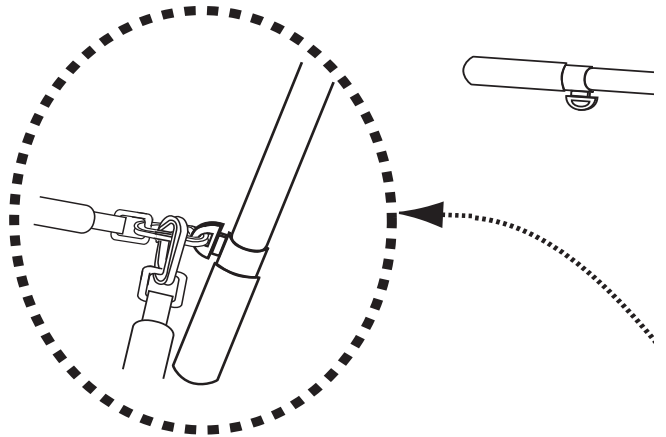

### ⚠ NOTE!

THIS EXERCISE EQUIPMENT APPLIES TO THE HOOK-UP OF THE 16' AND 18' SWIM SPA.

## EXERCISE SCHEMATIC

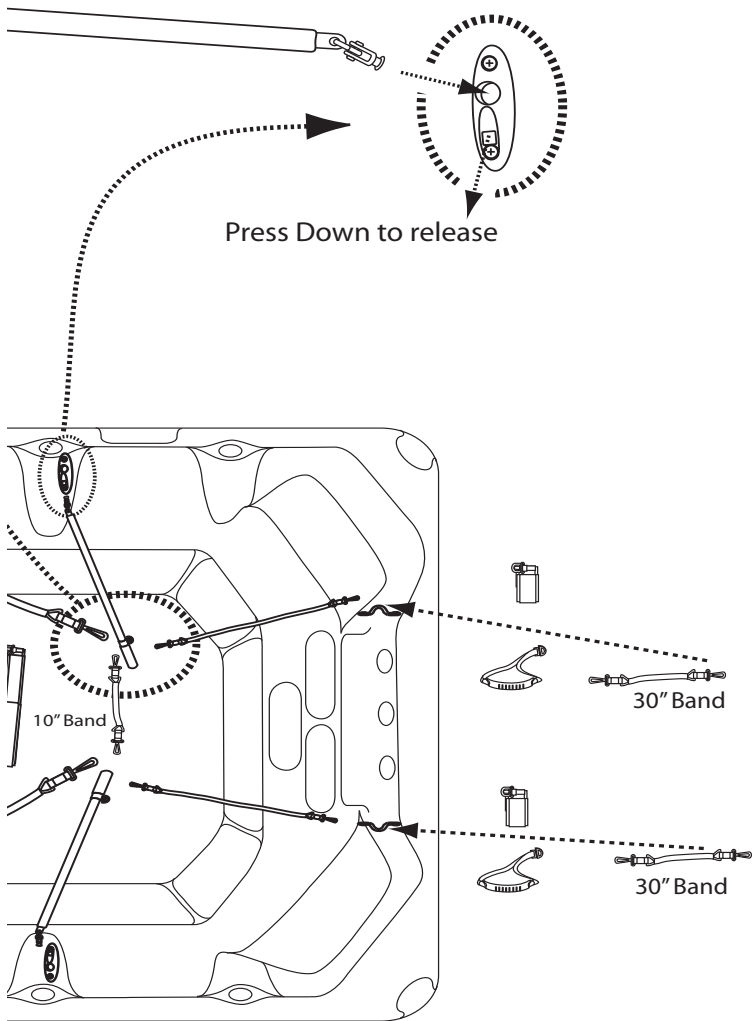

## WARNING SIGNS

### DANGER SIGN

Every swim spa has a warning sign that outlines safety precautions. Read and familiarize yourself with all warnings listed on this sign. Make the sign visible and accessible to all swim spa users.

Replacement signs may be obtained from our Media Department:  
[mediaservices@dynastysp.com](mailto:mediaservices@dynastysp.com)

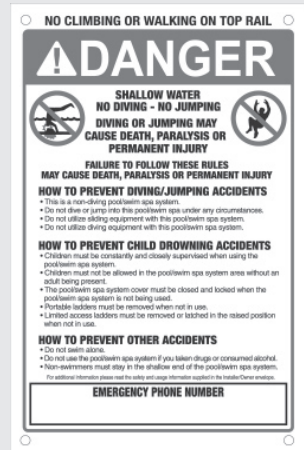

### NOTE!





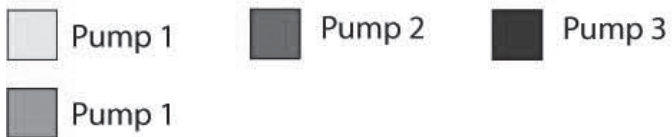
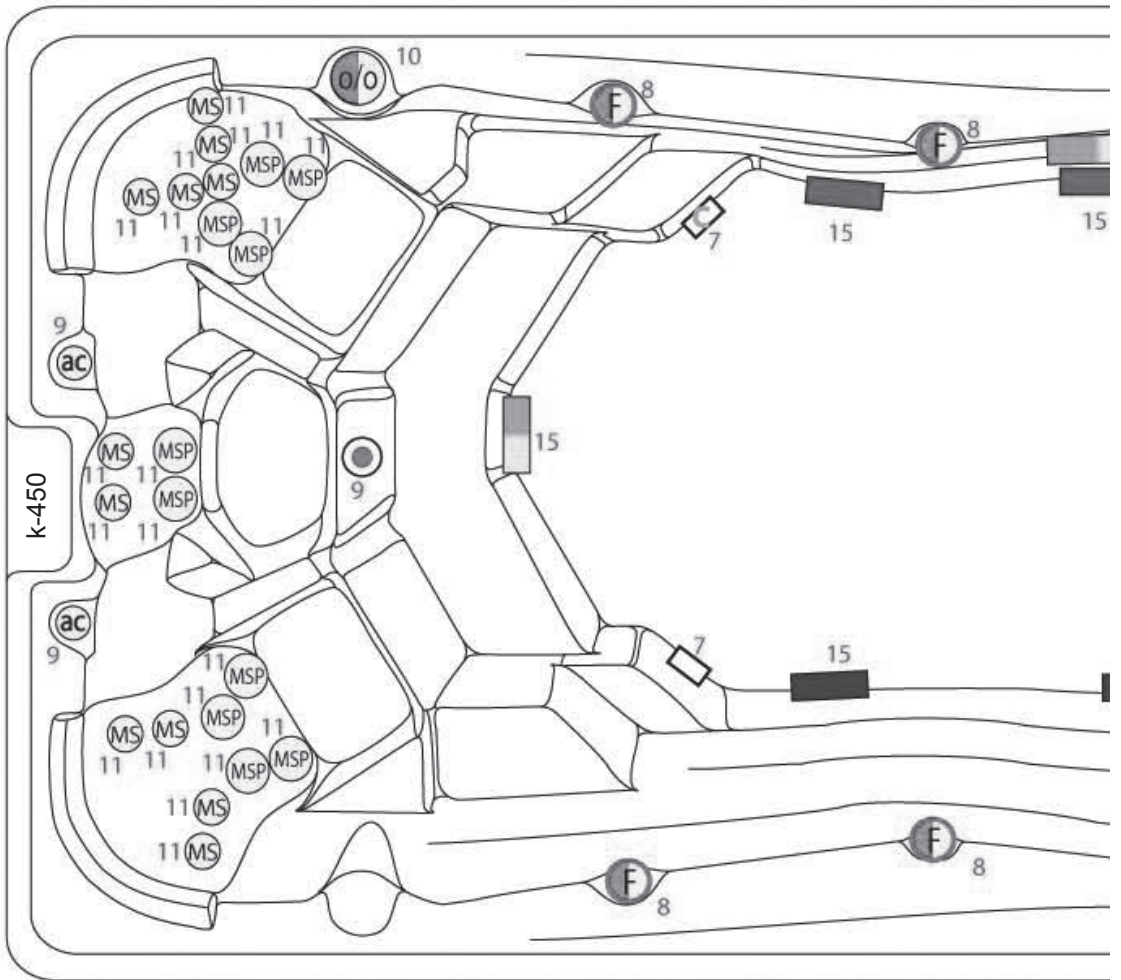



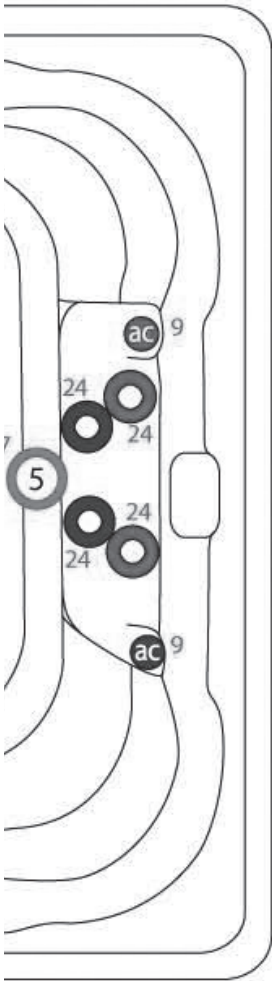











DRAWING MAY VARY - MANUFACTURER HAS RESERVED RIGHTS FOR ANY CHANGES OR MODIFICATIONS.

# 12' SWIM SPA SCHEMATIC



# 12' SWIM SPA SCHEMATIC



 8	 Water Feature
 11	 Mini Storm Directional
 11	 Mini Storm Spinner
 17	 5" LED Light
 7	 Drain
 15	 Suction
 10	 3/4" On / Off Valve
 9	 Air control
 24	 Whirl Pool Jet
 9	 2" LED Light

**NOTE!**

DRAWING MAY VARY - MANUFACTURER HAS RESERVED RIGHTS FOR ANY CHANGES OR MODIFICATIONS.

# 14' SWIM SPA SCHEMATIC

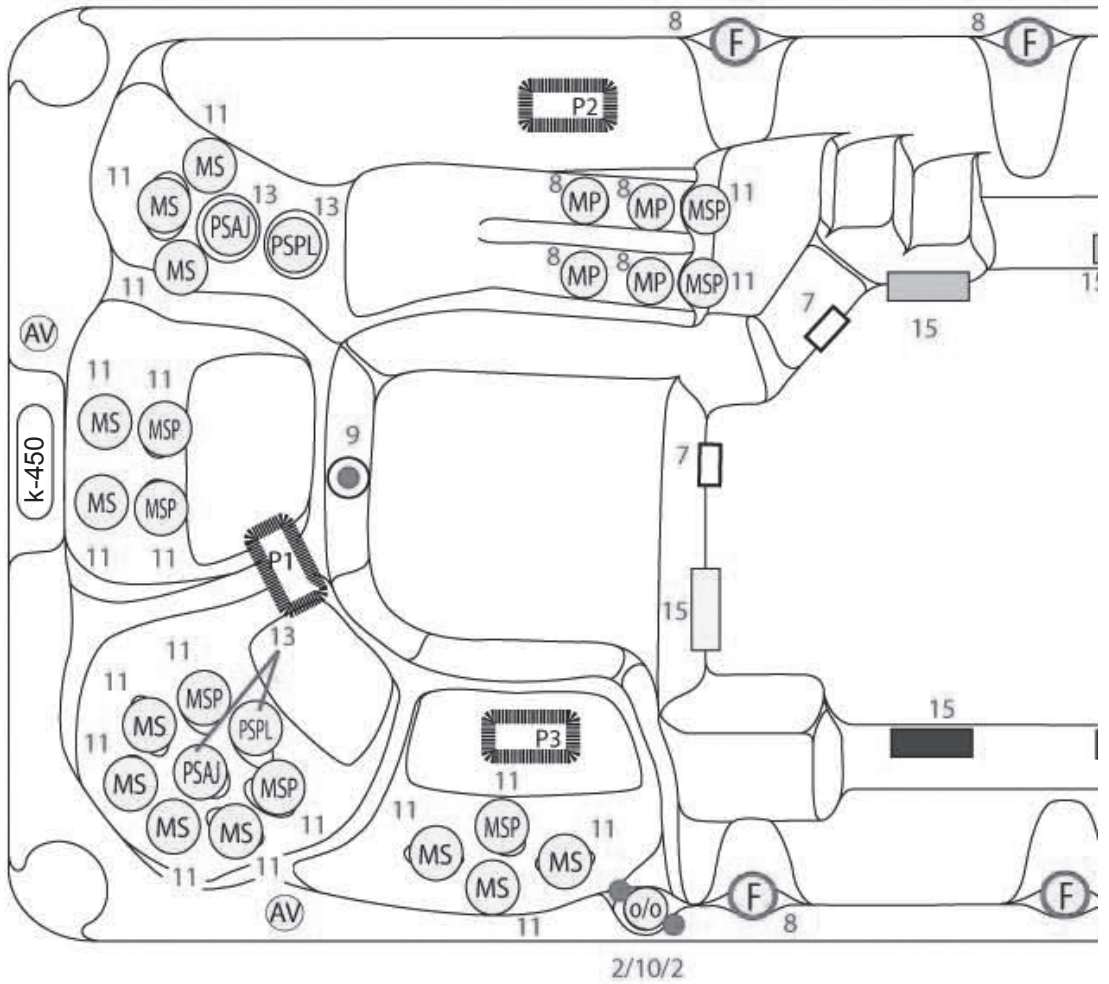

# 14' SWIM SPA SCHEMATIC

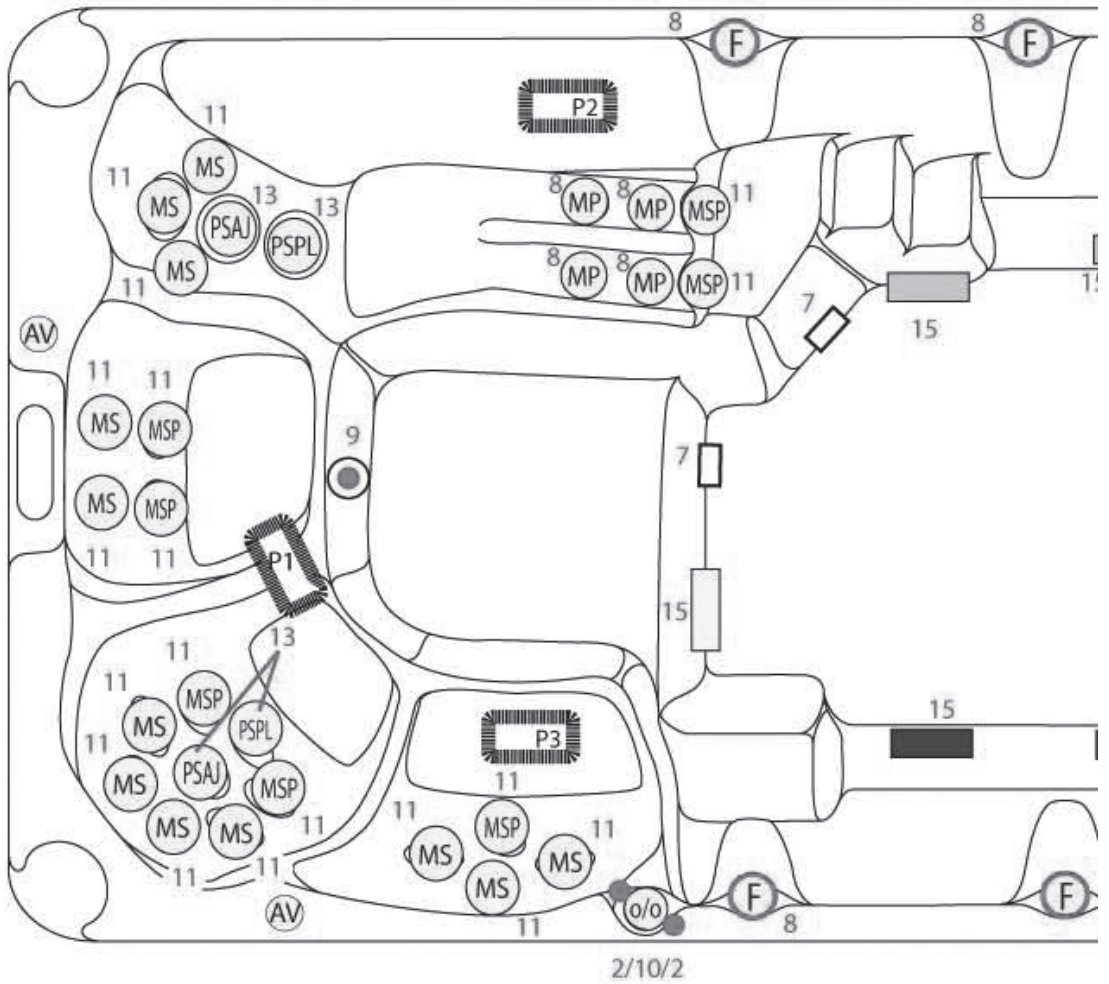



# 14' SWIM SPA SCHEMATIC

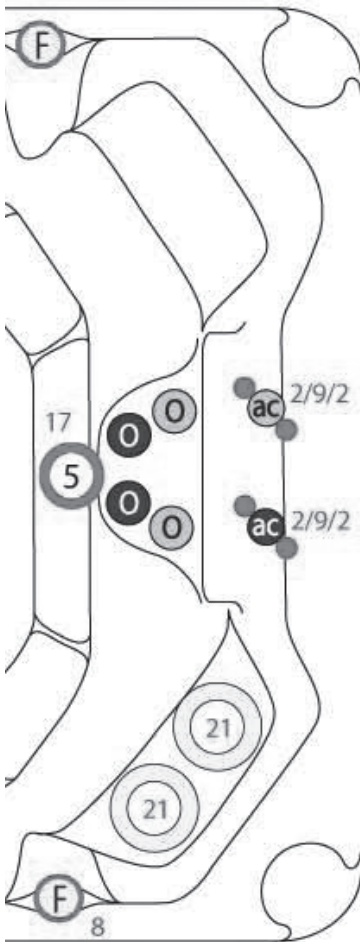

(F) 8	(Water Feature Icon)	Water Feature
□ 7	(Drain Icon)	Drain
● 9	(2" LED Light Icon)	2" LED Light
(5) 17	(5" LED Light Icon)	5" LED Light
□ 15	(Suction Icon)	Suction
(MP) 8	(Cluster Storm Pulsator Icon)	Cluster Storm Pulsator
(MSP) 11	(Mini Storm Spinner Icon)	Mini Storm Spinner
(MS) 11	(Mini Storm Directional Icon)	Mini Storm Directional
(PSAJ) 13	(Poly Storm Massage Icon)	Poly Storm Massage
(PSPL) 13	(Poly Storm Spinner Icon)	Poly Storm Spinner
(o/o) 10	(3/4" On / Off Valve Icon)	3/4" On / Off Valve
(AV)	(Air Valve Icon)	Air Valve
(O)	(Swim Jet Icon)	Swim Jet
(ac) 9	(Air control Icon)	Air control

**⚠ NOTE!**

**DRAWING MAY VARY - MANUFACTURER HAS RESERVED RIGHTS FOR ANY CHANGES OR MODIFICATIONS.**



# 16' SWIM SPA SCHEMATIC

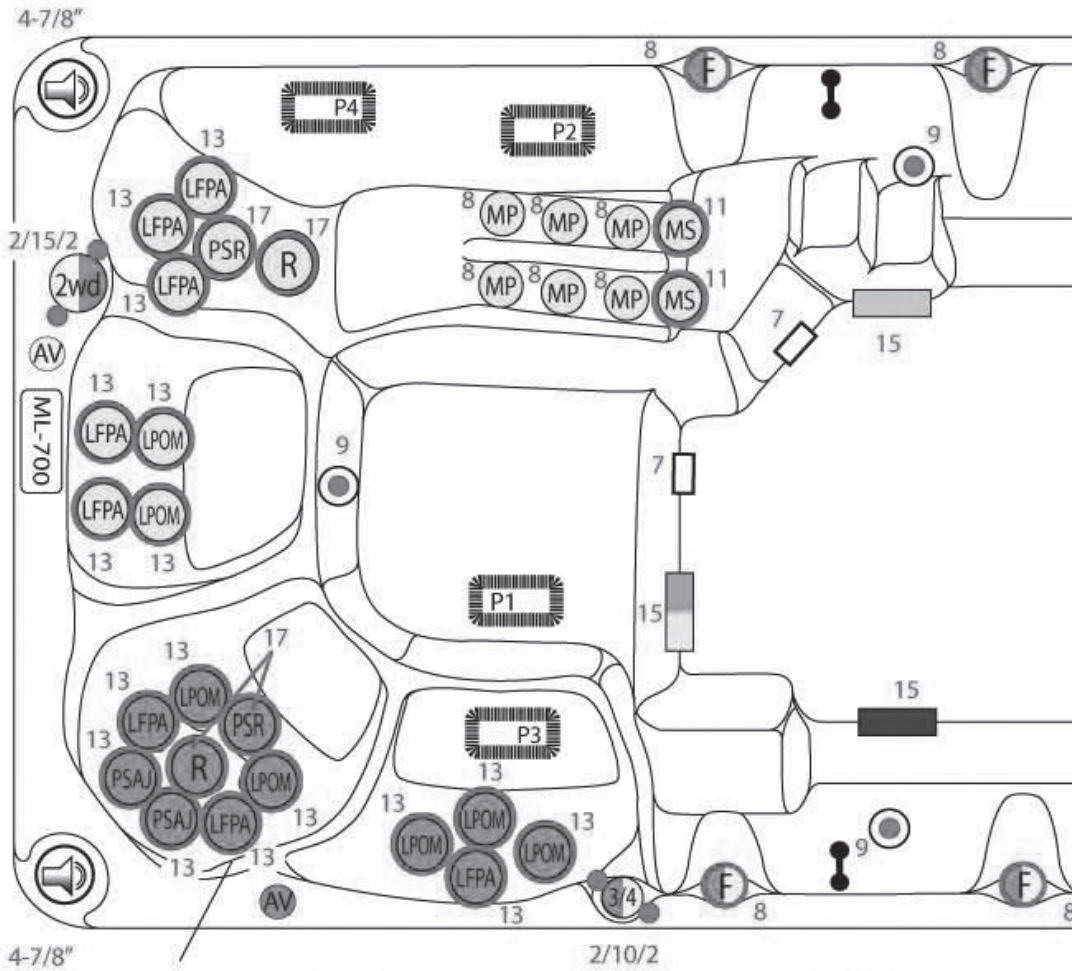

# 16' SWIM SPA SCHEMATIC

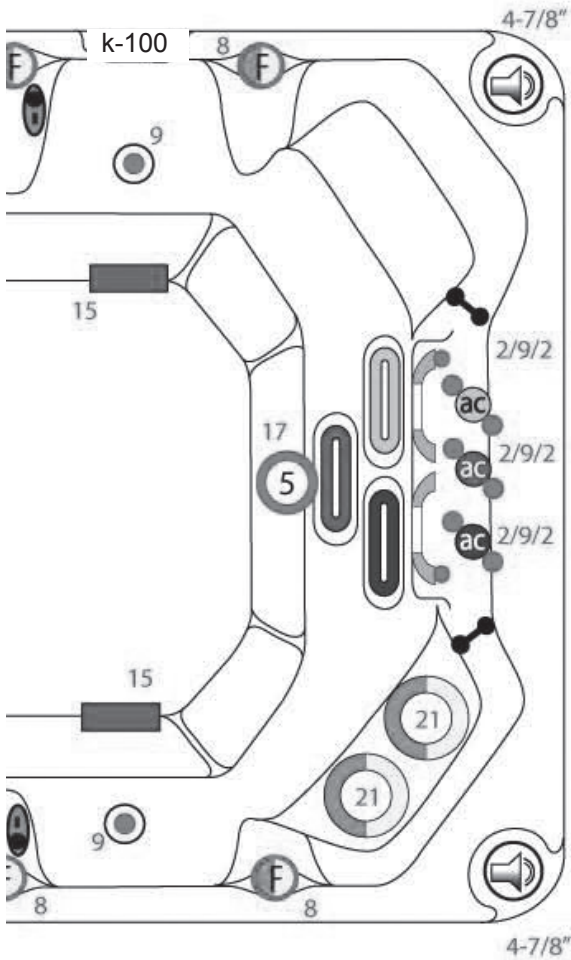

(MSP) 11		Mini Storm Spinner
(MS) 11		Mini Storm Directional
(MM) 20		Master Massage
(LPOM) 13		LG Face Poly Storm Massage
(PSPL) 13		Poly Storm roto
(LFPA) 13		LG Face Poly Storm Directional
(PSAJ) 13		Poly Storm Directional
4 4		7" Cascade Waterfall
(POLM) 13		Poly Storm Directional
(PSR) 17		Power Storm Resonator
(PWRM) 17		Power Storm Massage
(R) 17		Power Storm Spinner
(MP) 8		Cluster Storm Pulsator
(AE) 4		Adjustable Euro
● 1		LED Lighting
(E) 4		Euro
(ST) 4		Surface Tension (Euro)
(AE) 8		Adjustable Cluster
(F) 8		Water Feature
(MP) 11		Mini Pulsator
□ 7		Drain
● 9		2" LED Light
● 5		5" LED Light

## ⚠ NOTE!

DRAWING MAY VARY - MANUFACTURER HAS RESERVED RIGHTS FOR ANY CHANGES OR MODIFICATIONS.

# 18' SWIM SPA SCHEMATIC

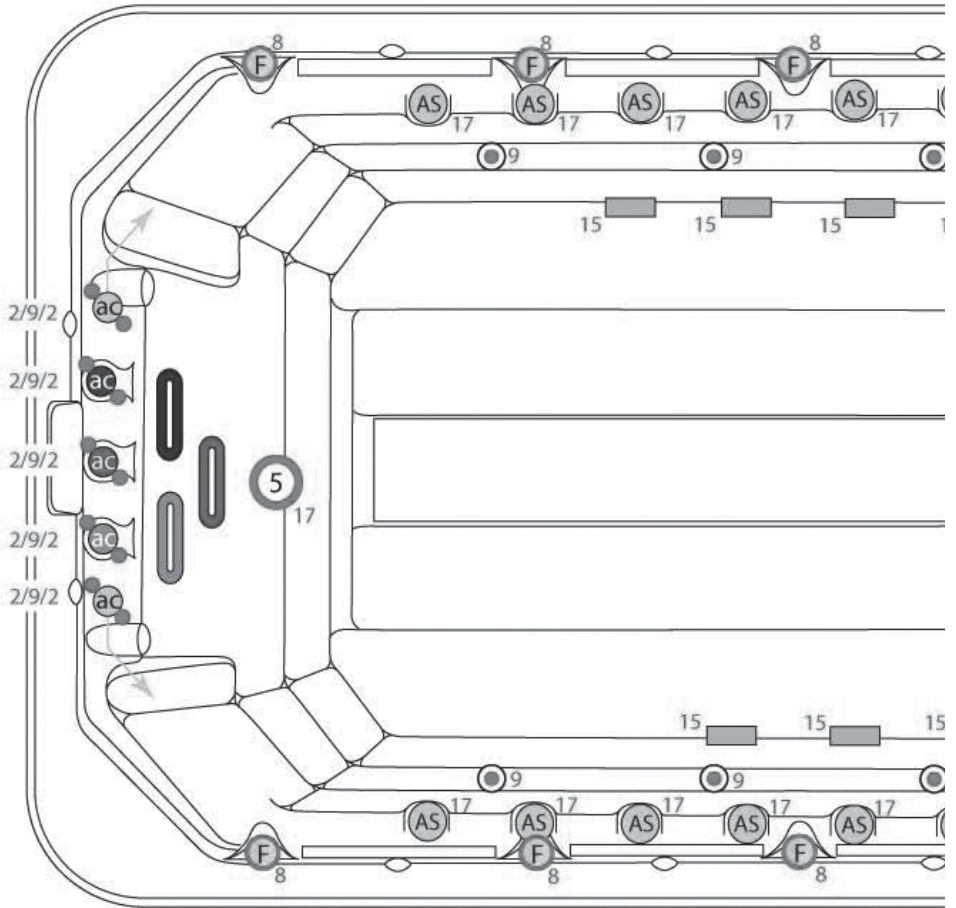

# 18' SWIM SPA SCHEMATIC

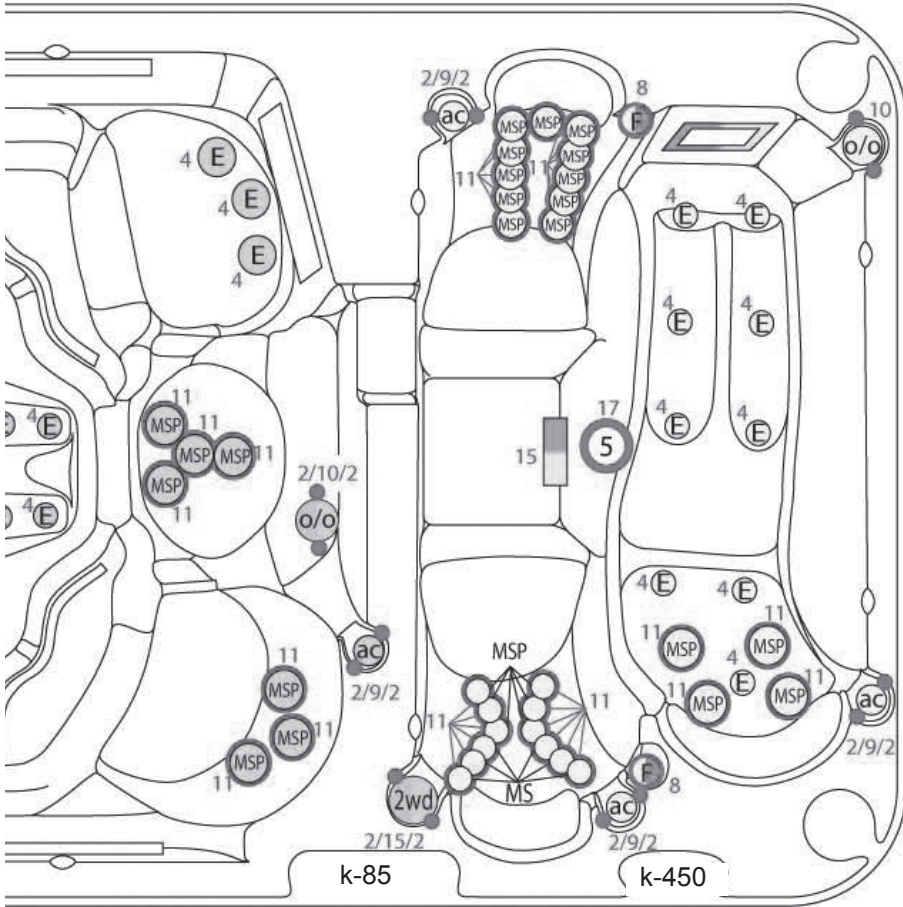

ac	Air Control	○ ●	LED Lighting
o/o	1" On / Off Valve	□	Drain
AS	Power Storm Directional	□	Suction
E	Euro Jet	2wd	2" Water Diverter
		MS	Mini Storm Directional



## ⚠ NOTE!

DRAWING MAY VARY - MANUFACTURER HAS RESERVED RIGHTS FOR ANY CHANGES OR MODIFICATIONS.

---

## DRAINING YOUR SPA

---

Because your spa holds a relatively small amount of water, contaminants such as body oil, perspiration, dirt, hair, etc., may become quite concentrated. For this reason, the water should be drained and replaced every three months depending on use.

- Turn off power at the breaker.
- Hook up a garden hose to the hose bib located on the exterior drain of the cabinet to access the hose bib, please pull the cap out and turn counter clock wise to remove the cap, attach hose to the drain.
- When water begins to drain out of the hose, be sure to drain the water to a convenient place.

After draining is completed, turn the hose bib off by pushing in and turn clockwise one half turn. Remove the hose. Wipe down the inside of your spa making sure your surface is dry and free from standing water. We recommend that after draining or cleaning your spa that you put the cover back on. Avoid exposing the acrylic surface to direct sunlight for an extended period of time. Extended exposure can cause surface fading or cracking, which could void the acrylic warranty.

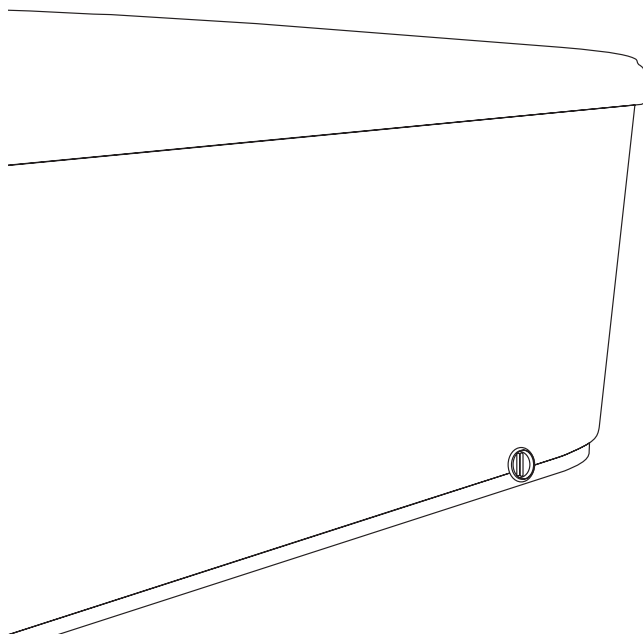

### NOTE!

**Note:** Be sure that hose is on a downward grade to properly drain spa.

---

## WINTERIZING YOUR SPA

---

### WARNING!

**In areas of the country where the temperatures drop below 32° F (0° C), it is important to follow these directions:**

When winterizing the spa, we recommend putting RV Antifreeze in the spa and running it before draining the spa.

- 1) If the spa is not going to be used, drain completely. Be sure all water is removed. Break or loosen unions at each end of pump to ensure water from pump area is removed. Remove pump freeze plugs if so equipped. Using a shop vacuum, vacuum all jets thoroughly to remove any water left over in the plumbing lines.
- 2) Do not turn unit off with water in the spa. Frozen water may rupture plumbing. Freeze damage repairs are not covered under warranty.
- 3) Remove and clean filter cartridge. Store cartridge in a secure place to prevent freezing. If the spa is going to be used, maintain normal operating procedures and ensure cover is in place when possible.

### NOTE!

**Note: Freeze ups or damage caused by freezing are not covered under warranty!**

---

## SPRINGTIME START-UP

---

If your swim spa has been winterized. The Manufacture highly recommend that you contact an authorized dealer to restart your swim spa. This following is an outline of the procedures involved.

- Make sure all o-rings for pumps are in place and undamaged.
- Make sure all the fittings that loosened are re-tighten.
- Replace all jet fittings, pump drain plugs, hose bib drains, and bleeder valves.
- Fill the swim spa, with water in a normal way,
- Run the jets on high for about 15 minutes.
- Drain the water.
- Put the filters back in.
- Refill the system and treat chemically as one would after a normal water change.

For more information about Winterizing your system, or restarting a winterized system, please contact your local Authorized dealer.

---

## MAINTAINING YOUR SPA COVER

---

### Proper Maintenance For Your Spa Cover

- 1) Use a soft broom to remove accumulation after every snowfall or ice storm.
- 2) Splash cool tap water on the hardware to free them if they become frozen shut. Household lubricating oil will keep the lock free, but apply carefully because it can damage the cabinet finish.
- 3) We recommend a good treatment with Vinyl Conditioner before the first snow or ice. If possible, treat during the winter too.
- 4) Monitor your water chemistry. Even if the spa is not used regularly, improper water chemistry can cause a mildew build-up on the cover. Clean, PH controlled water will prolong the life of the cover.
- 5) If mildew is found, remove foam cores from the vinyl encasement. Mix water, a teaspoon of mild dish washing soap and a cup of bleach. With a soft bristle brush, scrub the inside and outside of the vinyl encasement thoroughly. Then take a washcloth and wipe down each foam core, rinse thoroughly. Place the encasement in the sun and foam cores in the shade to dry. Once everything is thoroughly dry, spray the cores and encasement with a mildew inhibitor. Allow to dry completely, then reassemble. The key here, of course, is to maintain proper water chemistry to avoid mildew.
- 6) We suggest rotating the cover every six months to maintain even wear. Unzip the cover, remove the foam cores, turn over and reassemble.

**Ask Your Dealer About Using A Cover Caddy**

**PROTECT YOUR COVER!**



---

## TROUBLE SHOOTING GUIDE

---

### **No heat or heat too low**

- Probable Cause #1 ..... Dirty Filter.  
Action ..... Remove filter cartridge and clean.
- Probable Cause #2 ..... Breaker at house off.  
Action ..... Reset breaker at house. Breaker can appear to be on and one pole can be off. Turn breaker OFF then ON twice.
- Probable Cause #3 ..... Pump not primed.  
Action ..... Refer to the section of this manual on pump priming.
- Probable Cause #4 ..... Improper line voltage.  
Action ..... Have a Licensed Electrician check the line voltage.

### **Pump will not prime**

- Probable Cause #1 ..... No water in pump.  
Action ..... Make sure water level in spa is correct.
- Probable Cause #2 ..... Closed gate valves or blocked lines.  
Action ..... Open all gate valves. Check suction for blockage.
- Probable Cause #3 ..... Pump surges, jets lose and gain power, loose union or drain plug.  
Action ..... Check union on front or nose of pump to ensure tightness. Check drain plugs to ensure tightness.

### **Jet(s) won't come on**

- Probable Cause #1 ..... Pump not primed.  
Action ..... Refer to the section of this manual on pump priming.
- Probable Cause #2 ..... Gates valves closed.  
Action ..... Check to see if gate valves are in the correct position. Check to see that pump is plugged in.
- Probable Cause #3 ..... Water Diverter Valve not adjusted correctly.  
Action ..... Turn Water Diverter Valve until desired water flow is obtained.
- Probably Cause #4 ..... Individual jet is closed.  
Action ..... Turn the outer jet housing clockwise to turn jet on.

### **Low water flow**

- Probable Cause #1 ..... Dirty Filter.  
Action ..... Remove filter cartridge and clean.
- Probable Cause #2 ..... Closed gate valves or blocked lines.  
Action ..... Open all gate valves.
- Probable Cause #3 ..... Low voltage or incorrect voltage.  
Action ..... Have a Licensed Electrician check the line voltage.



---

## TROUBLE SHOOTING GUIDE (CONT.)

---

### Spa is leaking

Probable Cause #1..... Loose connection.

Action ..... Hand tighten all disconnects and fittings. Check joints and unions.

### Motor does not run

Probable Cause #1..... No power to motor.

Action ..... Check power switches and circuit breakers. Check motor plug where plugged into control box.

Probable Cause #2..... Pump jammed from foreign matter in impeller.

Action ..... Call dealer for recommended action.

Probable Cause #3..... Motor overheats on hot days while filtering.

Action ..... Reprogram your controls to cycle during the coolest parts of the day and on shorter cycles. (see programming instructions).

### Motor runs hot

Probable Cause #1..... Pump ran dry.

Action ..... Call dealer for recommended action.

Probable Cause #2..... Restricted suction lines.

Action ..... Make sure all valves are open/clear suction of debris.

Probable Cause #3..... Improper ventilation

Action ..... Insure that vents on side of spa are free and clear of any debris or landscaping. Spa should also be located an adequate distance from any walls or fencing for good ventilation.



### NOTE!

**Note: These motors will feel hot to the touch. This is normal. The Overheat Sensor will turn the motor off if there is an overload or high temperature problem.**

---

## **GLOSSARY OF TERMS**

---

- Air Control or Venturi** ..... Mounted on the lip of the spa or at the equipment shroud, to induce air to the jets.
- Cabinet** ..... The natural or synthetic wood panels that surround the spa, also called a skirt.
- Control Panel**..... Mounted on the lip of the spa, the digital panel that controls the spa's functions.
- Control Box**..... Basically the brain of the spa. Distributes power to all functions of the spa, pumps, ozonator, heater, LED, etc.
- Drain** ..... The fitting set into the footwell that drains water from the spa.
- Filter**..... The filter cleans the spa, removes particles and debris, and protects the equipment from foreign substances.
- Footwell** ..... The bottom of a spa where you place your feet. SPA SPAS is known for it's larger foot wells and comfortable seating.
- G.F.C.I. Breaker**..... The electronic switch installed in the power box of your house to give power to the spa. This is a non-user serviceable part.
- Gate Valves** ..... T-handled valves located at the inlets and outlets of the equipment. The gate valve blocks or opens the water line by the equipment.
- Heater**..... The thermostatically controlled heater raises the temperature of the water to the desired degree. This is located under the control box in the equipment area.
- Hose Bib** ..... Used in the draining of the spa, fits a standard garden hose.
- Jets** ..... The fittings on your spa that direct the flow of water for massaging action.
- Ozone** ..... A water purification supplement method using Ozone gas. Ozone gas, made by an Ozone Generator unit, can reduce your sanitizer needs by up to 25%.
- pH** ..... Stands for "Potential for Hydrogen" This is the term used to describe the acid (low pH) or alkaline (high pH) condition of the water. The ideal pH for spa water is 7.5.

---

## NOTES

---

---

# NOTES

---

## **Limited Warranty Summary**

Please refer to the Warranty Card included with your product for complete warranty information. In order to receive prompt warranty service, you must register your spa - ask your dealer about registering. The manufacturer provides a limited warranty to our customers. It applies to the spa structure, surface, plumbing, pumps, heater, blower, and controls. The limited warranty does not cover damage resulting from improper maintenance, improper installation, misuse, abuse, accident, fire, normal wear and tear, or improper water maintenance. Unauthorized modifications of the spa may void the warranty. Replacement costs associated with transportation, removal, and reinstallation are the sole responsibility of the spa owner.

This manual refers to the swim spa. The manufacturer reserves the right to make changes in design or material of its products at any time without incurring liability. This limited warranty applies to the first retail purchaser and terminates upon any transfer of ownership.

## **Disclaimer:**

The information in this manual is accurate to the best of the manufacturer's knowledge. However, the manufacturer assumes no responsibility for errors or omissions. Nor is any liability assumed for damages resulting from use of the information contained herein.

## **Safety Sign**

The safety sign enclosed with your Owner's Manual packet should be permanently installed where visible to all users of the spa. It is very important that you, as a spa owner, review the important safety instructions and warnings before you operate your spa. It is equally important that you instruct all users, even occasional ones, as to the warnings associated with spa use. You may obtain additional signs by contacting:

Spa Manufacturer  
1815 Milton Rd  
Athens, TN 37303  
800-951-6224

001217.021910

**Spa Manufacturer**  
**1815 Milton St.**  
**Athens, TN 37303**  
**800-951-6224**



©2010 The manufacture reserves the right to make product modifications and enhancements.