



2005
owner's manual

powered by JetPaks

bullfrog[™]
spas

tadpole[™]
hot tubs

Important Overview

Congratulations on your purchase of a Bullfrog Spa or Tadpole Hot Tub by Bullfrog. Bullfrog's spas are the world's only spas equipped with the patented JetPak System™. JetPak™ technology delivers incredible power, maximum versatility and allows you to upgrade your spa's jetting with new JetPaks™, both now and in the future. **NOTE:** In this document, the terms "Spa" and "Hot Tub" are used interchangeably.

Take a moment to read this manual carefully as you prepare for the delivery and installation of your new spa. Following the instructions in this manual will ensure the safe, secure, and timely installation and operation of your new spa.

Carefully read this Owner's Manual **before** you install your spa. Your Bullfrog Spa or Tadpole Hot Tub limited warranty will be void if damage is caused by failure to install, maintain, and operate your spa in accordance with the recommendations contained in this Owner's Manual or any other printed instruction, notice or bulletin from Bullfrog International, LC. It is also important that you complete and mail the enclosed Warranty and Registration Card, or you may register your spa online at www.bullfrogspas.com. Please register your new spa within thirty days of delivery.

Your spa's serial number is located on the Manufacturing ID Label located inside the equipment compartment of your spa.

For the safety of all those who utilize your spa and its surroundings, please make sure your spa and any adjoining installations, including the electrical hook-up, are completed only after acquiring any necessary approvals and permits from your local city and/or county. Some jurisdictions require certain fencing and/or self-closing and self-latching gates to prevent accidental drowning in a pool or spa. Your spa cover (optional) comes with a locking system that meets the ASTM F1346-91 Standard for Safety Covers, which when properly used, may satisfy certain fencing and gating requirements.



U.S. Patents: 5,754,989, 5,987,663, 6000,073, 6,092,246, 6,256,805, 6,543,067 with additional U.S. patent pending.

Foreign Patents: New Zealand Patent 334093. Other patents pending in 13 additional countries.



Bullfrog International, LC reserves the right to change features, specifications and design without notification and without incurring any obligation.

Table of Contents

Important Safety Instructions

| | |
|-------------------------------------|---|
| Safety Instructions..... | 1 |
| Additional Safety Instructions..... | 2 |
| Warning Signs..... | 3 |

| | |
|------------------------------------|---|
| Quick Reference Chart | 4 |
|------------------------------------|---|

| | |
|---|---|
| Spa JetPaks™ and Accessories | 5 |
|---|---|

Installation and Setup

| | |
|--|----|
| Site Selection and Preparation..... | 6 |
| Delivery Basics..... | 10 |
| Electrical Requirements and Installation Instructions..... | 13 |
| Pre-Fill Checklist..... | 22 |

Operation

| | |
|---------------------|----|
| Control System..... | 24 |
| JetPaks..... | 30 |
| Jetting..... | 32 |
| JetZones™..... | 33 |

Maintenance

| | |
|-------------------------------------|----|
| Water Chemistry..... | 34 |
| Changing Spa Water..... | 37 |
| Filter Cleaning..... | 38 |
| Light Bulb and LED Replacement..... | 39 |
| Ozone Purifier Replacement..... | 39 |
| Spa Shell Care..... | 40 |
| JetPak™ Plumbing Care..... | 40 |
| Spa Cabinet Care..... | 40 |
| Spa Cover Care..... | 40 |
| Miscellaneous Care..... | 40 |
| Freeze Prevention..... | 41 |

| | |
|--|----|
| Low-Use or No-Use Periods | 41 |
|--|----|

| | |
|----------------------|----|
| Service | 42 |
|----------------------|----|

| | |
|------------------------------------|----|
| Troubleshooting Guide | 43 |
|------------------------------------|----|

Miscellaneous

| | |
|------------------------------------|----|
| Spa Technical Specifications..... | 44 |
| Parts Identification Diagrams..... | 46 |



IMPORTANT SAFETY INSTRUCTIONS

SAVE THESE INSTRUCTIONS

When installing and using this electrical equipment, basic safety precautions should always be followed, including the following:

1. READ AND FOLLOW ALL INSTRUCTIONS:

2. **▲WARNING:** To reduce the risk of injury, do not permit children to use this product unless closely supervised at all times.
3. As per UL requirements (U.S.), a wire connector is provided on this unit to connect a minimum No. 8 AWG (8.4mm²) solid copper conductor between this unit and any metal equipment, metal enclosures of electrical equipment, metal water pipe, or conduit within 5 feet (1.5m) of the unit.
4. **▲WARNING:** For products provided with a cord-connected, ground-fault circuit-interrupter, the GFCI must be tested before each use. If the GFCI fails to operate properly, disconnect the power until the fault has been identified and corrected.
5. **▲DANGER:** Risk of Accidental Drowning. Extreme caution must be exercised to prevent unauthorized access by children. To avoid accidents, ensure that children cannot use this spa unless they are supervised at all times.
6. **▲DANGER:** Risk of Injury. The suction fittings in the spa are sized to match the specific water flow created by the pump. Should the need arise to replace the suction fittings or the pump, be sure that the flow rates are compatible. Never operate the spa if the suction fittings are broken or missing. Do not replace a suction fitting with one rated less than the flow rate marked on the original suction fitting.
7. **▲DANGER:** Risk of Electric Shock. As per UL requirements (U.S.), install spa at least 5 feet (1.5m) from all metal surfaces. A spa may be installed within 5 feet (1.5m) of metal surfaces if each metal surface is permanently connected by a minimum of No. 8 AWG (8.4mm²) solid copper conductor to the wire connector on the terminal box that is provided for this purpose.
8. **▲DANGER:** Risk of Electric Shock. Do not permit any electrical appliances, such as a light, telephone, radio, or television within 5 feet (1.5m) of the spa. These units DO NOT have an integral ground fault circuit interrupter. The

installation of an integral ground fault circuit interrupter MUST be completed by a qualified Electrician and must meet all applicable electrical codes.

9. **▲WARNING:** To Reduce the Risk of Injury:
 - a. Water temperature in a spa should never exceed 104°F (40°C). Water temperatures between 100°F (38°C) and 104°F (40°C) are considered safe for a healthy adult. Water temperature in excess of 104°F (40°C) may be injurious to your health. Lower temperatures are recommended for young children and/or when spa use exceeds 10 minutes.
 - b. Since excessive water temperatures have a high potential for causing fetal damage during the early months of pregnancy, pregnant, or possibly pregnant, women should limit spa usage when temperatures are in excess of 100°F (38°C).
 - c. Before entering the spa, measure the water temperature with an accurate thermometer since the tolerance of water temperature regulating devices varies.
 - d. The use of alcohol, drugs, or medication before or during spa use may lead to unconsciousness with the possibility of drowning.
 - e. Persons suffering from obesity or a medical history of heart disease, low or high blood pressure, circulatory system problems, and/or diabetes should consult a physician before using a spa.
 - f. Persons using medication should consult a physician before using a spa. Some medications may induce drowsiness while other medication may affect heart rate, blood pressure, and/or circulation.
10. For Cord-Connected units: a) Replace damaged cord immediately. b) Do not bury cord. c) Connect to grounded, grounding-type receptacle only.
11. **▲WARNING:** PEOPLE WITH INFECTIOUS DISEASES SHOULD NOT USE A SPA OR HOT TUB.
12. **▲WARNING:** TO AVOID INJURY, EXERCISE CARE WHEN ENTERING OR EXITING THE SPA OR HOT TUB.
13. **▲WARNING:** DO NOT USE A SPA OR HOT TUB IMMEDIATELY FOLLOWING STRENUOUS EXERCISE.

14. **▲WARNING:** PROLONGED IMMERSION IN A SPA OR HOT TUB MAY BE INJURIOUS TO YOUR HEALTH.
15. **▲CAUTION:** MAINTAIN WATER CHEMISTRY IN ACCORDANCE WITH MANUFACTURER'S INSTRUCTION.
16. **▲CAUTION:** TEST THE GROUND FAULT CIRCUIT INTERRUPTER BEFORE EACH USE OF THE SPA.
17. **▲CAUTION:** ADEQUATE DRAINAGE MUST BE PROVIDED IF THE EQUIPMENT IS TO BE INSTALLED IN A PIT.
18. **▲WARNING:** Risk of Fatal Hyperthermia. Hyperthermia occurs when the internal temperature of the body reaches a level several degrees above the normal body temperature of 98.6° F (37° C). The symptoms of Hyperthermia include dizziness, lethargy, drowsiness, and fainting. The use of alcohol, drugs, and/or medication can greatly increase the risk of fatal Hyperthermia. The effects of Hyperthermia include:
 - Unawareness of impending hazard
 - Failure to perceive heat
 - Failure to recognize the need to exit the spa
 - Physical inability to exit the spa
 - Fetal damage in pregnant women
 - Unconsciousness and danger of drowning

Additional Instructions (Canadian Installations Only):

19. A green-colored terminal or a terminal marked G, GR, Ground, Grounding or the international grounding symbol is located inside the supply terminal box or compartment. To reduce the risk of electric shock, this terminal must be connected to the grounding means provided in the electric supply service panel with a continuous copper wire equivalent in size to the circuit conductors supplying this equipment.
20. At least two lugs marked "BONDING LUGS" are provided on the external surface or on the inside of the supply terminal box or compartment. To reduce the risk of electric shock, connect the local common bonding grid in the area of the spa or hot tub to these terminals with an insulated or bare copper conductor not smaller than No. 6 AWG.
21. All field-installed metal components such as rails, ladders, drains, or other similar hardware located within 10 feet (3m) of the spa or hot tub shall be bonded to the equipment grounding bus with copper conductors not smaller than No. 6 AWG.

SAVE THESE INSTRUCTIONS

Additional Safety Instructions

1. **▲WARNING:** Risk to Infants, Elderly, and Women Planning or Experiencing Pregnancy. Please consult your physician if the above applies to you or anyone using the spa.
2. **▲WARNING:** Risk of Children Drowning. Your spa cover is not rated as a safety cover. It is always wise to keep the spa cover securely fastened when not in use. This will help discourage children from attempting to enter the spa unsupervised.
3. **▲WARNING:** Risk of Drowning. Use caution when bathing alone. Overexposure may cause nausea, dizziness, and fainting.
4. **▲CAUTION:** Risk of Injury. Young children should be supervised so that they do not play with the appliance.
5. **▲WARNING:** Risk of Injury: To avoid injury, exercise care when entering or exiting the spa. Surfaces can be slippery when wet. Do not step or sit on headrests or FilterCap™. Also, keep all breakable objects away from the spa area.
6. **▲WARNING:** Risk of Injury: Short-term inhalation of high concentrations of ozone and long-term inhalation of low concentrations of ozone can cause serious physiological effects.
7. **▲CAUTION:** Unauthorized Access. Secure the spa area against unauthorized access. Make sure all spa barriers (fences, enclosures, etc.) meet all applicable national and local codes. Keep spa cover on and locked when it is not being used.
8. **▲CAUTION:** Risk of Damage to Spa or Equipment. By performing maintenance as described in this manual, the chance of damage to your spa and its equipment will be reduced. Never block the air vents that lead to the spa's equipment compartment, doing so may cause the spa to overheat.
9. **▲WARNING:** Risk of Electric Shock or Death. Do not operate spa during severe weather conditions (e.g. electrical storms, tornadoes, etc.).
10. **▲CAUTION:** Non-Approved Accessories. Using accessories not approved by Bullfrog International, LC could void your warranty or cause other problems. Please consult your authorized Bullfrog Spa dealer.

11. **⚠️ CAUTION:** Location of Your Spa. Locate your spa on a foundation that can support the maximum filled weight of your spa along with the weight of all the occupants using the spa (see *Site Selection and Preparation*). Also, locate your spa in an environment that can withstand repeated exposure to water and the possibility of a major spill.
12. **⚠️ CAUTION:** Cordage shall be replaced only with a special cordage assembly available from the Manufacturer, its Service Agent, or similarly qualified persons in order to avoid a hazard.
13. **⚠️ WARNING:** This appliance is not intended for use by young children or infirm persons without supervision.
14. **⚠️ WARNING:** Before obtaining access to supply terminals, all supply circuits must be disconnected.
15. **⚠️ WARNING:** Risk of Injury or Accidental Drowning: Do not use spa without filters and FilterCaps™ installed. The filters and FilterCap serve as a barrier against bodily entrapment against the filter suction fitting(s).

SAVE THESE INSTRUCTIONS



Warning Signs

| WARNING | |
|--|---|
| <p>PREVENT DROWNING</p> <ol style="list-style-type: none"> 1. SUPERVISE CHILDREN AT ALL TIMES. 2. ATTACH SPA COVER AFTER EACH USE. 3. SPA HEAT CAN CAUSE HYPERTHERMIA AND UNCONSCIOUSNESS. 4. SPA HEAT IN CONJUNCTION WITH ALCOHOL, DRUGS, OR MEDICATION CAN CAUSE UNCONSCIOUSNESS. | <p>PREVENT ELECTROCUTION</p> <ol style="list-style-type: none"> 1. NEVER PLACE ANY ELECTRIC APPLIANCE WITHIN 5 FEET OF SPA. <p>PREVENT INJURY</p> <ol style="list-style-type: none"> 1. ALWAYS CHECK WATER TEMPERATURE BEFORE ENTERING SPA. WATER TEMPERATURE SHOULD NOT EXCEED 104°F (40°C). |
| <p>NOTE: THIS MARKING IS TO BE REMOVED ONLY BY THE OWNER.</p> | |

| WARN | |
|---|--|
| <p>PREVENT DROWNING</p> <p>SUPERVISE CHILDREN AT ALL TIMES. ATTACH SPA COVER AFTER EACH USE. SPA HEAT CAN CAUSE HYPERTHERMIA AND</p> | <p>PREVENT INJURY</p> <ol style="list-style-type: none"> 1. NEVER PLACE ANY ELECTRIC APPLIANCE WITHIN 5 FEET OF SPA. |

| WARNING | |
|--|--|
| <p>DURING PREGNANCY, SOAKING IN HOT WATER MAY CAUSE DAMAGE TO THE FETUS. LIMIT USE TO 10 MINUTES AT A TIME.</p> | |
| <p>PREVENT DROWNING</p> <ol style="list-style-type: none"> 1. SPA HEAT SPEEDS UP THE EFFECTS OF ALCOHOL, DRUGS, OR MEDICINE AND CAN CAUSE UNCONSCIOUSNESS. 2. IMMEDIATELY LEAVE SPA IF UNCOMFORTABLE OR SLEEPY. | <p>PREVENT CHILD DROWNING</p> <ol style="list-style-type: none"> 1. WATER ATTRACTS CHILDREN. ALWAYS ATTACH A SPA COVER AFTER EACH USE. <p>PREVENT INJURY</p> <ol style="list-style-type: none"> 1. ALWAYS CHECK WATER TEMPERATURE BEFORE ENTERING SPA. WATER TEMPERATURE SHOULD NOT EXCEED 104°F (40°C). |

Included with the spa are three warning signs to inform users and guests of the risk involved with using a spa. All of these warning signs are suitable for indoor and outdoor use. Place these warning signs in a noticeable place adjacent to the spa. For free additional copies, contact Bullfrog International, LC at (801) 565-8111 or info@bullfrogspas.com.

Quick Reference Chart

To assist you with the installation, maintenance, and service of your new spa, please fill out the following information and keep it on hand for future reference.

Spa Information

Spa Model: _____

Serial Number: _____

Dealership: _____

Dealer's Phone Number: _____

Date Purchased: _____

Date Installed: _____

Contractor Information

General

1. Name: _____

Telephone: _____

2. Name: _____

Telephone: _____

Electrician

1. Name: _____

Telephone: _____

2. Name: _____

Telephone: _____

Concrete, Decking, and Masonry

1. Name: _____

Telephone: _____

2. Name: _____

Telephone: _____

Landscaping

1. Name: _____

Telephone: _____

2. Name: _____

Telephone: _____

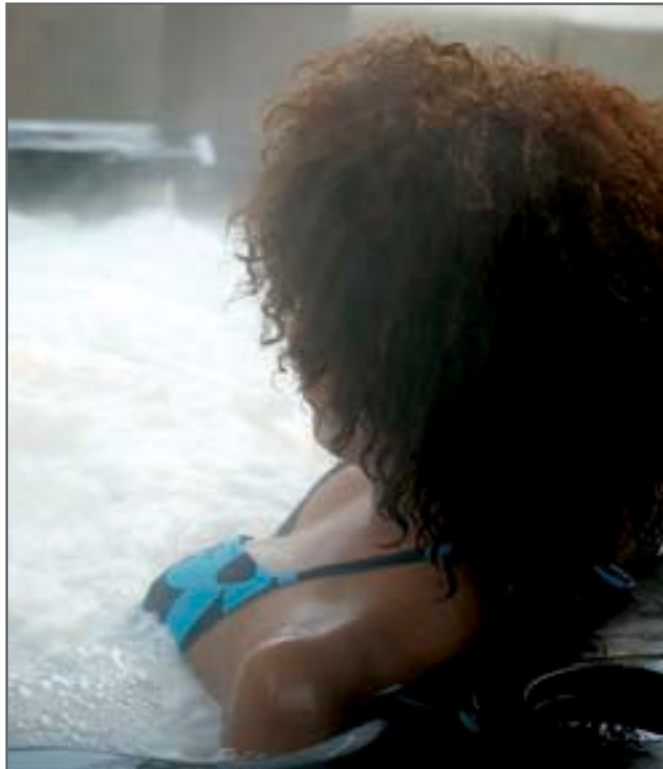

Spa JetPaks™ and Accessories

JetPaks: In addition to the JetPaks that come with your spa, you may want to consider increasing your JetPak™ selection. Additional JetPaks will not only provide you with exciting hydrotherapy options, but will also keep your spa feeling new. JetPak models currently available are as follows:



Oscillator™
J01-46-4



BodyWand™
J09-12-1



Pulsator™
J02-70-6



Spinal'ssage™
J10-22-3



ClusterBurst™
J03-63-12



Gyro'ssage™
J11-58-5



NeckBlaster™
J04-100-14



Mini ClusterBurst™
J12-42-8



Alee "V" 8™
J05-58-8



RainShower™
J13-30-42



Mini NeckBlaster™
J06-56-7



StormShower™
J14-63-79



Shiatsu
J07-36-1



HurricaneShower™
J15-100-128



Aroma'ssage™
J08-35-3



Cascadia™
J16-55-4



Spa & Yard™ Stereo: Marine-grade stereo and CD player with spa-side controls and Bose® speakers. Listen to your favorite CDs or radio station in your spa or in the yard. **NOTE:** This option is not available on the Bullfrog 331, Tadpole 251, or Tadpole 362.

CoverMate-I Cover Lifter: Makes uncovering and covering your spa simple and easy. While you are using your spa, your cover is neatly stored behind the spa, providing a useful privacy screen.

WellSpring™ Ozone Purifier: Nature's way for the cleanest spa water. Supplement the chemical treatment of your spa and improve the spa's water quality by adding a Standard or High-Output Ozone Purifier. **▲IMPORTANT:** Your spa was designed, tested, and safety listed with either a Bullfrog CDS-16 (standard) or MCD-50 (high-output) ozone purifier. No other ozone purifier is recommended for your Bullfrog Spa. **▲WARNING:** The use of any other Ozone Purifier will void the safety listing on your spa. **NOTE:** The High-Output Ozone option is not available on the Tadpole 251 or Tadpole 362. **▲WARNING:** Use of any High-Output Ozone system in a Tadpole Hot Tub can cause serious damage to the appliance and/or possible health risks from inhalation of ozone gas.

LED Lighting System: A must for nighttime fun and for creating just the right mood. In addition to considerably outlasting and outshining 12V spa lights, our LED Lighting System provides eight unique color schemes as well as an automatic color changing program.

PowerDrain™: Reduces the time it takes to drain your spa from hours to just a few minutes. Comes complete with a 25' (7.62m) drain hose.

SpinClean™ Filter Cartridge Cleaning System: Cleans your spa filter cartridges without all the hassle and without you getting splashed.

DuraSteps™: Steps that are not only lightweight and very tough, but they make getting in and out of your spa a snap. Available in Brown, Gray, and Sand.

SpaMonitor™: Gain peace of mind as you continually monitor the health of your backyard spa from the convenience of any room in the house. Adjust the temperature, lights, and pumps of your spa without leaving the comfort of your home. A built-in alarm alerts you of problems or power outages. (Available in U.S./CAN only.)

Additional upgrades and products are continuously available. Please contact or visit your authorized Bullfrog Spa dealer for details.



Installation and Setup

Before attempting to install or use your spa, please read *Important Safety Instructions* as well as all the installation instructions that follow.

Site Selection and Preparation

Your home most likely offers multiple sites where your spa may be installed. Use the information presented in this section to assist you in carefully selecting the site that works best for you. It is your responsibility to choose and prepare the site properly **before** delivery, so you will experience a smooth and efficient delivery as well as obtain optimal use and full enjoyment of your spa.

Environment

Surroundings: The direction that your spa will be facing will contribute to your overall bathing experience. Select the spa location that will provide optimal views based on your property layout. Consider your lifestyle and where you want to enjoy your spa and situate it accordingly. Indoor installations provide privacy, but create high levels of humidity (see *Indoor Considerations*). If your spa is outside, a nearby place for you and your guests to change clothes is a huge convenience. Also, a location near a house entry is convenient in areas with extreme winter climates.

Indoor Considerations: Indoor spa installations have special requirements. Your Bullfrog Spa or Tadpole Hot Tub is the most leak-free spa in the industry, but there is still a chance of a leak from the spa. The environment both around and below the spa should be water resistant, and preferably waterproof. It must be capable of handling water splashed out from the spa as well as the possibility of a leak. Recommendations to handle water around the spa include, but are not limited to, a floor drain and/or a catch basin equivalent to the volume of water in your spa. Condensation can also occur on the spa cover and drip onto the floor. Therefore, ensure that flooring materials provide a good grip when wet and are resilient to constant exposure of water and chemicals. In addition to handling the water from the spa, it is recommended that the room be properly ventilated. Humidity levels will naturally increase after the spa is installed and in use. Water may get into woodwork and produce dry rot, mildew, or other problems. Over time, high levels of humidity and spa chemicals can cause water damage to your floor, wall, and ceiling surfaces. Check for airborne moisture's effects on exposed wood, paper, and paint in the room. To minimize humidity damage, it is best to provide plenty of ventilation such as a ceiling fan and moisture-resistant paint. An architect can help to determine if special ventilation equipment is required, such as a humidistat or dehumidifier which can be installed to regulate indoor humidity during spa use. **NOTE:** Typical indoor surfaces include, but are not limited to concrete, wood, non-slip tile, or linoleum.

Outdoor Considerations: There are several considerations when installing your spa outdoors. 1. Avoid selecting a site where excessive water may contact the spa, such as sprinklers or a roof edge without rain gutters. 2. Avoid areas of direct, prolonged sunlight (if possible). The ultraviolet rays may fade or damage the spa cover and cabinet. 3. Check all applicable national and local codes regarding possible restrictions that require fencing or childproof gates around the spa. 4. Prevent dirt, sand, and foliage from being tracked into your spa by utilizing concrete, concrete pavers, or stone for paths and access areas (or, avoid positioning your spa in an area where debris will be tracked into the spa). Check the location of trees and spill paths from gutters to determine if wind or rain will sweep debris into your spa. 5. Consider your view and your privacy during all seasons of the year so your experience in your outdoor spa will be enhanced rather than limited. **NOTE:** Typical outdoor surfaces include, but are not limited to concrete, brick, non-slip tile, wood decking, pea gravel, or sand.

Spa Location

Service Access: Some people choose to install tile or custom wood around their spas. If you are installing your spa with

custom trimming, remember to allow access for service. Should your spa need service, a technician may need to remove the spa's equipment compartment door or side panels, or access the spa from beneath. Also, it is always best to design special installations so the spa can still be moved, or lifted from the ground.

Access to Circuit Breakers: For service purposes, allow easy access to the circuit breakers in the electrical service panel (permanently-connected models), or to the interrupter switch on the end of the power cord (cord-connected models).

Electrical Safety Requirements: The installation of all spas must be in accordance with national and local wiring rules. Always have a licensed Electrician perform the electrical installation. Each Bullfrog Spa and Tadpole Hot Tub is manufactured and tested to a standard that provides maximum protection against electrical shock. Improper wiring may prevent the spa from operating safely which could result in electrical shock, injury, or death. Improper wiring could also lead to a malfunction of the spa's equipment and risk of fire. When considering a location for your spa, consult with a licensed Electrician pertaining to the following:

- **Overhead Power Lines:** Based upon the national and local wiring rules that apply to your area, you will need to install your spa at the required minimum horizontal and vertical distances from all power lines.
- **Service Disconnect:** Based upon your area, a disconnect device must be incorporated into the fixed wiring in accordance with national and local wiring rules. If the national and local wiring rules permit, a GFCI Sub-Panel may be used to substitute the service disconnect, providing that it is located within the same parameters.
- **Electrical Outlets, Switches and Devices:** Based upon the national and local wiring rules that apply to your area, you must install your spa at the required minimum distance from all electrical outlets, switches, and devices.
- **Bonding:** Based upon the national and local wiring rules that apply to your area, the Control System Box located inside the equipment compartment of your spa must be bonded to all metal equipment, handrails, fixtures, enclosures, pipe, or conduit that are located within the maximum specified distances. The bonding is to be connected to the ground lug connector on the exterior surface of the Control System Box and all metal items previously described.
- **Equipment Compartment Access:** Make sure the spa is positioned so access to the equipment compartment will not be blocked.
- **All other national and local rules that may be applicable.**

Water Drainage: Avoid installing the spa in a pit or low area where water may accumulate and damage the spa or its equipment. Choose a site where water will drain away from the spa. Your spa contains an equipment compartment, which houses all of its electrical components. Allowing water into the equipment compartment can damage the electronics, or may result in tripping your spa's circuit breaker. For 120V~/60Hz, cord-connected spas, avoid plugging your spa into an electrical outlet that is susceptible to water. Likewise, avoid positioning the spa's electrical cord as to allow water to enter the cord's interrupter switch.

Use of a Cover-Lifting Mechanism: If using a cover-lifting mechanism, allow up to 24" (.61m) of clearance behind the spa. Check with your authorized Bullfrog Spa dealer for the exact clearance requirements for the cover-lifting mechanism.

Spa Foundation

General Guidelines: Select a structurally sound flat surface that is reasonably level to serve as your spa's foundation. A foundation that shifts or settles may cause stress to the spa shell. The foundation that your spa rests on must have a weight bearing load capability of supporting the weight of your spa, its water, and the people using it. The maximum filled weight of a spa can be as much as 6,000 lbs (2722kg), plus the weight of the occupants that use the spa (for the weight bearing load requirements as well as the maximum filled weight of your spa, refer to the *Spa Technical Specifications Chart* or contact your local authorized Bullfrog Spa dealer). If your spa's pad is slightly sloped it will not affect the performance of the spa or its structure, however, there should be no dips, sags, or unevenness in the pad. Most patios are built to slope away from the house for drainage purposes. There should be no more than a ½" (1.27cm) slope in an 8' (2.44m) run. Recommended flooring materials include a concrete pad, concrete pavers or bricks, wood railroad ties, pea gravel, or crushed rock (1.5" [3.81cm] or less), or a reinforced deck. Additionally, your authorized Bullfrog Spa dealer should sell or recommend pre-formed spa pads. **NOTE:** Concrete foundations should be a minimum of 4" (10.16cm) thick and should be reinforced with either rebar or mesh. For electrical grounding purposes, the rebar or mesh should be attached to a bond wire (see *Electrical Requirements and Installation Instructions*).

⚠WARNING: To prevent serious damage to your spa, it is important that the spa foundation be supported by a flat, stable, and consistent subsurface. Bullfrog International highly recommends consulting a qualified, licensed Contractor prior

to the installation of any spa foundation. For assistance, contact your authorized Bullfrog Spa dealer.

⚠WARNING: Because your spa pad must provide continuous support for the entire base of the spa, you should never level it with shims. If it is necessary to level your spa, make sure the entire spa's structure is fully supported, both in the center as well as the outer edge. When leveling your spa, there should be no voids beneath it. Contact your authorized Bullfrog Spa dealer before making any leveling adjustments. Structural damage to the spa resulting from incorrect installation, placement on an inadequate foundation, or improper leveling will void the spa's warranty.

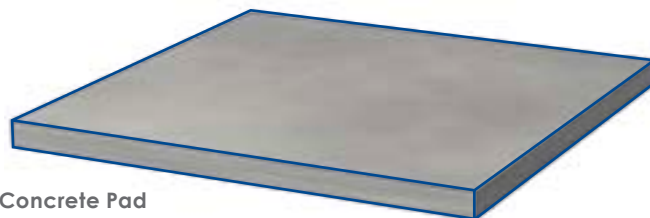

Concrete Pad

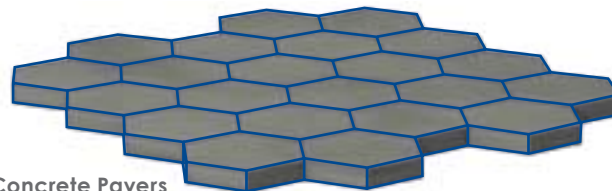

Concrete Pavers

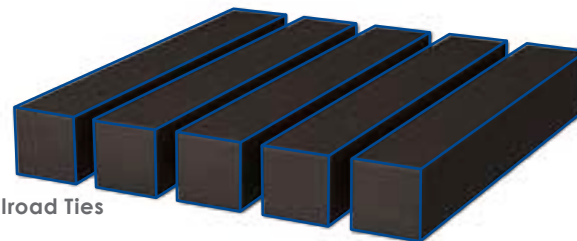

Railroad Ties

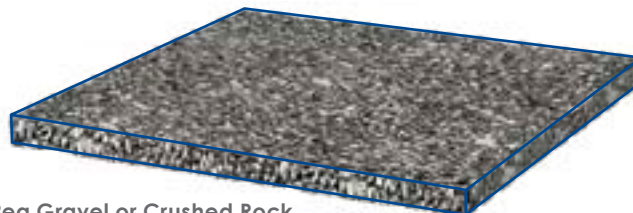

Pea Gravel or Crushed Rock

⚠CAUTION: Consult a qualified Structural Engineer or Contractor before the spa is placed on an elevated structure or deck.

Elevated Installations: Be certain your deck or elevated structure can support the maximum filled weight of your spa along with the total weight of occupants that use it. You must know the deck's weight-bearing load capacity and ensure that it is greater than the maximum filled weight of your spa combined with the occupants using it or serious injury or structural damage could result. To find the weight bearing load requirement along with the maximum filled weight of your spa, refer to the *Spa Technical Specifications Chart* or contact an authorized Bullfrog Spa dealer.

Design Considerations

Hard-Surface Options (Decking and Flooring): In addition to selecting a hard surface that meets the recommended safety and maintenance criteria, consider textures and colors that will assist in enhancing the aesthetics of the area in which your spa will be installed. The decision to match, contrast, or blend the hard surface colors and textures with those of your spa should only be made after carefully researching your options. The cost of a Landscape Architect may be money well spent.

Surrounding Landscape: The correct landscape around your spa will not only soften the adjacent hard surface areas, but will add life and much enjoyment to the environment. If the budget allows, you may want to consult with a Landscape Architect for expert advice.

Spa-Side Accessories: Besides selecting the correct hard surfaces and landscape around your spa, the addition of the proper spa-side accessories will provide just the finishing touch that you are looking for. Spa steps, benches, towel racks, planter boxes, or an outdoor fireplace are just a few of the items that can be considered when accessorizing your spa.



Delivery Basics

To prepare for the delivery of your spa, make sure the delivery path is clear and no obstructions are present. Obstacles such as overhanging tree limbs, awnings, protruding gas meters, water meters, and A/C units can prevent easy access. It may be necessary to remove a gate, part of a fence, or other items in order to dolly the spa to the desired location. If there are more than six consecutive stairs without a landing, you may be required to find another delivery path. Check the measurements on 90° turns to make sure the spa will fit through. Occasionally a crane is required to install the spa by lifting it to its final destination. This occurs when the spa has to be taken off of the dolly cart to go over a wall, either because the entry area is too narrow, the eaves are too low, the corner is too tight, or the stairway is too steep. The use of a crane is a common practice and is usually the easiest and

safest method for moving a spa when access is difficult. The crane has a truck-mounted boom and can fit easily in your driveway. The Crane Operator will lift your spa over walls, buildings, or any other obstruction and place it as close to the installation site as possible.

Depending on access to the spa site, your spa may be dollyed in either horizontal or vertical position. For your convenience, the following charts provide the dimensions of your spa in either the horizontal or vertical position. **NOTE:** The height of the cart used to dolly your spa into position will need to be added to the height of your spa when calculating the total height clearance required to complete your delivery. Spa carts are typically around 6" (15.24cm) in height. (If necessary, see your authorized Bullfrog Spa dealer for the exact height.)

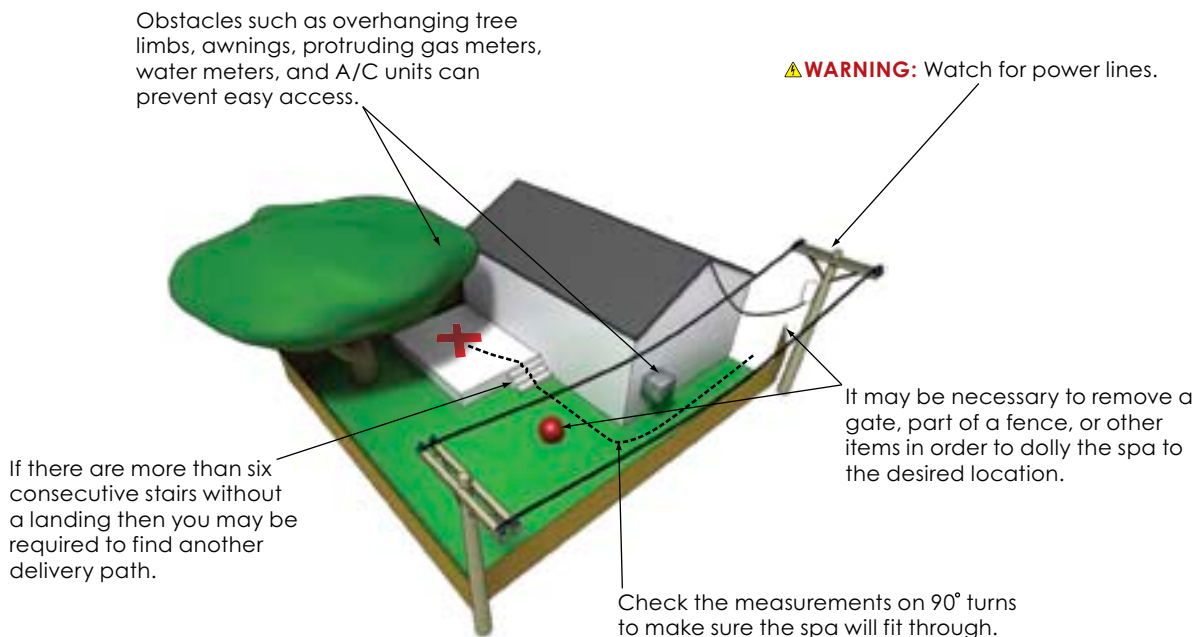

W: Width
L: Length
H: Height
D-H: Dolly Height
O-H: Overall Height
D: Cross Square

Spa Dimensions Chart (for Vertical Deliveries)

| Model | Width (W) | Length (L) | Height (H) |
|--------------|------------|----------------|----------------|
| Bullfrog 331 | 31" (.79m) | 6' 10" (2.09m) | 5' 6" (1.73m) |
| Bullfrog 451 | 35" (.89m) | 7' 4" (2.24m) | 6' 7" (2.01m) |
| Bullfrog 562 | 35" (.89m) | 7' 4" (2.24m) | 7' 4" (2.24m) |
| Bullfrog 552 | 35" (.89m) | 7' 10" (2.39m) | 7' 10" (2.39m) |
| Bullfrog 662 | 35" (.89m) | 7' 10" (2.39m) | 7' 10" (2.39m) |
| Bullfrog 682 | 35" (.89m) | 7' 10" (2.39m) | 7' 10" (2.39m) |
| Tadpole 251 | 35" (.89m) | 7' 4" (2.24m) | 6' 7" (2.01m) |
| Tadpole 362 | 35" (.89m) | 7' 4" (2.24m) | 7' 4" (2.24m) |

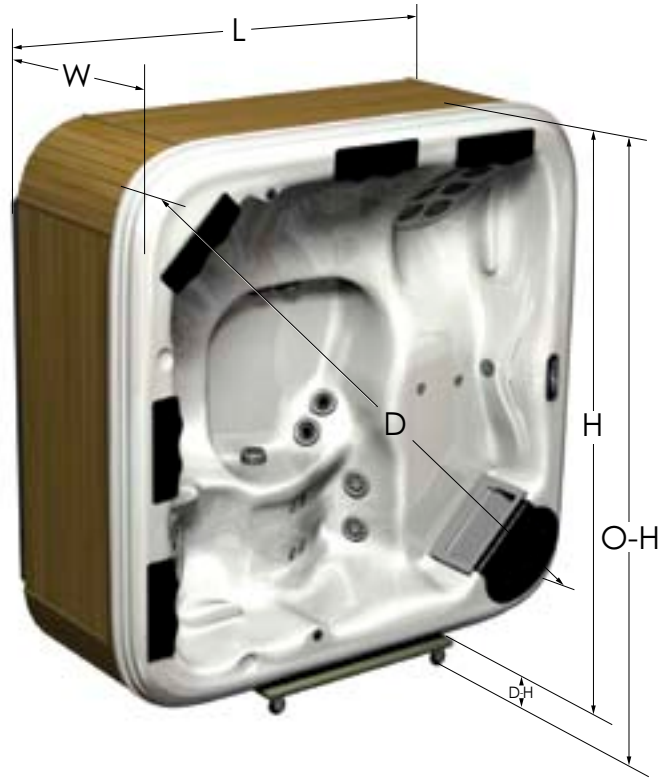

Installation and Setup



Spa Dimensions Chart (for Horizontal Deliveries)

| Model | Width (W) | Length (L) | Height (H) |
|--------------|----------------|----------------|------------|
| Bullfrog 331 | 5' 6" (1.73m) | 6' 10" (2.09m) | 31" (.79m) |
| Bullfrog 451 | 6' 7" (2.01m) | 7' 4" (2.24m) | 35" (.89m) |
| Bullfrog 562 | 7' 4" (2.24m) | 7' 4" (2.24m) | 35" (.89m) |
| Bullfrog 552 | 7' 10" (2.39m) | 7' 10" (2.39m) | 35" (.89m) |
| Bullfrog 662 | 7' 10" (2.39m) | 7' 10" (2.39m) | 35" (.89m) |
| Bullfrog 682 | 7' 10" (2.39m) | 7' 10" (2.39m) | 35" (.89m) |
| Tadpole 251 | 6' 7" (2.01m) | 7' 4" (2.24m) | 35" (.89m) |
| Tadpole 362 | 7' 4" (2.24m) | 7' 4" (2.24m) | 35" (.89m) |

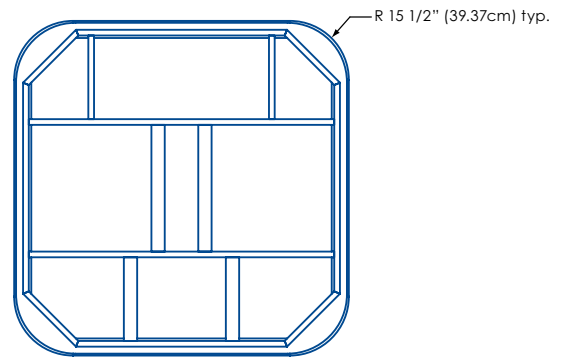
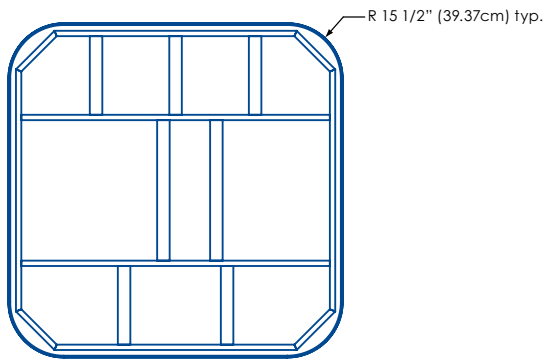
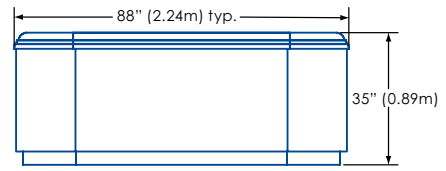
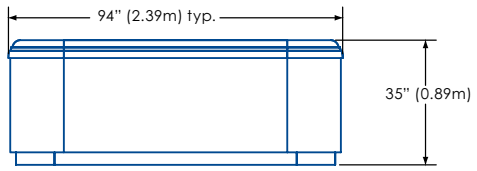

682, 662, 552

562, 362

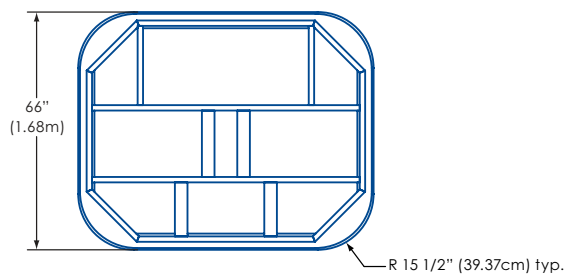
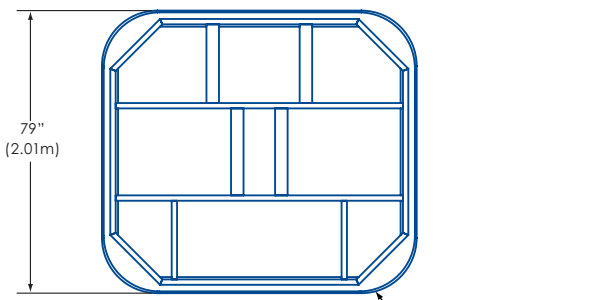
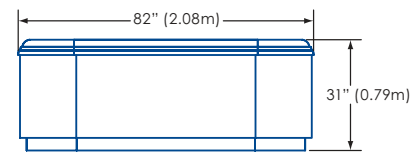
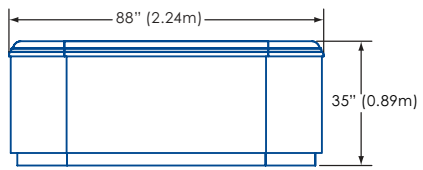

451, 251

331

NOTE: Toe kick sits approximately 1.5" (3.81cm) back from the cabinet on all sides.

Electrical Requirements and Installation Instructions

IMPORTANT: Provide a copy of these instructions to your Electrician.

INTRODUCTION

The installation of all spas must be in accordance with national and local wiring rules. Always have a licensed Electrician perform the electrical installation. Each Bullfrog Spa and Tadpole Hot Tub is manufactured and tested to a standard that provides maximum protection against electrical shock. Improper wiring may prevent the spa from operating safely which could result in electrical shock, injury or death. Improper wiring could also lead to a malfunction of the spa's equipment and risk of fire.

Important Technical Information

Voltage Definitions: When reading these instructions, the term 120V~ refers to the 110-120V~ range of voltage, while the 230V~ term refers to the 220-240 range of voltage.

Wiring Connection: Appliance must be permanently connected to fixed wiring (except for U.S./CAN 120V~/60Hz Cord-Connected units).

Wiring Diagrams: In addition to the instructions that follow, please reference the appropriate *Wiring Diagrams* (120V~/60Hz Cord-Connected, 120V~/60Hz Permanently-Connected, 230V~/60Hz Permanently-Connected, or 230V~/50Hz Permanently-Connected).

Electrical Service Wire Size and Type: The size of wire required to supply the spa with power is dependent upon the length of the electrical run and should only be determined by a licensed Electrician. Installation must be in accordance with all national and local wiring rules. All wiring must be copper to ensure adequate connections. Never use aluminum wire.

Spa Location:

- **Overhead Power Lines:** Based upon the national and local wiring rules that apply to your area, you will need to install your spa at the required minimum horizontal and vertical distances from all power lines.
- **Service Disconnect:** Based upon your area, a disconnect device must be incorporated into the fixed wiring in accordance with national and local wiring rules. If the national and local wiring rules permit, a GFCI Sub-Panel may be used to substitute the service disconnect, providing that it is located within the same parameters.

- **Electrical Outlets, Switches and Devices:** Based upon the national and local wiring rules that apply to your area, you must install your spa at the required minimum distance from all electrical outlets, switches, and devices.
- **Bonding:** Based upon the national and local wiring rules that apply to your area, the Control System Box located inside the equipment compartment of your spa must be bonded to all metal equipment, handrails, fixtures, enclosures, pipe, or conduit that are located within the maximum specified distances. The bonding is to be connected to the ground lug connector on the exterior surface of the Control System Box and all metal items previously described.
- **Equipment Compartment Access:** Make sure the spa is positioned so that access to the equipment compartment will not be blocked.

Ground Fault Circuit Interrupters (GFCI): As per national and local wiring rules, all spas, hot tubs, and associated electrical components must be protected by a GFCI, either at the main breaker box or at the service disconnect.

⚠WARNING: Removal or bypassing the GFCI will result in an unsafe spa and will void your spa's warranty. When installing the GFCI, all conductors except the green ground must be routed through the GFCI, including the neutral. Never bypass the neutral line. If the neutral line is bypassed, then the current will be imbalanced and cause the GFCI to trip. See *GFCI Wiring Diagrams* or contact Bullfrog International, LC or your authorized Bullfrog Spa dealer. **REQUIRED TEST PROCEDURE:** After the spa is first filled and turned on, and prior to each use, the GFCI should be tested as follows: **Step 1** press **Test** on the GFCI breaker. The spa should stop operating. **Step 2** after 30 seconds, press **Reset** and then verify that power has been restored to the spa. If the GFCI fails to operate in this manner you may have an electrical malfunction and be at risk of electrical shock. Should this occur, turn off the GFCI breaker to the spa and do not use the spa until the malfunction has been repaired by a licensed Electrician or your authorized Bullfrog Spa dealer.

Dedicated Electrical Circuit Breaker: The electrical service to the spa must include a suitably rated switch or circuit breaker. Whether the spa is a 120V~/60Hz Cord-Connected spa or a 120V~/60Hz, 230V~/60Hz or 230V~/50Hz Permanently-Connected spa, it is required that the circuit breaker that supplies power to the spa is dedicated and does not supply power to any other electrical outlet, device or item.

Electrical Access Conduit: Each Bullfrog Spa and Tadpole Hot Tub is manufactured with an electrical access conduit which allows the electrical supply wires to be connected to the spa's Control System Box. This access conduit is located in the front-left corner (when you are facing the spa's control pad) of the spa.

12V Maximum on Live Parts: Live parts accessible to the user must not exceed 12V.

230V~/60Hz 30A Conversion Option: If there is not 50A of electrical service available, an authorized Bullfrog Spa dealer or Electrician can easily convert the spa to operate on 30A (conversion instructions are located inside the Control System Box). Please be aware, spas converted to 30A are only capable of heating the water when pump 1 is in low-speed, not high-speed. This heating limitation is acceptable in most climates as well as indoor installations.

230V~/50Hz Conversion Options: If there is not 32A of electrical service available, an authorized Bullfrog Spa dealer or an Electrician can easily convert the spa to operate on either a single or dual 16A x2 service. Conversion instructions for the following configurations are located inside the Control System Box of the spa.

230V~/50Hz 16A Single Service: Please be aware, spas converted to 16A are only capable of heating the water when the circulation pump is in low-speed, not high-speed. This heating limitation is acceptable in most climates as well as indoor installations.

230V~/50Hz 16A, 16A Dual Service: Operation of spa is identical to single 32A service except that service is divided into two separate 16A services.

New Installations and Re-Installations: These instructions apply to both new installations and re-installations which may occur when a spa is moved or relocated to a new location.

120V~/60Hz or 230V~/60Hz Convertible Equipment (Model BF03-All U.S./CAN Single-Pump Spas only)

Single-Pump spas are equipped with voltage convertible equipment (Model BF03). Depending upon the pump installed, the BF03 equipment allows the spa to operate either on a 120V~/60Hz or 230V~/60Hz electrical service.

120V~/60Hz Pump: Spas equipped with a 120V~/60Hz pump can be 120V~/60Hz Cord-Connected, 120V~/60Hz Permanently-Connected, or 230V~/60Hz Permanently-Connected.

120V~/60Hz Cord-Connected Installation: This option is only applicable if the spa was ordered from the factory with both a 120V~/60Hz pump and a 120V~/60Hz power cord. The spa's Safety Approval Listing and warranty will be void, and the spa may be unsafe if an aftermarket power cord is installed on the spa. Cord-Connected spas have already been converted to operate on 120V~/60Hz power at the factory and come with approximately 15' (4.57m) of useable power cord (the maximum length allowed) attached to the spa. This factory installed power cord comes with a built-in GFCI breaker. **IMPORTANT:** Cordage shall be replaced only with a special cordage assembly available from the manufacturer, its service agent, or similarly qualified persons in order to avoid a hazard.

Cord-Connected 120V~/60Hz spas require that the factory installed power cord, with its built-in GFCI breaker be connected to a 120V~/60Hz, 20A, Single-Phase, dedicated, grounded circuit and power outlet. It is important that this circuit is dedicated (not being used by any other electrical appliance) or your spa may not function properly. For safety purposes, the location of the power outlet (where the spa is to be connected) can be no closer than the minimum allowable distance specified by the national and local wiring rules in your area. Installation must be in accordance with all national and local wiring rules.

Fill Spa before Powering on: Always fill the spa to the recommended level before turning on the power (see *Pre-fill Checklist*).

Residual Current Device: The appliance should be supplied through a residual current device with a rated tripping current not exceeding 30mA.

⚠ WARNING: Never use an extension cord. Bullfrog International, LC does not allow the use of an extension cord under any possible situation. The use of an extension cord voids any warranty on the spa equipment and also exposes the consumer to additional risk of fire, electrical shock, injury, or death.

120V~/60Hz Permanently-Connected Installation: Unless your spa was ordered from the factory with a 120V~/60Hz power cord, its equipment is configured to operate on 230V~/60Hz power (even though it was equipped with a 120V~/60Hz pump). Prior to the 120V~/60Hz electrical installation, the spa's equipment will need to be converted from its 230V~/60Hz configuration to a 120V~/60Hz

configuration. For specific conversion instructions, please refer to the system wiring diagram inside the Control System Box (located in the spa's equipment compartment).

Permanently-Connected 120V~/60Hz spas require a GFCI protected, 3-wire (Line 1, Neutral and Ground), 120V~/60Hz, 20A, Single-Phase, dedicated electrical circuit. It is important that this circuit is dedicated (not being used by any other electrical appliance) or the spa may not function properly. Installation must be in accordance with all national and local wiring rules.

230V~/60Hz Permanently-Connected Installation: Even though the spa is equipped with a 120V~/60Hz pump, it has already been configured to operate on 230V~/60Hz power unless the spa came with a factory connected 120V~/60Hz power cord, in which case the spa's equipment will need to be converted from its 120V~/60Hz configuration to the 230V~/60Hz configuration. For specific conversion instructions, please refer to the system wiring diagram inside the Control System Box (located in the spa's equipment compartment).

Permanently-Connected 230V~/60Hz spas require a GFCI protected, 4-wire (Line 1, Line 2, Neutral, and Ground), 230V~/60Hz, 50A, Single-Phase, dedicated electrical circuit. It is important that this circuit is dedicated (not being used by any other electrical appliance) or the spa may not function properly. Installation must be in accordance with all national and local wiring rules.

230V~/60Hz Pump: Spas equipped with a 230V~/60Hz pump can only be Permanently-Connected. 230V~/60Hz Permanently-Connected Installation: Your spa has been configured to operate only on 230V~/60Hz power.

Permanently-Connected 230V~/60Hz spas requires a GFCI protected, 4-wire (Line 1, Line 2, Neutral and Ground), 230V~/60Hz, 50A, Single-Phase, dedicated electrical circuit. It is important that this circuit is dedicated (not being used by any other electrical appliance) or the spa may not function properly. Installation must be in accordance with all national and local wiring rules.

230V~/60Hz Equipment (Model BF01-U.S./CAN Dual-Pump Spas) Dual-Pump spas are equipped with 230V~/60Hz pumps and 230V~/60Hz equipment (Model BF01). This 230V~/60Hz equipment allows the spa to operate only on a 230V~/60Hz electrical service.

Permanently-Connected 230V~/60Hz spas require a GFCI protected, 4-wire (Line 1, Line 2, Neutral and Ground), 230V~/60Hz, 50A, Single-Phase, dedicated electrical circuit.

It is important that this circuit is dedicated (not being used by any other electrical appliance) or the spa may not function properly. Installation must be in accordance with all national and local wiring rules.

230V~/50Hz EQUIPMENT (Model BF04-All European Spas) Spas are equipped with 230V~/50Hz pumps and 230V~/50Hz equipment (Model BF04). This 230V~/50Hz equipment allows the spa to operate only on a 230V~/50Hz electrical service.

Permanently-Connected 230V~/50Hz spas require a GFCI protected, 230V~/50Hz, 32A Single-Service, 16A Single-Service, or 16A – 16A Dual-Service, dedicated electrical circuit. It is important that this circuit is dedicated (not being used by any other electrical appliance) or the spa may not function properly. For specific conversion instructions, please refer to the system wiring diagram inside the Control System Box (located in the spa's equipment compartment). Installation must be in accordance with all national and local wiring rules.

Connecting the electrical service to the spa

IMPORTANT: Installation must be in accordance with all national and local wiring rules and performed by a licensed Electrician.

Step 1: Remove the equipment compartment door.

Step 2: Remove the faceplate to the Control System Box.

Step 3: Connect a 1" (2.54cm) non-metallic coupling and conduit to the 1" (2.54cm) male CPVC pipe found at the base of the spa cabinet (front left corner when facing the Master Control Pad).

Step 4: Run the required wires through the conduit to the Control System Box.

Step 5: Connect the electrical service wires to the terminal block located in the Control System Box.

Step 6: Replace the Control System Box faceplate and the equipment compartment door.

Step 7: The electrical hook-up is complete.

GFCI Wiring Diagrams

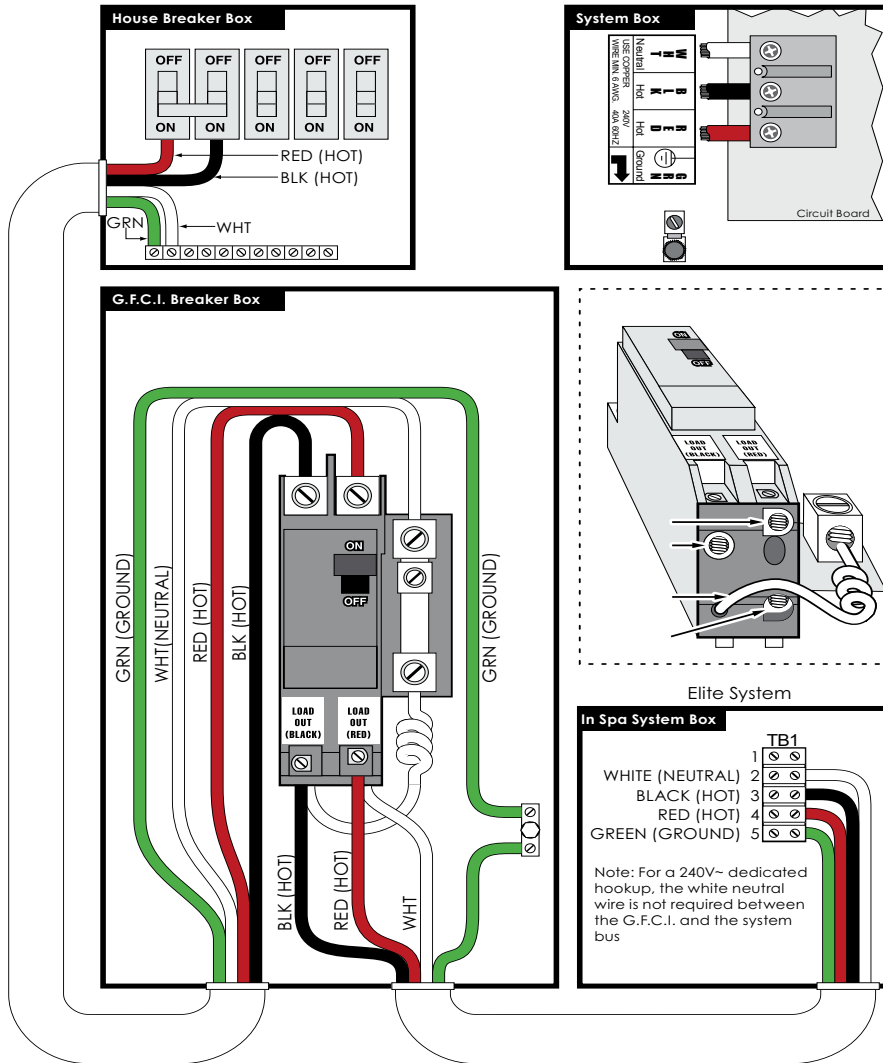

60Hz Install (typical) U.S./CAN
for BF01, BF02, and BF03

IMPORTANT: Installation must be in accordance with all national and local wiring rules and performed by a licensed Electrician.

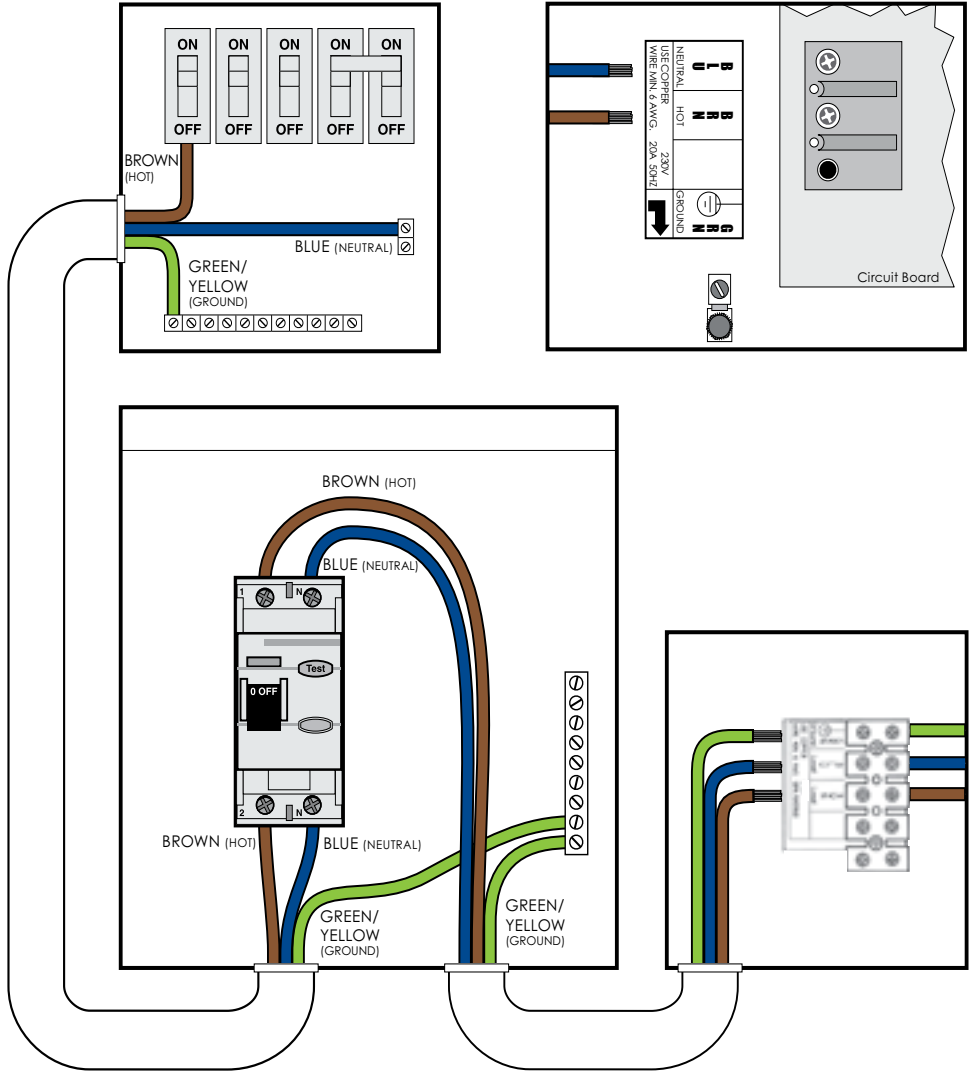

50Hz Install (typical) Europe/Australia for BF04

52847-04
MODEL BF01

Balboa Instruments Incorporated
BALBOA INSTRUMENTS INC. C
TUSTIN, CA

Certified to comply with the limits for a class B computing device pursuant to subpart J of part 15 of the FCC rules

60 HZ

MODEL: EL2-BF01-YCAH
PAT. NO. 4618797



HOW TO SET CIRC.PUMP BEHAVIOR
SELECT SWITCHES A9 & A10.
A-9 A-10

| | | |
|-------------------|-----|-----|
| NO CIRC. PUMP | OFF | OFF |
| 24-HOUR CIRC | ON | OFF |
| 3*SHUT OFF | OFF | ON |
| FILTER/POLLS ONLY | ON | ON |

'A' DIP SWITCH SETTINGS

| ALL UNUSED SWITCHES SHOULD BE OFF. | OFF | ON | MODE | OFF | ON |
|------------------------------------|-----------------|-----------|--------------------------------------|--------------------------|-------------------------------------|
| | NO | YES | TEST MODE | <input type="checkbox"/> | <input checked="" type="checkbox"/> |
| | LOW AMP. | HIGH AMP. | AMPERAGE SELECT | <input type="checkbox"/> | <input checked="" type="checkbox"/> |
| | TIME | DURT. | FILTER PROG. BY DURATION | <input type="checkbox"/> | <input checked="" type="checkbox"/> |
| | 12 Hr | 24hr | TIME DISPLAY IN 24HR | <input type="checkbox"/> | <input checked="" type="checkbox"/> |
| | Deg F* | Deg C* | DEG F*/C* | <input type="checkbox"/> | <input checked="" type="checkbox"/> |
| | 15min | 30min | PUMP TIMEDOUT P1-L TIMEDOUT | <input type="checkbox"/> | <input checked="" type="checkbox"/> |
| | 2HR | 4HR | PUMP TIMEDOUT | <input type="checkbox"/> | <input checked="" type="checkbox"/> |
| | NO | YES | CLEANUP CYCLE | <input type="checkbox"/> | <input checked="" type="checkbox"/> |
| | NO | YES | O3 SUPPRESSED FOR 1 HR | <input type="checkbox"/> | <input checked="" type="checkbox"/> |
| | SEE TABLE ABOVE | | CIRC.PUMP BEHAVIOR | <input type="checkbox"/> | <input checked="" type="checkbox"/> |
| | NO | YES | CIRC.PUMP BEHAVIOR | <input type="checkbox"/> | <input checked="" type="checkbox"/> |
| | NO | YES | CIRC. P1 ISPD NO. IS IN FLTR | <input type="checkbox"/> | <input checked="" type="checkbox"/> |
| | STORE | RESET | PANEL BUTTON PERSISTENT MEMORY RESET | <input type="checkbox"/> | <input checked="" type="checkbox"/> |

'B' DIP SWITCH SETTINGS

| ALL UNUSED SWITCHES SHOULD BE OFF. | OFF | ON | MODE | OFF | ON |
|------------------------------------|------|------|----------------------------|--------------------------|-------------------------------------|
| | 2SPD | ISPD | P-2 2SPD/ISPD | <input type="checkbox"/> | <input checked="" type="checkbox"/> |
| | NO | YES | P-2 ENABLE | <input type="checkbox"/> | <input checked="" type="checkbox"/> |
| | OFF | ON | BLOWER ENABLE | <input type="checkbox"/> | <input checked="" type="checkbox"/> |
| | OFF | ON | F.I.L INSTEAD OF SPA LIGHT | <input type="checkbox"/> | <input checked="" type="checkbox"/> |
| | NO | YES | F.I.L INSTEAD OF SPA LIGHT | <input type="checkbox"/> | <input checked="" type="checkbox"/> |
| | OFF | ON | PANEL BUTTON BOUNCING | <input type="checkbox"/> | <input checked="" type="checkbox"/> |

BF01 Wiring Diagram

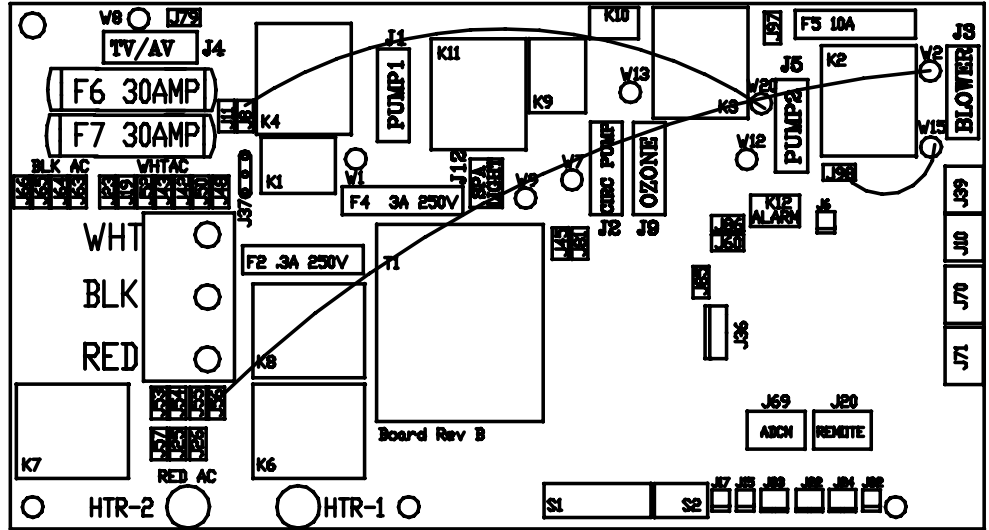

| LOCATION | DEVICE | VOLTAGE | RATING | CONNECT FROM | CONNECT TO |
|----------|-----------|---------|--------|--------------|------------|
| J1 | 2 SPD P1 | 240V | | W1 | J53 |
| J5 | 2 SPD P2 | 240V | | W12 | J55 |
| J9 | OZONE | 120V | | W15 | J98 |
| J4 | TV/AV | 120V | | W13 | J50 |
| J2 | CIRC PUMP | 240V | | W7 | J26 |
| J12 | SPA LIGHT | 12V | 12W | W9 | J45 |
| HTR1-2 | HEATER | 240V | 5.5KW | | |

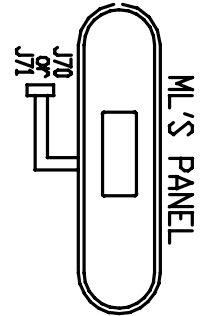

MANUFACTURE DIP SWITCH 'A' SETTINGS

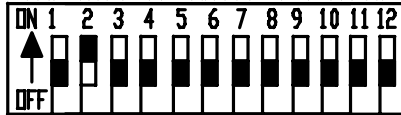

MANUFACTURE DIP SWITCH 'B' SETTINGS

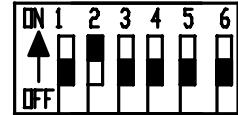

Ratings:

230V~, 48A, 60Hz

BF02/03 Wiring Diagram

P/N 53316-03
MODEL BF02-BF03



BALBOA INSTRUMENTS INC. C
TUSTIN, CA. 92680
Certified to comply with the limits for a class B computing device pursuant to subpart J of part 15 of the FCC rules. 60 HZ

MODEL: EIP-BF03-DCAH
PAT. NL 4618797



BALBOA INSTRUMENTS INCORPORATED
09/01/04

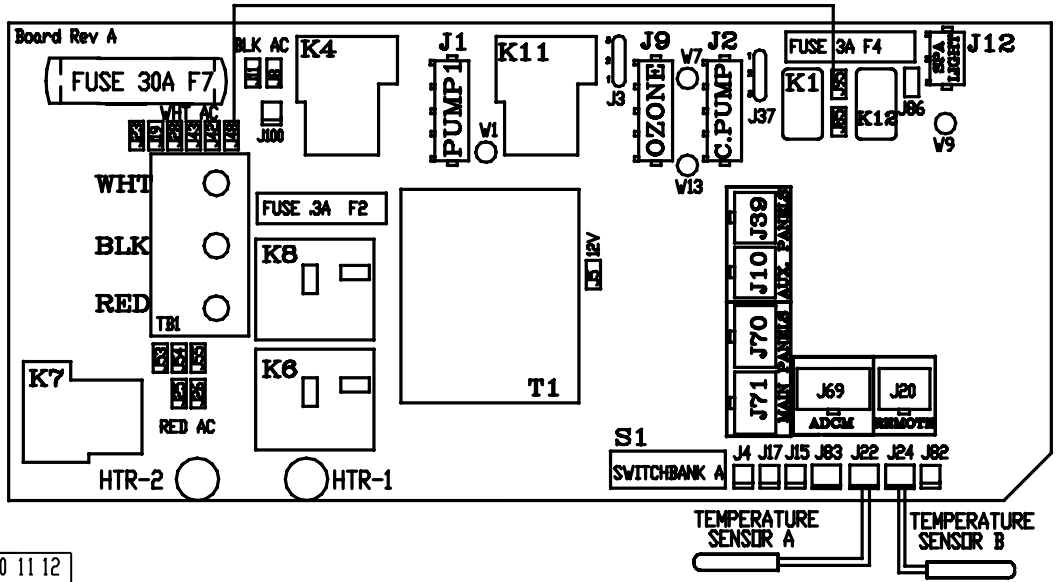
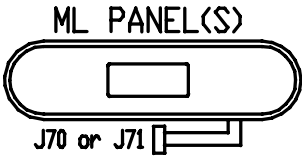

A DIP SWITCH SETTINGS

| ON | 1 | 2 | 3 | 4 | 5 | 6 | 7 | 8 | 9 | 10 | 11 | 12 | | |
|------|--------------------------|--------------------------|--------------------------|--------------------------|--------------------------|--------------------------|--------------------------|--------------------------|--------------------------|--------------------------|--------------------------|-----------------------------|---------------|--------------------------|
| OFF | <input type="checkbox"/> | <input type="checkbox"/> | <input type="checkbox"/> | <input type="checkbox"/> | <input type="checkbox"/> | <input type="checkbox"/> | <input type="checkbox"/> | <input type="checkbox"/> | <input type="checkbox"/> | <input type="checkbox"/> | <input type="checkbox"/> | <input type="checkbox"/> | | |
| MODE | TEST MODE | HIGH AMPERAGE SELECT | FILTER PROG. BY DURATION | TIME DISPLAY | 24Hr IN 4HR | DEG F/ DEG C | PUMP TIMEOUT | P1-L TIMEOUT | CLEANUP CYCLE | SWP. ENABLE | NON CIRC/ 24HR CIRC | BLOWER ENABLE IF P2 DISABLE | CIRC. P1 ISPD | STORE RESET MEMORY RESET |
| ON | YES | HIGH AMP. | DURT. | 24Hr | 12Hr | 15min | 30min | 4HR | NO | NO | NON | NO | NO | NO |
| OFF | NO | LOW AMP. | TIME | 12Hr | DEG F* | 30min | 2HR | NO | NO | NO | NON | NO | NO | NO |

ALL UNUSED SWITCHES SHOULD BE OFF

| LOCATION | DEVICE | VOLTAGE | RATING | CONNECT FROM | CONNECT TO |
|----------|------------|---------|--------|--------------|------------|
| J1 | 2 SPD P1 | 240V | | W1 | J55 |
| J9 | OZONE | 240V | | W13 | J86 |
| J12 | SPA LIGHT | 12V | 12W | W9 | J5 |
| J2 | CIRC. PUMP | 240V | | W7 | J26 |
| HTR1-2 | HEATER | 240V | 5.5Kw | | |

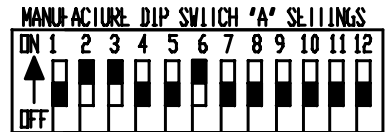

Ratings:

120V~230V, 16/A, 40A

120V~230V~ Heater Conversion Instrumtions

- Step 1:** Conversion must be performed by a qualified, licensed Electrician. Hardware only.
- Step 2:** Disconnect from power and remove wire/cord.
- Step 3:** Remove wire connected to J23 and J53 completely and discard.
- Step 4:** Install 230V~ power line to TB1 terminal block.
- Step 5:** Set dip switch 2 to "on" position.

If this unit is to be permanently-connected, connect only to a circuit that is protected by a ground fault circuit interrupter (GFCI).

P/N 53800
 MODELL MODELE
 MODEL BF04



Balboa Instruments Incorporated
 TUSTIN, CA. 50 Hz IPX5

CE

MODELL:
 MODELLE: GL2-BF04-RCA-3.0K
 MODEL:

PAT. NO. 4618797
 (FABRIQUE AUX ETATS-UNIS)

BF04 Wiring Diagram

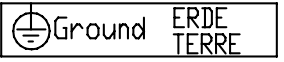

| | | |
|--|--------------|----------------|
| FACTORY DEFAULT | BROWN LINE 1 | BLUE NEUTRAL 1 |
| 230V 1~/16A-32A 1 SERVICE W/JUMPER A,B,C | BROWN LINE 2 | BLUE NEUTRAL 2 |
| | BROWN LINE 1 | BLUE NEUTRAL 1 |
| 230V 1~/2x16A 2 SERVICES. REMOVE JUMPER A | BROWN LINE 3 | BROWN LINE 2 |
| | BROWN LINE 1 | BLUE NEUTRAL |
| 400V 3~/16A 3 PHASE. REMOVE JUMPER A&B MOVE JUMPER C TO (J95-J28) | | |

| AC SERVICE TYPE | WIRE JUMPERS A, B & C | | |
|---------------------------|-----------------------|---------------|----------------|
| | A WIRE (WHITE) | B WIRE (BLUE) | C WIRE (BROWN) |
| 230V 1~/16A-32A 1 SERVICE | J26 TO J28 | J57 TO J28 | J32 |
| 230V 1~/2x16A 2 SERVICES | REMOVE | J57 TO J28 | J32 |
| 400V 3~/16A 3 PHASE | REMOVE | REMOVE | J28* |



Balboa Instruments Incorporated
 04/28/05

Netzstromversorgung
 2-geschw.-Pumpe1
 Alimentation
 Pompe1 A 2 Vitesses
 2 SPEED PUMP1

Netzstromversorgung
 2-geschw.-Pumpe2
 Alimentation
 Pompe2 A 2 Vitesses
 2 SPEED PUMP2

Circ. Pump
 Pompe De Circulation
 Kreislauf Pumpe

Ozongenerator
 Generateur D'Ozone
 Ozone Generator

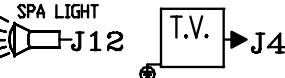
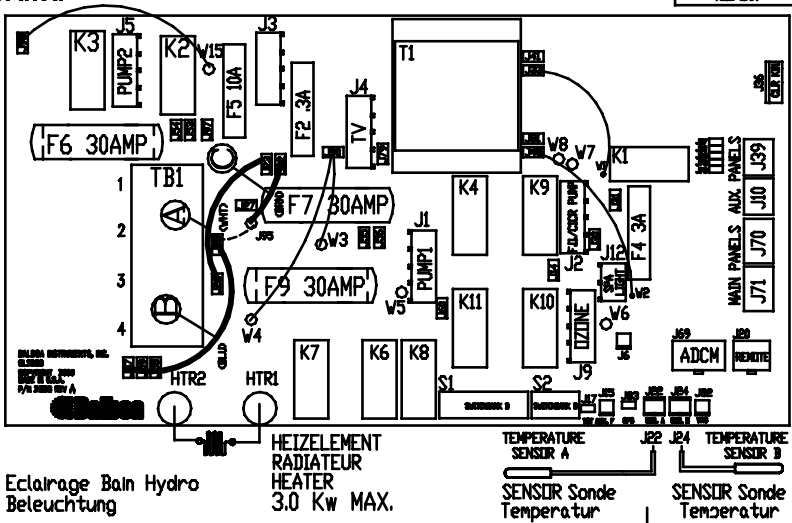

| 10V & 230V SPA LIGHT/FIL LIGHT CONFIGURATION | |
|--|--|
| 10V SPA LIGHT = V1-J33 & V2-J45 | |
| 230V SPA LIGHT = V1-J56 & V2-J60 | |
| 230V FIL = V1-J56, V2-J60 & SHORTED J30-J31 | |

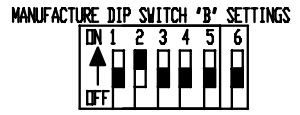
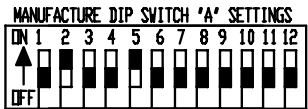
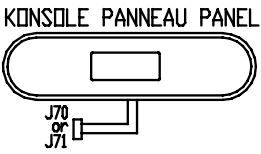

HOW TO SET CIRCPUMP BEHAVIOR
 SELECT SWITCHES A9 & A10

| | | |
|-------------------|-----|-----|
| NO CIRCPUMP | OFF | OFF |
| 24-HOUR CIRC | ON | OFF |
| 3PHSHUT OFF | OFF | ON |
| FILTER/POLLS ONLY | ON | ON |

→ V/ A9 MUST BE 'OFF'

'A' DIP SWITCH SETTINGS

| ON | 1 | 2 | 3 | 4 | 5 | 6 | 7 | 8 | 9 | 10 | 11 | 12 |
|------|-----------|-----------------------|--------------------------|----------------------|--------------|----------------------------|---------------|------------------------|-----------------|-------------------|--------------------------------|----------------|
| MODE | TEST MODE | HIGHT AMPERAGE SELECT | FILTER PROG. BY DURATION | TIME DISPLAY IN 24HR | C° DEG F°/C° | PUMP TIMEOUT P-L L TIMEOUT | CLEANUP CYCLE | D3 SUPPRESSED FOR 1 HR | SEE TABLE ABOVE | CIRCPUMP BEHAVIOR | CIRC. P1 SPD. INC. D3 IN FILTR | RECOVERY RESET |
| ON | YES | NO | NO | 12HR | F° | 30min 20R 4HR | NO | NO | NO | NO | NO | NO |
| OFF | NO | LOW AMP. SELECT | NO | 24HR | F° | NO | NO | NO | SEE TABLE ABOVE | NO | NO | NO |

'B' DIP SWITCH SETTINGS

| ON | 1 | 2 | 3 | 4 | 5 | 6 |
|------|--------------|------------|---------------|---------------------------|------------|----------------|
| MODE | P-2 2SPD/SPD | P-2 ENABLE | BLOWER ENABLE | F.O. INSTEAD OF SPA LIGHT | P-3 ENABLE | RECOVERY RESET |
| ON | ISPD | YES | YES | NO | NO | NO |
| OFF | 2SPD | NO | NO | NO | NO | NO |

ALL UNUSED SWITCHES SHOULD BE OFF

ALL UNUSED SWITCHES SHOULD BE OFF.

Ratings:
 230V~, 16/32A
 230V~, 16A x2

Bullfrog Spa & Yard™ Stereo Door Wiring Diagram

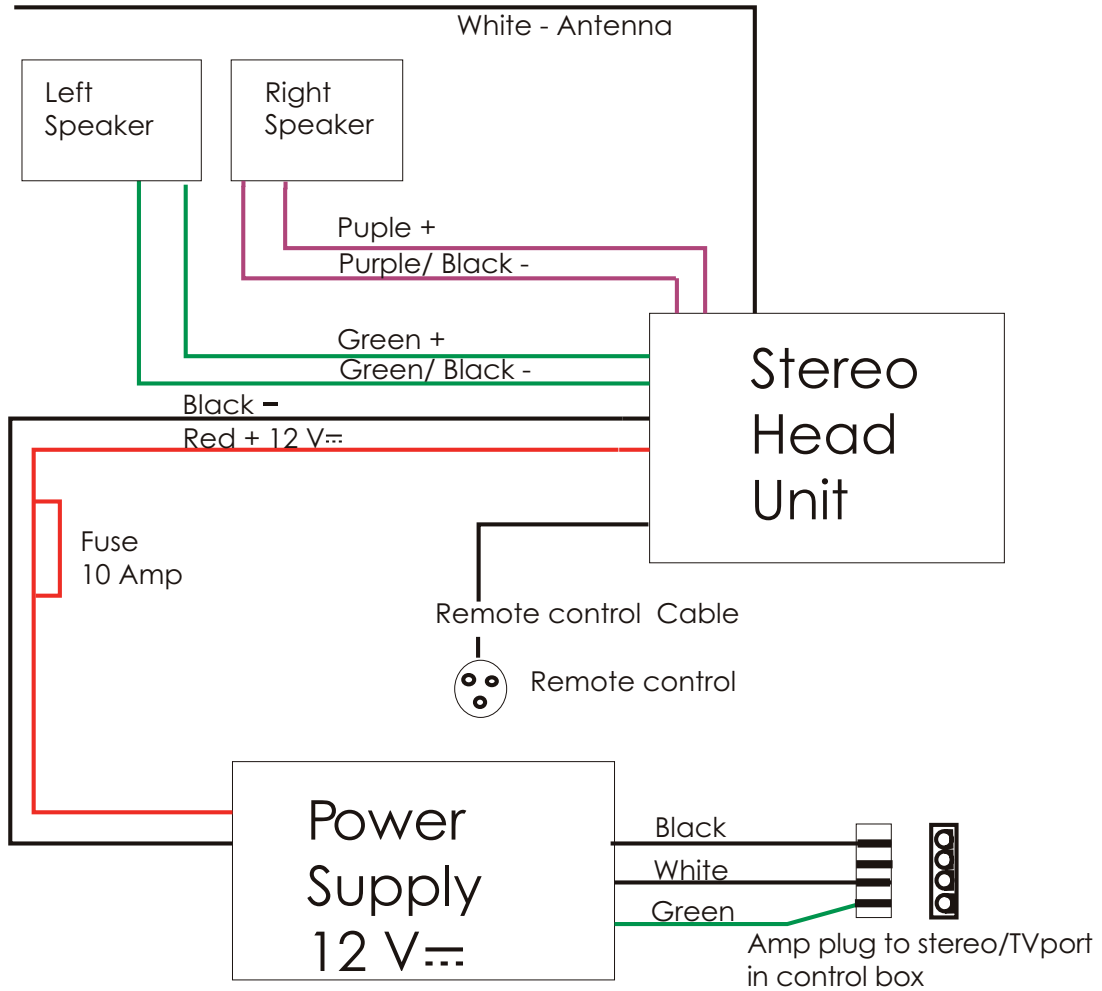

Ratings:

U.S./CAN: 100-127V~ .90A 60Hz

Europe: 200-240V~ 3.15A 50Hz

Output: 12V_{DC}=5A

Pre-Fill Checklist

Important: The equipment should never be operated without water in the spa. Serious damage to the pump and heater may occur.



Step 1: Check Drain Cap: There is a drain cap included in the Owner's Packet. Make sure this drain cap is securely tightened to the end of the drain hose.

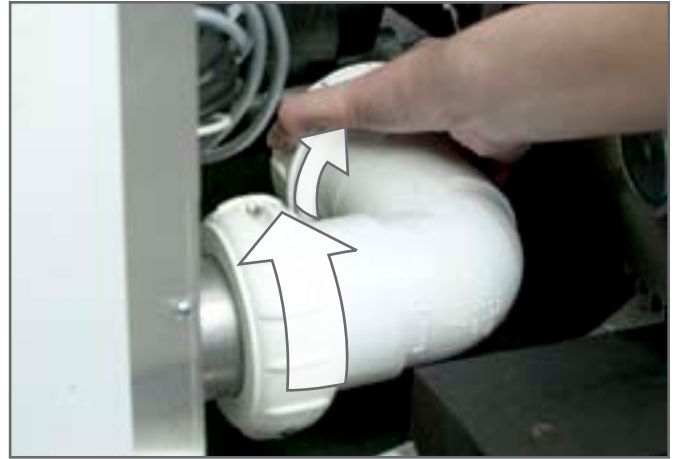

Step 2: Tighten Equipment Fittings: Hand tighten all PVC pipe unions located in the equipment compartment. This will prevent the possibility of a leak. **NOTE:** Fittings can loosen during shipment.



Step 3: Check Slice Valve Keepers: Verify that a slice valve keeper is installed on each slice valve. Slice valve keepers prevent the slice valve from vibrating shut during shipment or operation. A slice valve that closes will result in a noisy pump due to the lack of water flow. **NOTE:** Slice valves are not installed on the Tadpole 251 or Tadpole 362. For all Tadpole models, omit this step.



Step 4: Fill the Spa: Fill the spa to the water level indication mark on the faceplate of the filter assembly by placing the hose into the filter compartment through the Weir door. **NOTE:** The higher the water level in the spa, the fewer spa users the spa will accommodate before overflowing. **NOTE:** For complete instructions on filling the spa, refer to *Changing Spa Water*.

IMPORTANT: Never fill the spa with soft water unless an appropriate mineral supplement is immediately added (see your authorized Bullfrog Spa dealer). If your water is extremely hard, it is preferable to either dilute the water's hardness by blending the water with water from a water softener, or by the addition of a special water softening chemical (see your authorized Bullfrog Spa dealer).

IMPORTANT: Air pockets can result inside the pumps and in the main plumbing intake if the spa is not filled through the filter compartment.



Step 5: Check for Leaks: After the spa is filled, check all fittings and equipment for signs of leakage **before** turning on the spa. Turn on pump(s), once again, check for leakage. If a leak is detected, tighten the fitting by hand. If the leak persists contact your authorized Bullfrog Spa dealer.



Step 6: Install Cover: The spa cover comes with tie-down straps and locking hardware that attaches the cover to the spa or decking. If your dealer did not install the cover, refer to the Cover Installation Instructions included with the cover.

Operation

Control System

IMPORTANT: Each Bullfrog Spa is manufactured with either a Select or Premier Control System. Each Tadpole Hot Tub is manufactured with a Basic Control System. Refer to the Control System that applies to your spa.

⚠WARNING: This equipment generates and uses radio frequency energy and if not installed and used properly, that is, in strict accordance with the manufacturer's instruction, may cause interference to radio and television reception. It has been type tested and found to comply with the limits for a Class B computing device in accordance with the specifications in subpart j of part 15 of the FCC rules, which are designed to provide reasonable protection against such interference in a residential installation. However, there is no guarantee that interference will not occur in a particular installation. If this equipment does cause interference, which can be determined by turning the equipment on and off, the user is encouraged to try to correct the interference by one or more of the following measures: Reorient the receiving antenna. Relocate the receiver with the respect to the spa. Move the receiver away from the spa. Plug the receiver into a different outlet so the receiver and spa are on different branch circuits and if necessary, consult your authorized Bullfrog Spa dealer or an experienced Radio/Television Technician for additional suggestions. You may find the following booklet prepared by the Federal Communications Commission helpful, *How to Identify and Resolve Radio-TV Interference Problems*. This booklet is available from the U.S. Government Printing Office, Washington, DC 20402, and stock number 004-000-00345-4.

Select and Basic Control Systems

General

The pump responsible for heating and filtration is pump 1. Timeouts refer to a preset length of time that a function is programmed to operate before shutting off automatically. Certain conditions (filter or freeze) can cause a function to operate longer, while faults can cause a function to operate for a shorter length of time. The system keeps track of timeouts regardless of other conditions. **NOTE:** In multi-button sequences (shown by the + sign), if subsequent buttons are pressed too quickly the desired result may not occur.

Initial Startup

Before turning on the power to the spa, make sure the spa is properly filled with water and the equipment door has been secured. When your spa is first actuated, it will begin the Priming mode. The Priming mode will last for up to 4 minutes,

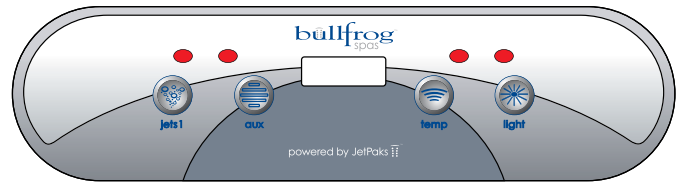

Select Control System One Pump

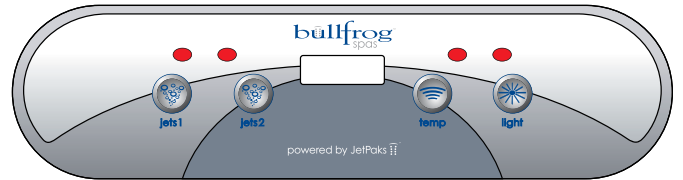

Select Control System Two Pumps



Basic Control System

and then the control system will begin to heat the spa and maintain the water temperature in the Standard mode. Press **temp** to exit the Priming mode early.

Temp Set: 80°F-104°F (26°C-40°C)

The startup temperature is set to 100°F (38°C). The last measured temperature is constantly displayed on the Liquid Crystal Display (LCD). **NOTE:** The spa temperature displayed is only current when the pump has been running for at least 2 minutes.

Press **temp** once to display the set temperature. To change the set temperature, press **temp** a second time before the LCD stops flashing. Press **temp** additional times to increase or decrease the set temperature. After 3 seconds, the LCD will automatically display the last measured temperature.

NOTE: To reverse the temperature adjustment direction, pause 3-5 seconds between pressing **temp**.

Spa Operating Modes

A multi-button sequence is used to switch between Standard, Economy, and Sleep modes. Press **temp + light** to enter mode programming. Press **temp** to cycle through to desired mode, then press **light** to confirm selection.

- **Standard Mode (Std):** maintains the desired temperature of the spa. Std will appear on the display momentarily when you switch into Standard mode.
- **Economy Mode (Ecn):** heats the spa to the set temperature only during filter cycles. Ecn will appear solid in the display when the spa is heating and will flash intermittently when the spa is not heating. Press **jets 1** while in Economy mode to place the spa in Standard-In-Economy mode (SE), which operates the same as Standard mode, however; it will revert to Economy mode automatically after 1 hour.
- **Sleep Mode (SLP):** heats the spa to within 20°F (11°C) of the set temperature only during filter cycles. SLP will appear on the display until the mode is changed.

Standby Mode (Sby)

Standby Mode idles all of the spa's functions. This is helpful when changing a filter or a JetPak. Press **temp** then **jets 2** or **aux** to start mode. Press any button to exit this mode.

Jets 1

Press **jets 1** to turn pump 1 on and off and to shift between low and high speeds. If left running, the low speed will turn off after 4 hours and the high speed will turn off after 30 minutes. When the low speed turns on automatically, it cannot be turned off from the control panel.

NOTE: When in standard mode, the low speed of pump 1 may activate for at least 2 minutes every 30 minutes to detect the spa temperature and will heat to set temperature (if needed).

Jets 2 (optional)

With a two pump system, press **jets 2** to turn pump 2 on or off and to shift between low and high speeds. If left running, the pump will turn off automatically after 15 minutes. **NOTE:** If the spa does not have two pumps, the **jets 2** button will be labeled **aux**.

Auxiliary Jet(s) Control

An optional auxiliary control pad(s) on the side of the spa can also activate the pump(s). **NOTE:** This option is not available on Tadpole Hot Tub models.



Light

Press **light** to toggle the light on and off. The light will turn off automatically after 4 hours.

LED Light (optional)

Press **light** to toggle the LED light on and off. Press **light + light** to shift through the color options. The light will turn off automatically after 4 hours.

Preset Filter Cycles

The pump and ozone purifier* will run during filtration. At the start of each filter cycle, pump 2 will run for 5 minutes to clean out the JetPaks™ and JetPods™ associated with pump 2. There are two filter cycles per day. The first filter cycle begins 6 minutes after the spa is powered up. The second filter cycle begins 12 hours later. Filter duration is programmable for 1-12 hours (F1-F12). The default filter time is 2 hours per cycle.

To program, press **temp + jets 1**. Press **temp** to select the filter duration. Press **jets 1** to select the number of filter cycles. The display will show dn (day and night), d (day only), or n (night only). Press **temp** to adjust. Press **jets 1** to exit the program. For continuous filtration, use F12 and dn. **NOTE:** Allowing the filter pump to operate for extended periods of time with the cover on the spa will result in a rise of the spa water temperature. During warmer months of the year, it is advisable to set the duration of the filtration cycle to the minimum level needed to keep the water clean.

Freeze Protection

If the temperature drops to 44°F (7°C) within the heater, the pump automatically activates to provide freeze protection. The pump will stay on 4 minutes after the sensor has detected the temperature has reached 45°F (7°C) or higher.

Cleanup Cycle (optional)

A cleanup cycle begins 30 minutes after the pump is turned off or times out. The pump and ozone purifier* will run for 1 hour. **NOTE:** To activate this feature, contact your authorized Bullfrog Spa dealer.

*Ozone Purifier (optional)

The ozone purifier runs during filter cycles (except when pump 1 is operating on high speed or when pump 2 is running on any speed) and during clean-up cycles.



Premier Control System (Bullfrog Spa models only)

General

The pump responsible for heating and filtration is pump 1. Timeouts refer to a preset length of time that a function is programmed to operate before shutting off automatically. Certain conditions (filter or freeze) can cause a function to operate longer, while faults can cause a function to operate for a shorter length of time. The system keeps track of timeouts regardless of other conditions. **NOTE:** In multi-button sequences (shown by the + sign), if subsequent buttons are pressed too quickly the desired result may not occur.

Initial Startup

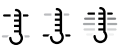
Before turning on the power to the spa, make sure the spa is properly filled with water and the equipment door has been secured. When your spa is first actuated, it will begin the Priming mode. The Priming mode will last for up to 4 minutes, and then the control system will begin to heat the spa and maintain the water temperature in the Standard mode. Press **warmer** or **cooler** to exit the Priming mode early.

| Icon Legend | |
|---|--|
|  | Heat Icon - Indicates different stages of heating. |
|  | Jets Icon - Spins fast on high speed/spins slow on low speed |
|  | Light Icon |

Setting the Time

Once the spa has been properly connected the TIME icon will appear on the control panel's liquid crystal display (LCD). Press **time + mode/prog**. Select the hour by pressing **warmer** or **cooler**. (Each press changes the time by 1 hour.) Press **mode/prog** to switch to minutes. Select minutes by pressing **warmer** or **cooler**. (Each press changes the time by 1 minute.) Press **time** to confirm. Press **mode/prog** to exit the time setting procedure and enter the optional filter cycle programming. Press **mode/prog** to exit programming.

NOTE: Time settings are not preserved in the event of a power loss.

Filter Cycles

NOTE: At the start of each filter cycle, the lowest speed of pump 2 will run for 5 minutes to clean out the JetPaks™ and JetPods™ associated with pump 2. **NOTE:** Allowing the filter pump to operate for extended periods of time with the cover on the spa will result in a rise of the spa water temperature.



Premier Control System One Pump



Premier Control System Two Pumps

During warmer months of the year, it is advisable to set the duration of the filtration cycle to the minimum level needed to keep the water clean. **NOTE:** The pump and ozone purifier* will run during filtration.

Preset Filter Cycles: Your spa came programmed from the factory with these defaults. There are two filter cycles per day. The first filter cycle will automatically activate at 8:00 a.m. and will operate for 2 hours. The second filter cycle will automatically activate at 8:00 p.m. and will operate for 2 hours. The start and end times of the filter cycles are programmable. To program, set time as instructed in *Setting the Time* and follow the instructions in *Custom Filter Cycles*.

Custom Filter Cycles: To program custom filter cycle settings, press **time + mode/prog + mode/prog + mode/prog** within 3 seconds. The PROGRAM, FILTER 1, and START TIME icons will appear on the display. Press **warmer** or **cooler** to choose the filter start time hour. Press **mode/prog** to enter the hour. Press **warmer** or **cooler** to choose the filter start time minutes. Each press changes the start time by 5 minutes. Press **mode/prog** to enter the minutes. Press **mode/prog** to see the PROGRAM, FILTER 1, and END TIME icons. Adjust the time as done above. Press **mode/prog** to see the PROGRAM, FILTER 2, and START TIME icons. Proceed as above. Press **mode/prog** to see PROGRAM, FILTER 2, and END TIME icons. Adjust the time as previously stated. Press **mode/prog** to enter the new filter cycle times into the system and display the current water temperature. Press **time** at any time during this programming sequence to save the values entered up to that point and exit programming.

Temp Set: 80°F-104°F (26°C-40°C)

The startup temperature is set to 100°F (38°C). The last measured temperature is constantly displayed on the LCD.

NOTE: The spa temperature displayed is only current when the pump has been running for at least 2 minutes.

Press **warmer** or **cooler** once to display the set temperature. Press **warmer** or **cooler** again to increase or decrease the temperature. After three seconds, the LCD will automatically display the last measured spa temperature.

Spa Operating Modes

A multi-button sequence is used to switch between Standard, Economy, and Sleep modes. Press **mode/prog** to enter mode, press **cooler** to cycle through modes, press **mode/prog** to confirm selection.

- **Standard Mode (Std):** maintains the desired temperature. The Standard icon will display.
- **Economy Mode (Ecn):** heats the spa to the set temperature only during filter cycles. Press **jets 1** while in Economy mode to put the spa in Standard-In-Economy mode (SE), which operates the same as Standard mode, however, it will revert to Economy mode automatically after 1 hour. The Economy icon will display.
- **Sleep Mode (SLP):** heats the spa to within 20°F (11°C) of the set temperature during filter cycles only. The Sleep icon will display.

Standby Mode (Sby)

Standby Mode idles all of the spa's functions. This is helpful when changing a filter or a JetPak. Press **temp** then **jets 2** or **aux** to start mode. Press any button to exit this mode.

Jets 1

Press **jets 1** to turn pump 1 on and off and to shift between low and high speeds. The low speed will turn off after 4 hours and the high speed will turn off after 30 minutes. When the low speed turns on automatically, it cannot be turned off from the control panel. **NOTE:** When in standard mode, the low speed of pump 1 may activate for at least 2 minutes every 30 minutes to detect the spa temperature and will heat to set temperature if needed.

Jets 2 (optional)

Press **jets 2** once to turn pump 2 on and off and to shift between low and high speeds. If left running, the pump will turn off after 30 minutes. **NOTE:** If the spa does not have two pumps, the **jets 2** button will be labeled **aux**.

Auxiliary Jet(s) Control

An optional auxiliary control pad(s) on the side of the spa can also activate the pump(s).

Option

This button does nothing by itself; however, it is used as part of the Invert sequence described as follows.

Invert Display

Press **warmer** or **cooler + option** to change the direction of the information on the display.

Light

Press **light** to toggle the light on and off. The light will turn off automatically after 4 hours.

LED Light (optional)

Press **light** to toggle the light on and off. Press **light + light** to shift through color options. The light will turn off automatically after 4 hours.

Freeze Protection

If the temperature drops to 44°F (7°C) within the heater, the pump automatically activates to provide freeze protection. The pump will stay on 4 minutes after the sensor has detected the temperature has reached 45°F (7°C) or higher.

Cleanup Cycle (optional)

A cleanup cycle begins 30 minutes after the pump is turned off or times out. The pump and ozone purifier* will run for 1 hour. **NOTE:** To activate this feature, contact your authorized Bullfrog Spa dealer.

Locking the Panel

Press **time + jets 1 + warmer** within 3 seconds. When locked, the Panel Lock (PL) indicator light will light. All buttons will be frozen except the time button. To unlock the panel, press **time + jets 1 + cooler**.

Locking the Set Temperature

Press **warmer** or **cooler + time + jets 1 + warmer** within 3 seconds to activate the lock. The TL indicator light will light when the set temperature is locked. To unlock the set temperature, press **warmer** or **cooler + time + jets 1 + cooler**.

***Ozone Purifier (optional)**

The ozone purifier runs during filter cycles (except when pump 1 is operating on high speed or when pump 2 is running on any speed) and during clean-up cycles.

Diagnostic Message (for all control Systems)

| Message | Meaning | Action Required |
|---------------|---|---|
| | No message on display. Power has been cut off to the spa. | The control panel will be disabled until power returns. Spa settings are preserved until the next power-up. |
| OHH | Overheat - The spa has shut down. One of the sensors has detected that the spa water is 118°F (47.8°C) at the heater. | DO NOT ENTER THE WATER. Remove the spa cover and allow water to cool. Once the heater has cooled, reset by pushing any button. If spa does not reset, shut off the power to the spa and contact your authorized Bullfrog Spa dealer. |
| OHS | Overheat - The spa has shut down. One of the sensors has detected that the spa water is 110°F (43.3°C). | DO NOT ENTER THE WATER. Remove the spa cover and allow water to cool. At 107°F (41.7°C), the spa should automatically reset. If spa does not reset, shut off the power to the spa and contact your authorized Bullfrog Spa dealer. |
| ICE | Ice – Potential freeze conditions detected. | No action is required. The pumps will automatically activate regardless of spa status. |
| SnA | Spa has shutdown. | The sensor plugged into sensor "A" jack is not working. The error may appear temporarily in an overheat situation and disappear once the heater cools. If the problem persists, contact your authorized Bullfrog Spa dealer. |
| SnB | Spa has shutdown. | The sensor plugged into sensor "B" jack is not working. The error may appear temporarily in an overheat situation and disappear once the heater cools. If the problem persists, contact your authorized Bullfrog Spa dealer. |
| SnS | Spa has shutdown. | Sensors are out of balance. If this is alternating with the temperature, it may just be temporary. If the problem persists, contact your authorized Bullfrog Spa dealer. |
| HFL | A difference between the temperature sensors was detected. | This could indicate a flow problem. Check water level in spa. Refill if necessary. If the water level is acceptable, make sure the pumps have been primed. If the problem persists, contact your authorized Bullfrog Spa dealer. |
| LF | Heater is shut down, but other spa functions run normally (displays on the 5 th occurrence of the HFL message within a 24-hour period). | Persistent low flow problems. Follow the instructions for the HFL message. Heating capacity of the spa will not reset automatically. Press any button to reset. |
| dr | Inadequate water detected in heater. | Check water level in spa. Refill if necessary. If the water level is okay, make sure the pumps have been primed. Press any button to reset. |
| dr4 | Spa is shut down (displays on the 3 rd occurrence of the dr message). | Inadequate water detected in the heater. Follow the actions listed for the dr message. The spa will not reset automatically. Press any button to reset. |
| Pr | When your spa is first actuated, it will go into Priming mode. | The Priming mode will last for up to 4 minutes and then the spa will begin to heat and maintain the water temperature in the Standard mode. |
| --F--E | Temperature not yet known. | This is normal within the first few minutes of the spa power up. |
| --- | Temperature not yet known. | This is normal within the first few minutes of the spa power up. |
| bUF | Internal problem detected. | Repair required. Contact your authorized dealer or service organization. |

| Message | Meaning | Action Required |
|---|--|--|
| Std | The spa is operating in Standard mode. | Temperature display is current after pump has been running for at least 2 minutes. Press temp followed by light to switch modes. |
| Ecn | The spa is operating in Economy mode. | Ecn will appear solid on the display when the temperature is not current. Ecn will alternate with the temperature when the temperature is current. Press temp followed by light to switch modes. |
| SE | The spa is operating Standard-in-Economy mode. | Operates the same as Standard mode; however it will revert to Economy mode after 1 hour. Press temp + light to switch directly to Economy mode. |
| SLP | The spa is in Sleep mode. | Press temp + light to switch modes. |
| Sby | The spa is in Standby mode. | Press any button to exit mode and return to normal operation. |
| Periodic Reminder Messages (On Premier Control Panel, press mode/prog to reset a displayed reminder. On Select and Basic Control Panels, press temp + light to reset a displayed reminder.) | | |
| rPH | Every 7 days | Test and adjust chemical levels per manufacturer's instructions. |
| rSA | Every 7 days | Test and adjust chemical levels per manufacturer's instructions. |
| rCL | Every 30 days | Remove, clean, and reinstall filter per manufacturer's instructions. |
| rtS | Every 30 days | Test and reset GFCI per manufacturer's instructions. |
| rdr | Every 90 days | Drain and refill spa per manufacturer's instructions. |
| rCO | Every 180 days | Clean and condition cover per manufacturer's instructions. |
| rtc | Every 180 days | Clean and condition cabinet per manufacturer's instructions. |
| rCH | Every 365 days | Install new filter. |
| <p>⚠ WARNING! SHOCK HAZARD! No User Serviceable Parts. Do not attempt service of this control system. Contact your authorized Bullfrog Spa dealer or service organization for assistance. Follow all power connection instructions listed in this manual. Installation must be performed by a licensed Electrician and all grounding connections must be properly installed.</p> | | |

JetPaks™

Interchanging JetPaks

Step 1: Put the spa in Standby mode, this will prevent the pump(s) from activating (see Control System).



Step 2: Carefully, remove the head rest by lifting upwards.

Step 3: Push the JetPak™ forward until you have enough room to reach the two PVC water unions and air-line union.



Step 4: Loosen the two PVC unions, pull the manifold out from in between the two water unions and remove the JetPak from the JetPod™.



Step 5: Disconnect the air line union.



Step 6: Exchange JetPaks™.

Step 7: Reattach the JetPaks by reversing steps 1-5.

IMPORTANT: Spa models with two pumps have two different JetZones™. These JetZones are divided by a JetZone Divider™. Never operate the spa without the JetZone divider in place. Doing so will cause serious damage to the pumps. In addition, interchanging JetPaks™ from one JetZone to another may result in improper water flow to one or more JetPaks. Do not install the JetZone Divider in either the first or the last seat. If you have questions or problems, see the *JetZones* section or contact your authorized Bullfrog Spa dealer.

NOTE: The NeckBlaster™ JetPak (J4) will only fit in the Lounger or Recliner (corner seats). Due to its large amounts of plumbing and jets, the NeckBlaster will not fit in a Bucket (middle or wall seat).

Jetting

Jet Types

Depending on the design, your spa comes with a unique combination of the following jets:

| | |
|---|--|
|  | Neck Adjustable: Yes |
|  | Cluster Storm Adjustable: Yes |
|  | Shower Adjustable: No |
|  | Duo Adjustable: No Interchangeable with Duo-Blaster |
|  | Duo-Blaster Adjustable: No Interchangeable with Duo |
|  | Micro VSR Adjustable: Yes |
|  | Storm Roto Adjustable: Yes Interchangeable with Storm Massage |
|  | Storm Massage Adjustable: Yes Interchangeable with Storm Roto |

| | |
|---|---------------------------------------|
|  | Verta'ssage Adjustable: No |
|  | Handheld Adjustable: No |
|  | Jumbo Storm Adjustable: Yes |
|  | Whirlpool Adjustable: Yes |

Interchangeable Jets

Certain jets allow for interchangeable jet nozzles. Always contact your authorized Bullfrog Spa dealer before attempting to modify the jetting on your spa.

Adjustable Jets

To adjust the water pressure on the jets, simply turn the outer ring.

- To increase jet water pressure, turn the outer ring clockwise
- To decrease jet water pressure, turn the outer ring counter clockwise

NOTE: Never shut all the jets off at the same time.

JetZones™

Spas powered by two pumps provide a unique feature called JetZones. A JetZone™ is a region of jets powered by the same pump. With JetZones, you decide which JetPaks™ are powered by each pump. Two-pump spas have two JetZones.

Each pump (on two-pump models only) provides water flow to its own JetZone. Each JetZone can be customized with the use of a JetZone Divider™ (included).

By simply moving the JetZone Divider, you can increase or decrease the number of JetPaks that are powered by a particular pump, thus creating a new JetZone. By adding JetPaks to a particular JetZone, you will decrease the power to that zone. By removing JetPaks from a particular zone, you will increase the power to that zone. To Create a New JetZone:

Step 1: Remove the JetPaks by following steps 1-5 in *Interchanging JetPaks* of the *JetPak* section.

Step 2: Loosen the two PVC unions, pull the manifold out from the two water unions and remove the JetPak from the JetPod™.

Step 3: Remove the JetZone Divider and reinstall the divider in a location of your choice (never install in either the first or the last seat).

Step 4: Reattach the JetPaks by reversing the JetPak removal procedure.



⚠WARNING: Never operate the spa without the JetZone Divider in place or by installing the JetZone Divider in the first or the last seat. Doing so may cause serious damage to the pumps.

Maintenance

Water Chemistry

Tap water that is safe to drink is not always safe for a spa. Normal tap water is usually filled with minerals and micro-contaminants that are not visible to the naked eye. Properly testing and treating your spa water is essential for the health of the spa as well as the people using it. Proper chemical maintenance will help control and prevent the following:

- Bacteria, algae, and fungi, which can spread disease and infection to humans
- Staining and scale build-up on the spa shell, equipment, and piping
- Clogged filters

⚠CAUTION: Important Instructions. Always:

- Follow chemical manufacturers' instructions
- Use an accurate test kit to perform all chemical tests
- Never mix chemicals
- Add chemicals directly to the spa, evenly spreading the chemicals over the surface of the water or use an appropriate feeding or metering device
- Run the filter pump on high speed for at least 15 minutes after applying chemicals
- Check chemical levels often
- Note that names of spa chemicals will vary from one manufacturer to another
- Contact your authorized Bullfrog Spa dealer with questions

Overview of Water Chemistry

Water Quality Maintenance

Maintaining the quality of the spa water within specified limits will enhance your enjoyment of the spa and prolong the life of its equipment. It is a fairly simple task, but it requires regular maintaining because the water chemistry involved is a balance of several factors. There is no simple formula and there is no avoiding it. A careless attitude regarding water maintenance will result in poor and potentially unhealthful conditions for bathing and possible damage to your spa. For specific guidance on maintaining water quality, consult your authorized Bullfrog Spa dealer who can recommend appropriate chemical products for sanitizing and maintaining your spa.

Sanitation

Sanitizers kill bacteria and viruses and keep the water clean. A low sanitizer level will allow bacteria and viruses to grow quickly in the spa water. To raise the sanitizer level, simply add an approved sanitizer. A high sanitizer level can cause discomfort to eyes, lungs and skin. To lower the sanitizer level,

simply wait – the sanitizer level will naturally drop over time. Effective and safe sanitizers include Granular Chlorine (Dichlor-type only) and Granular Bromine.

NOTE: Increased use of the spa (or in the number of users of the spa) will result in the need to increase the amount of sanitizer required to maintain the recommended sanitizer level.

NOTE: Ozone purification is recommended only as a supplement to the above sanitizers. The Bullfrog WellSpring™ Ozone Purifiers greatly enhance the quality of the spa water when used in conjunction with an industry standard spa chemical maintenance program.

⚠CAUTION: Never use ozone as a single-source sanitizer, water clarifier, stain & scale inhibitor or foam inhibitor.

⚠WARNING: Trichlor Chlorine tablets should never be used in a portable spa. Dissolve rate, potency and the extreme low pH of this chemical can cause severe damage to the spa surface and components. Use of Trichlor Chlorine tablets will void the warranty.

⚠WARNING: Bromine and Dichlor tablets are also not recommended as an acceptable sanitizer in a Bullfrog Spa or Tadpole Hot Tub unless in an appropriate feeding or metering device. Inconsistency in its application and excessive Bromine or Chlorine in the spa can cause surface damage and component failure. Use of either of these sanitizer tablets in any automatic "floating-type" tablet feeder will require more frequent monitoring and testing. Misuse of Bromine or Dichlor tablets will void the warranty.

⚠WARNING: Products containing Baguanide (Baqua) are also not recommended for use in your spa. These products are known to deteriorate light lenses, pump seals and other spa components. Misuse of Baquanide products will void the warranty.

Super Sanitation

Normal sanitation does not eliminate Chloramines (trapped Chlorine), Bromamines (trapped Bromine), along with other non-filterable wastes, such as perspiration, oils, hair sprays, etc. that can build up in the water. These substances make the water unattractive in appearance and odor, and can interfere with sanitizer effectiveness. Super Sanitizing (or "shocking" or "Super Chlorinating") the spa water is achieved when the sanitizer level reaches or exceeds 10.0 PPM with granular Chlorine (Dichlor), or 22.0 PPM with granular Bromine (Bromine concentrate). Super Sanitation can also be achieved with a non-Chlorine shock (Potassium

Peroxymonosulfate or equivalent). Contact your authorized Bullfrog Spa dealer for assistance.

When Super Sanitizing your spa water, and providing that you are available to attend to the safety of any children present, you should allow the high level of sanitizer to off-gas by opening the spa cover at least half way for a minimum of 20 minutes. Failure to allow high concentrations of sanitizer to off-gas with the spa cover open will cause the underneath side of the cover to discolor and degrade. Such damage to the spa cover is not covered under the terms of your spa's warranty.

⚠️WARNING: Never leave an open spa unattended, especially if there are children present.

IMPORTANT: Always allow the chlorine level to fall below 5.0 PPM (11.0 with Bromine) before entering the spa water.

pH Control

Proper pH balance is extremely important in providing water that is comfortable to the user, and preventing damage to the spa and equipment. The measure of acidity and basicity in the water is called pH. The pH scale ranges from 0-14. Levels of pH less than 7.0 are acidic while pH levels greater than 7.0 are basic. The proper pH range for a spa is 7.4-7.6.

High pH levels (greater than 7.6) can cause scale build-up on the spa and its equipment, cloudy water, a prematurely dirty filter, and less effective sanitation. To correct high pH levels, add a pH decreaser.

Low pH levels (less than 7.4): can cause discomfort to the spa users, rapid dissipation of sanitizer, and corrosion to the spa equipment. To increase pH levels, add a pH increaser.

NOTE: Never use Muriatic or Hydrochloric acid to adjust pH as it can damage the spa shell and surrounding components.

Total Alkalinity (TA)

TA is the quantitative measurement of alkaline components (carbonates and bicarbonates) present in water, which if properly adjusted, act as a buffer against rapid pH changes. Proper total alkalinity levels are important to ensure optimal chemical balance in spas. Low TA can cause the pH to be unstable causing the water to be corrosive or scale forming to the spa and its equipment. To correct low TA, add a Total Alkalinity Increaser. High TA can cause scale build-up, cloudy water, as well as other pH problems. If the spa water has high TA, contact your authorized Bullfrog Spa dealer for assistance.

Calcium Hardness (CH)

CH is the measure of dissolved calcium in the water. Low CH (soft water) can stain the spa surface as well as cause corrosion to the spa and its equipment. To correct low CH, add a CH Increaser. High CH (hard water) can cause cloudy water as well as rough scale build-up on the spa surface and equipment. If the spa water has high CH, it is preferable to either dilute the water's hardness by blending the water with water from a water softener, or by the addition of a special water softening chemical (contact your authorized Bullfrog Spa dealer). **IMPORTANT:** Never fill the entire spa with soft water unless an appropriate mineral supplement is immediately added (contact your authorized Bullfrog Spa dealer).

Stain and Scale Control

Stain and scale problems are common in hot water environments. To help prevent and control staining and scaling, add a Stain and Scale Inhibitor.

Foam Control

Spa water that is polluted with body oils and lotions, combined with high water temperatures, can cause excessive surface foaming. For a temporary fix, add a Foam Remover. The best way to control foam is to Super Sanitize the water; this will destroy the soap agents that normal levels of sanitizer will not.

Cloudy Water Prevention and Control

There are two basic reasons that spa water becomes cloudy. Non-filterable liquid waste (e.g. perspiration) have contaminated the water. To remove these substances, Super Sanitize the water. Or, non-filterable micro-particulate waste (e.g. dust) has contaminated the water. To remove these substances use a Water Clarifier.

Starting the Spa with New Water

IMPORTANT: Never fill the spa with soft water unless an appropriate mineral supplement is immediately added. If your water is extremely hard, it is preferable to either dilute the water's hardness by blending the water with water from a water softener, or by the addition of a special water softening chemical. For more information, contact your authorized Bullfrog Spa dealer.

Step 1: Add the prescribed dose of Stain and Scale Inhibitor while filling the spa. This will provide the initial protection against staining and scaling. Once the spa is filled, add the prescribed dose of Water Clarifier. This will clear the water of any micro-particulates that may be in the new water.

Step 2: If possible, have your authorized Bullfrog Spa dealer test the calcium hardness (CH) of your spa water. Adjust the CH to 150-200 parts per million (PPM).

Step 3: Test and adjust the Total Alkalinity (TA). TA should measure 125 to 150 PPM.

Step 4: Test and adjust the pH. Water pH should measure 7.4 to 7.6.

Step 5: After the spa water has circulated for 1 hour, Super Sanitize the water by adding 2 teaspoons (10cc) of Granular Chlorine (Dichlor-type only) or 4 teaspoons (20cc) of Granular Bromine per 200 gallons (909.2l) of spa water. (For complete details, refer to the *Super Sanitation* section.) After several hours, check sanitizer level and adjust, if necessary, to the following:

| | Without Ozone | With Ozone |
|----------------|---------------|--------------|
| Chlorine Level | 3.0-5.0 PPM* | 2.0-4.0 PPM |
| Bromine Level | 6.7-11.0 PPM | 5.7-10.0 PPM |

*PPM=Parts per million

IMPORTANT: Do not enter the spa water until the sanitizer range is within the above stated boundaries. **NOTE:** If the sanitizer level is too high, simply wait as the sanitizer level will naturally drop over time.

Step 6: Startup water chemistry is now complete. However, it may take several days for the filter to completely clear the water.

Maintaining Spa Water Sanitizer and pH Levels

It is important to test and adjust the sanitizer and pH levels of your spa on a frequent basis. These tests should be performed prior to each use of the spa. At a minimum, it is recommended that you test the spa water 2-3 times a week, regardless of use.

Always test the pH level before you test the sanitizer level. If the pH level is not within the correct range (7.4-7.6), make the necessary adjustments.

With each sanitizer test, use either granular Chlorine (Dichlor-type only) or granular Bromine to maintain the following levels:

| | Without Ozone | With Ozone |
|----------------|---------------|--------------|
| Chlorine Level | 3.0-5.0 PPM | 2.0-4.0 PPM |
| Bromine Level | 6.7-11.0 PPM | 5.7-10.0 PPM |

IMPORTANT: To maintain the level of sanitizer with Bromine or Chlorine (Dichlor-type only) tablets, contact your authorized Bullfrog Spa dealer for assistance.

Super Sanitation

Super Sanitize the water once a week by adding one of the following:

- 2 teaspoons (10cc) of granular Chlorine per 200 gallons (909.2l) of water
- 4 teaspoons (20cc) of granular Bromine per 200 gallons (909.2l) of water

NOTE: To Super Sanitize your spa water using a non-chlorine shock (Potassium Peroxymonosulfate or equivalent) refer to the chemical manufacturer's instructions or see your authorized Bullfrog Spa dealer for assistance.

NOTE: Super sanitation may be required more than once per week for heavy usage.

Stain and Scale Control

Use a Stain and Scale Inhibitor per the manufacturer's instructions. Add the chemical 3-4 days after Super Sanitation.

Foam Control

Use a Foam Remover per the manufacturer's instructions as needed.

Cloudy Water Prevention and Control

Use a Water Clarifier per the manufacturer's instructions. Add the chemical 3-4 days after Super Sanitation.

Water Chemistry Troubleshooting

Prior to each spa use, check the water. If the water appears cloudy or off-color, has significant surface foam, or excessively smells of chlorine or bromine, than water needs to be treated or drained. Using the spa in these conditions could result in a skin rash or irritation or possibly an infection or other serious health risk. For assistance in handling spa water chemistry, contact your authorized Bullfrog Spa dealer or another service center capable of performing a computerized water analysis.

Changing Spa Water

As you use your spa, soap and detergent residues from your skin and bathing suits, along with other substances from maintaining the spa's water chemistry will accumulate in the spa water and make maintaining the water more difficult. Rinsing your bathing suits, and showering without soap, prior to entering your spa will increase the life of your spa water. Depending upon usage, the spa water will need to be changed every 1-4 months or when the water chemical levels become difficult to manage. When changing spa water, remove all JetPaks™. Clean the JetPod™ areas with a spa surface cleaner. See *Spa Shell Care*. Clean the plumbing areas on the back of the JetPaks with a spa surface cleaner and a long, soft bristle brush.

IMPORTANT: Drain your spa to an area that can handle a large quantity of water. If draining water onto vegetation, make sure that the sanitizer level (Chlorine or Bromine level) of the water is less than 0.5 PPM.

⚠ WARNING: Avoid drainage that can lead into basement window wells.

To Drain Your Spa:

Step 1: Disconnect electrical power supply.

Step 2: Remove equipment compartment door.

Step 3: Locate the drain hose.

Step 4: Lift the drain hose higher than the water level in the spa.

Step 5: Remove drain hose cap.

Step 6: Connect a garden hose to the drain hose.

Step 7: Lower to ground level and drain.

NOTE: For faster draining, you can purchase a PowerDrain™ from your authorized Bullfrog Spa dealer. For steps to drain the spa using the PowerDrain, please see the PowerDrain product usage instructions that are included with this accessory.

To Refill Your Spa:

⚠ WARNING: When refilling the spa, always Super Sanitize the new water by adhering to the instructions in the *Water Chemistry* section.

Step 1: Remove garden hose from drain hose.

Step 2: Replace drain hose cap.

Step 3: To avoid air pockets in the pump(s), refill the spa with water by placing the hose into the filter compartment through the Weir door. Fill to the water level indication on the faceplate of the filter assembly.

Step 4: Restore electrical power supply.

Step 5: Press any button to reset the control system.

Step 6: Reattach the equipment compartment door.

Step 7: Following instructions in *Starting the Spa with New Water*.

IMPORTANT: Never fill the spa with soft water unless an appropriate mineral supplement is immediately added. If your water is extremely hard, it is preferable to either dilute the water's hardness by blending the water with water from a water softener, or by the addition of a special water softening chemical. For more information, see your authorized Bullfrog Spa dealer.

NOTE: The higher the water level in the spa, the fewer spa users it will be able to handle.



Filter Cleaning

It is recommended that the filter cartridge(s) be cleaned every 3-6 weeks or as needed. Replace the filter cartridge(s) every 1-2 years or when necessary. To maintain warranty protection, use only genuine Bullfrog Filter Cartridge replacements. To clean your filter cartridge(s), complete the following:

Step 1: Place the spa in Standby mode.

Step 2: Remove FilterCap™.

Step 3: Remove cartridge(s).

Step 4: Using a garden hose with a nozzle or other high-pressure device, clean cartridge(s). Work top to bottom on each pleat.

- To remove collected suntan lotions or body oils, soak cartridge(s) in warm water with a Filter Cleaner or detergent.
- To remove calcium deposits, soak cartridge(s) in a plastic container using a 1:10 ratio of Muriatic acid to water solution. Calcium deposits indicate a high spa pH, which should be corrected.

Step 5: Reinstall cartridge(s) and FilterCap.

Step 6: Press any button to reset the control system.

To ease the burden of cleaning a filter cartridge, consider Bullfrog's SpinClean™ filter cleaning device (see *JetPaks and Accessories* or contact your authorized Bullfrog Spa dealer).

IMPORTANT: Using a brush to clean a filter cartridge could cause damage to the cartridge.



Light Bulb and LED Replacement



To replace a burned out or defective light bulb or LED, complete the following:

Step 1: Turn off the electrical power at the breaker box.

Step 2: Remove the equipment compartment door.

Step 3: Locate the back of the light fixture.

For standard light bulb replacement:

Step 4: Grasp the light bulb holder (located on the back of the light fixture) and twist counter-clockwise to release the light from the fixture.

Step 5: Remove the light bulb by pulling it straight out of the light bulb holder.

Step 6: Replace the light bulb and reinstall the light bulb holder.

For LED replacement:

Step 4: Insert a small standard screwdriver into the tabbed slot (see arrow).

Step 5: Carefully pry off the back light fixture cover.

Step 6: Remove the LED assembly by pulling it straight out. Replace the LED. Reinstall the back cover of light fixture.

For both lighting systems:

Step 7: Replace the equipment compartment door.

Step 8: Restore the electrical power supply.

NOTE: For alternate lighting systems, contact your authorized Bullfrog Spa dealer.

Ozone Purifier Replacement

On the front of the Ozone Purifier (optional) is the indicator light. To verify that the Ozone Purifier is working properly, check to ensure that the indicator light is glowing while the filter pump is running during a period when the pump has been activated automatically.

IMPORTANT: The indicator light will not be on when any jets button has been activated manually. The light will remain off for 30 minutes thereafter.

NOTE: If the indicator light does not turn on during automatic filter pump operation, contact your authorized Bullfrog Spa dealer for service.



High-Output Ozone Purifier

Spa Shell Care

General Cleaning

For normal cleaning, use a mild dishwashing soap such as Ivory® liquid or a window cleaner such as Windex®. For stubborn stains, use a mild liquid cleaner such as Softscrub® or a mild detergent such as Spic And Span®. To apply these cleaners, use a soft, damp cloth or sponge. Rinse well and dry with a clean cloth. To clean hard water stains, remove light scratches and protect your spa shell, contact your authorized Bullfrog Spa dealer.

Cleaning the Scum Line

With normal use of the spa, oils, lotions, and hairspray will build up on the surface of the water. This will leave a scum line around the perimeter. This can be easily removed using a spa surface cleaner or its equivalent. Avoid using cleaning agents that leave suds in the water.

⚠ WARNING: Never allow your spa surface to be exposed to alcohol, acetone (nail polish remover), nail polish, drycleaning solution, lacquer thinners, gasoline, pine oil, abrasive cleaners, or any other household chemicals other than those listed. These chemicals can void the warranty.

JetPak™ Plumbing Care

At least twice a year, or every time spa water is changed, remove all JetPaks. Clean the plumbing on the back of the JetPaks with a spa surface cleaner and a long, soft bristle brush. For cleaning the JetPak acrylic surface, refer to *Spa Shell Care*.

Spa Cabinet Care

The EternaWood™ cabinet components are made to provide many years of maintenance-free service. For normal cleaning, use a mild dishwashing soap. For stubborn stains, contact your authorized Bullfrog Spa dealer.

Spa Cover Care

Your spa cover is warranted by its manufacturer, Sunstar Enterprises, 255 Redel Road, San Marcos, CA 92078 (800) 438-8677. Although basic instructions are provided below, it is important that you refer to the Sunstar information that came with the cover. Sunstar provides detailed information on caring for your spa cover and what to do to protect its warranty.

⚠ WARNING: A non-secured or improperly secured cover may pose a safety threat to children and may also cause damage or injury if blown off by wind. Always remove entire cover before using the spa.

IMPORTANT: Do not stand, sit, or place any item on the cover that could damage it. Gently remove any snow accumulations over 2" (5.08cm). Do not use any cleaners other than those recommended by Sunstar Enterprises. Always secure the cover with all of the cover locks when not in use, whether the spa is empty or full of water. When Super Sanitizing your spa, always follow the cover care instructions provided in the *Super Sanitation* section.

Cleaning the Spa Cover

At least monthly, clean the spa cover.

Step 1: Remove the cover and lay it down on a flat, clean surface near a garden hose.

Step 2: Rinse the cover to remove any loose debris.

Step 3: Clean the top (vinyl) of the cover with a mild solution of dishwashing soap and a soft bristle brush. Using a gentle circular motion, scrub the cover, careful to not let any of the cover dry before rinsing with water.

Step 4: Rinse the cover thoroughly and dry with a clean cloth.

Step 5: Use saddle soap (never a petroleum-based product) to condition the cover per the manufacturer's instructions.

Step 6: Wipe and rinse any dirt from the bottom of the cover.

Step 7: Replace the cover and secure the locks.

NOTE: To remove tree sap, use lighter fluid (the type used in cigarette lighters). Use sparingly. Immediately, apply saddle soap to the area.

Miscellaneous Care

Cleaning and Protecting the Headrests

Regularly, clean all headrests with mild soap, water, and a clean cloth. Monthly, use a non-petroleum-based product such as 303 Aerospace Protectant manufactured by 303 Products, Inc. This will maintain water resistance and luster of the product. **NOTE:** Headrest discoloration is caused by improper water chemistry and is not covered under the Bullfrog or Tadpole warranty.

Vacuum the Spa

Debris from wind, trees, and users will occasionally accumulate on the bottom of the spa. The filtration system will remove the smaller debris; however, debris that is too large or heavy will have to be removed by a spa vacuum. If you do not have a spa vacuum, contact your authorized Bullfrog Spa dealer.

Freeze Prevention

In regions where low temperatures fall below 5°F (-15°C), it is recommended that a 2" (5.08cm) insulation board or blanket be secured to the backside of the spa equipment compartment door. **IMPORTANT:** When daytime outside temperatures reach 60°F (15.6°C), the equipment compartment insulation must be removed to prevent overheating of the equipment.

Low-Use or No-Use Periods

During certain times of the year, you may not use the spa on a frequent basis. For these low-use or no-use periods, consider the following:

Low Use or No Use for less than Two Weeks

Do not make any changes.

No Use for Two to Six Weeks

If the spa will not be used for at least two weeks, lower the temperature to the lowest setting of 80°F (26°C) or place in Sleep Mode. Lowering the temperature will cut the cost of operation, however; you will need to adjust the temperature setting approximately 4 hours before use in order to heat the spa to 100°F (38°C).

IMPORTANT: During all low- and no-use periods, be sure to maintain the spa water as per the instructions in the *Water Chemistry* section.

IMPORTANT: For all no-use periods, and on a weekly basis, be sure to have someone visually check that the spa is functioning correctly and to also maintain the spa water as per the instructions under the *Water Chemistry* section. Not doing so may lead to corrosion, staining, and/or scaling to the spa and its equipment. During periods of freezing temperatures, a spa that has malfunctioned may be subject to damaged plumbing or equipment as a result of ice buildup within the spa. If the spa cannot be checked and maintained on a weekly basis, then consider winterization.

Winterization (No use for over six weeks)

When you are not planning to use the spa for six or more weeks, or when someone is not able to maintain the spa on a weekly basis, you should winterize the spa. To winterize, follow these steps:

⚠WARNING: Prior to winterizing your spa, it will be necessary to Super Sanitize the spa water as per the instructions in the *Water Chemistry* section. This procedure will help prevent the growth of bacteria, algae and fungi in any areas of plumbing that may not be fully free of water after you drain your spa for its period of winterization.

Step 1: Drain the water.

Step 2: Remove the drain plug from the pump(s), loosen all PVC pipe unions, and pump air-bleed valves in the equipment compartment. Do not replace the plugs, tighten the unions or close the air-bleed valves until the spa is de-winterized.

Step 3: Clean the entire spa.

Step 4: Remove filter cartridge(s) and clean. Allow filter to dry fully and store in a dry place.

Step 5: Secure the cover to the spa utilizing the tie downs and locking system. In areas where heavy snow is anticipated, place a large piece of plywood (or its equivalent) on top of the spa cover to assist in supporting the cover with the added weight of the snow. Remove snow off the cover following each snow storm.

⚠WARNING: To avoid water from becoming trapped between the floor suction fitting and the filter pipe close the slice valve in front of the pump leading to the filter. Use a wet/dry vacuum to remove the remaining water out of pipe by placing the vacuum end over the filter hole. In a two-pump spa, first plug off one filter then vacuum out the water. Or pour 1-2 gallons (4.55-9.09l) of RV antifreeze into the filter hole. **NOTE:** RV antifreeze is nontoxic and does not require evacuation at start up.

Spa De-Winterization

To de-winterize the spa, reverse the Winterization procedure. Refill to the water level mark.

⚠WARNING: Whenever refilling the spa, it will be necessary to Super Sanitize the new spa water. Instructions are found in the *Water Chemistry* section.

Service

Before requesting service from your dealer, refer to the *Troubleshooting* section to determine the necessary course of action. If the problem cannot be solved using the *Troubleshooting Guide*, contact your authorized Bullfrog Spa dealer.

Warranty Service

If the spa falls within the warranty period and within the scope of the warranty, contact your authorized Bullfrog Spa dealer to schedule a service call. You will be required to show proof of purchase. **NOTE:** Damage caused by repairs made by someone other than an authorized Bullfrog Spa technician will void the spa's warranty.

Non-Warranty Service

An authorized Bullfrog Spa technician should perform all repairs that fall outside of the warranty coverage or beyond the warranty period. If you are not able to use an authorized technician, you should use genuine Bullfrog replacement parts.



BullfrogTM
INTERNATIONAL_{LC}

668 West 14600 South • Bluffdale, Utah 84065, USA
801.565.8111 • Fax: 801.565.8333

www.bullfrogspas.com
info@bullfrogspas.com

Troubleshooting Guide

This guide will assist in solving simple problems with the spa. If the problem cannot be solved using these procedures, contact your authorized Bullfrog Spa dealer.

Control panel displays an error message:

Cause: An error has occurred.

Solution: See **Diagnostic Messages** for specific errors.

Control pad and spa equipment do not operate:

Cause #1: No electrical power to spa.

Solution: Turn on or reset the GFCI circuit breaker. If this does not solve the problem, have a qualified Electrician check the electrical service.

Cause #2: The 20 or 30A fuse, depending on the system, has blown.

Solution: Contact your authorized Bullfrog Spa dealer.

GFCI breaker trips repeatedly:

Cause #1: Improper wiring to spa or GFCI breaker is defective.

Solution: Consult with a qualified Electrician.

Cause #2: There is a defective component on the spa.

Solution: Contact your authorized Bullfrog Spa dealer.

Spa pump turns off during operation:

Cause #1: Automatic timer has completed its 30 or 120 minute cycle.

Solution: Turn on the pump.

Cause #2: Pump has overheated due to the vents on the equipment door being blocked.

Solution: Clear items away from vents.

Cause #3: The pump motor is defective.

Solution: Contact your authorized Bullfrog Spa dealer.

Spa will not heat:

Cause #1: Slice valve is partially or fully closed.

Solution: Open slice valve and secure with valve keeper.

Cause #2: Thermostat has been turned down.

Solution: Adjust thermostat to desired temperature.

Cause #3: High limit sensor has tripped.

Solution: Press any button to reset.

Cause #4: Heating system is defective.

Solution: Contact your authorized Bullfrog Spa dealer.

Spa light does not work:

Cause #1: Light bulb has burned out.

Solution: Replace light bulb.

Cause #2: Lighting system is defective.

Solution: Contact your authorized Bullfrog Spa dealer.

Spa pump will not turn on, creates a burning smell while running, or makes excessive noise while running:

Cause: Pump motor is defective.

Solution: Contact your authorized Bullfrog Spa dealer.

Jets surge on and off:

Cause: Water level is too low.

Solution: Adjust water to the water level indication mark on the faceplate of the filter assembly.

Jets are weaker than normal or do not work at all, but the pump is running:

Cause #1: Jet handle(s) are partially or fully closed.

Solution: Open jet handle(s).

Cause #2: Filter cartridge is dirty.

Solution: See *Cleaning the Filter*.

Cause #3: There is air trapped in the spa equipment or its face piping.

Solution: Open the air bleed valve on each pump's housing and allow air to bleed out of the system. Be sure to tighten each air bleed valve as soon as water starts to flow.

Cause #4: The suction fitting(s) are blocked.

Solution: Remove any debris that may be blocking the suction fitting(s).

Cause #5: The JetZone Divider™ is not installed (if applicable).

Solution: Re-install in the appropriate JetPak™.

NOTE: Running the spa without a JetZone Divider can cause serious damage to the pumps.

Cause #6: Slice valve is closed.

Solution: Open valve and secure with valve keeper.

Miscellaneous

Bullfrog Custom Portable Spas Technical Specifications

| General Features | Model 331 | Model 451 | Model 562 | Model 552 | Model 662 | Model 682 |
|--|--|--|---|---|---|---|
| Standard Dimensions (W x L x H) | 5'-6" x 6'-10" x 31" | 6'-7" x 7'-4" x 35" | 7'-4" x 7'-4" x 35" | 7'-10" x 7'-10" x 35" | 7'-10" x 7'-10" x 35" | 7'-10" x 7'-10" x 35" |
| Metric Dimensions (W x L x H) | 1.73m x 2.09m x .79m | 2.01m x 2.24m x .89m | 2.24m x 2.24m x .89m | 2.39m x 2.39m x .89m | 2.39m x 2.39m x .89m | 2.39m x 2.39m x .89m |
| Seating Capacity | 3 | 5 | 6 | 5 | 6 | 8 |
| Bucket Seats | 2 | 2 | 3 | 2 | 3 | 3 |
| Recliner Seats | 0 | 1 | 2 | 1 | 2 | 3 |
| Lounger Seats | 1 | 1 | 1 | 2 | 1 | 0 |
| Cool Down Seats | 0 | 1 | 0 | 0 | 0 | 2 |
| Water Capacity | 205 Gallons (776 Liters) | 304 Gallons (1151 Liters) | 360 Gallons (1363 Liters) | 411 Gallons (1556 Liters) | 416 Gallons (1575 Liters) | 425 Gallons (1609 Liters) |
| Dry/Maximum Filled Weight (includes cover) | 563lbs./2898lbs. (255kg/1315kg) | 663lbs./4024lbs. (301kg/1825kg) | 815lbs./4685lbs. (370kg/2125kg) | 894lbs./5406lbs. (406kg/2452kg) | 894lbs./5473lbs. (406kg/2482kg) | 894lbs./5564lbs. (406kg/2524kg) |
| Full-Foam Insulation/PolyBase Sealed Bottom | Standard | Standard | Standard | Standard | Standard | Standard |
| EternaWood™ Cabinet Finish (All Colors) | Standard | Standard | Standard | Standard | Standard | Standard |
| High-Performance Industrial 56-Frame Pumps | One Dual-Speed | One Dual-Speed | Two Dual-Speed | Two Dual-Speed | Two Dual-Speed | Two Dual-Speed |
| Total Pump Brake Horsepower | Upgradeable to 4.88HP | Upgradeable to 4.88HP | Upgradeable to 9.68HP | Upgradeable to 9.68HP | Upgradeable to 9.68HP | Upgradeable to 9.68HP |
| Total Pump Continuous-Duty Horsepower | Upgradeable to 2.5HP | Upgradeable to 2.5HP | Upgradeable to 5.0HP | Upgradeable to 5.0HP | Upgradeable to 5.0HP | Upgradeable to 5.0HP |
| Max. Range of Total "Actual" Pump Flow | 229gpm @ 10psi to 137gpm @ 16psi (1041.06lpm @ 69kPa) to 622.82lpm @ 110.4kPa) | 229gpm @ 10psi to 137gpm @ 16psi (1041.06lpm @ 69kPa) to 622.82lpm @ 110.4kPa) | 459gpm @ 10psi to 275gpm @ 16psi (2086.66lpm @ 69kPa) to 1250.18lpm @ 110.4kPa) | 459gpm @ 10psi to 275gpm @ 16psi (2086.66lpm @ 69kPa) to 1250.18lpm @ 110.4kPa) | 459gpm @ 10psi to 275gpm @ 16psi (2086.66lpm @ 69kPa) to 1250.18lpm @ 110.4kPa) | 459gpm @ 10psi to 275gpm @ 16psi (2086.66lpm @ 69kPa) to 1250.18lpm @ 110.4kPa) |
| Freeze Protection | Standard | Standard | Standard | Standard | Standard | Standard |
| Stereo/CD/Spaside Control/Base® Speakers | Not Available | Optional | Optional | Optional | Optional | Optional |
| Corona Discharge Ozone Purifier | Optional | Optional | Optional | Optional | Optional | Optional |
| HO Corona Discharge Ozone Purifier | Optional | Optional | Optional | Optional | Optional | Optional |
| Underwater Light | Large | Large | Large | Large | Large | Large |
| 24-Bulb LED Lighting System | Optional | Optional | Optional | Optional | Optional | Optional |
| Filter Element (Top Accessible) | 50 sq. ft. (4.65 sq. m) | 50 sq. ft. (4.65 sq. m) | 100 sq. ft. (9.29 sq. m) | 100 sq. ft. (9.29 sq. m) | 100 sq. ft. (9.29 sq. m) | 100 sq. ft. (9.29 sq. m) |
| Floor Drain (In Footwell of Spa) | Standard | Standard | Standard | Standard | Standard | Standard |
| JetPaks/Headrests | 3 | 4 | 5 | 5 | 6 | 6 |
| Self-Draining JetPak Feed Lines | Standard w/ Modification | Standard w/ Modification | Standard w/ Modification | Standard w/ Modification | Standard w/ Modification | Standard w/ Modification |
| Automatic Filtration in JetPods | Standard | Standard | Standard | Standard | Standard | Standard |
| Ozone Jet | 1 | 1 | 1 | 1 | 1 | 1 |
| Foot & Leg Jets | 6 | 5 | 6 | 10 | 8 | 4 |
| Maximum Jets Available | 43 | 41 | 69 | 73 | 73 | 77 |
| Maximum Jets Available (With Shower Jets) | 244 | 260 | 463 | 430 | 458 | 503 |
| Control System | Model 331 | Model 451 | Model 562 | Model 552 | Model 662 | Model 682 |
| Balboa EL Control Box w/ "M7" Technology | Programmable/Digital | Programmable/Digital | Programmable/Digital | Programmable/Digital | Programmable/Digital | Programmable/Digital |
| Electrical Requirements | 120V~-20A or 240V~-30/50A | 120V~-20A or 240V~-30/50A | 240V~-30/50A | 240V~-30/50A | 240V~-30/50A | 240V~-30/50A |
| Heater (dual overheat protection) | 1.4KW/5.5KW | 1.4KW/5.5KW | 5.5KW | 5.5KW | 5.5KW | 5.5KW |
| "Select" LCD Master Control Pad: Medium Sized, 4-Button, Partially Backlit & Piezo-Switched features. | Optional | Optional | Optional | Optional | Optional | Optional |
| "Premier" LCD Master Control Pad: Large Sized, 8-Button, Fully Backlit, Clock, Invert, Lock & Piezo-Switched features. | Optional | Optional | Optional | Optional | Optional | Optional |
| Auxiliary Control Pad(s) | Optional (One) | Optional (One) | Optional (Set of Two) | Optional (Set of Two) | Optional (Set of Two) | Optional (Set of Two) |

NOTE: 120V~ Pump Option on 331/451 model is only available in the 48-Frame version.

*Dry/Maximum Filled Weight data includes spa cover but no occupants.

Tadpole Portable Hot Tubs Technical Specifications

| General Features | Model 251 | Model 362 |
|--|--|--|
| Standard Dimensions (W x L x H) | 6'-7" x 7'-4" x 35" | 7'-4" x 7'-4" x 35" |
| Metric Dimensions (W x L x H) | 2.01m x 2.24m x .89m | 2.24m x 2.24m x .89m |
| Seating Capacity | 5 | 6 |
| Bucket Seats | 2 | 3 |
| Recliner Seats | 1 | 2 |
| Lounger Seats | 1 | 1 |
| Cool Down Seats | 1 | 0 |
| Water Capacity | 265 Gallons (1003L) | 321 Gallons (1215L) |
| *Dry/Maximum Filled Weight (includes cover) | 603lbs./3588lbs. (273kg/1628kg) | 772lbs./4266lbs. (350kg/1935kg) |
| Full-Foam Insulation/PolyBase Sealed Bottom | Standard | Standard |
| EternaWood Cabinet Finishes | Redwood Standard (Optional Coastal) | Redwood Standard (Optional Coastal) |
| High-Performance Pumps | One 3.0BHP/120V- Dual-Speed (48-Frame) | Two 3.0BHP/240V- Dual-Speed (56-Frame) |
| Total Pump Horsepower | 3.0 Brake HP (1.5 Continuous-Duty HP) | 6.0 Brake HP (3.0 Continuous-Duty HP) |
| Current Range of Total "Actual" Pump Flow | 168gpm @ 10psi to 101gpm @ 16psi (763.75lpm @ 69kPa) to 469.16lpm @ 110.4kPa) | 459gpm @ 10psi to 275gpm @ 16psi (2086.66lpm @ 69kPa) to 1250.18lpm @ 110.4kPa) |
| After-Market Pump HP Upgradeability | 4.8 Brake HP (2.5 Continuous-Duty HP) | 9.6 Brake HP (5.0 Continuous-Duty HP) |
| Freeze Protection | Standard | Standard |
| Stereo/CD/Spaside Control/Bose® Speakers | Not Available | Not Available |
| Corona Discharge Ozone Purifier | Optional - Factory Installed | Optional - Factory Installed |
| HO Corona Discharge Ozone Purifier | Not Available | Not Available |
| Underwater Light | Small | Small |
| 24-Bulb LED Lighting System | Optional - Factory Installed | Optional - Factory Installed |
| Filter Element (Top Accessible) | 50 sq. ft. (4.65 sq. m) | 50 sq. ft. (4.65 sq. m) |
| Floor Drain (In Footwell of Spa) | Standard | Standard |
| JetPaks/Headrests | 2 | 3 |
| Seat One - Conventional Jetting | Four Duo-Blaster Jets | Four Duo-Blaster Jets |
| Seat Two - JetPak Model | J06-56-7 | J11-58-5 |
| Seat Three - Conventional Jetting | Four Duo-Blaster Jets | Four Duo-Blaster Jets |
| Seat Four - JetPak Model | J10-22-3 | J06-56-7 |
| Seat Five - JetPak Model | n/a | No Jetting |
| Seat Six - JetPak Model | n/a | J03-63-12 |
| Self-Draining JetPak Feed Lines | Standard w/ Modification | Standard w/ Modification |
| Automatic Filtration in JetPods | Standard | Standard |
| Ozone Jet | 1 | 1 |
| Foot & Leg Jets | 1 | 2 |
| Total Package Jets | 20 | 35 |
| Maximum Aftermarket Jets Available | 36 | 53 |
| Maximum A.M. Jets Available (With Shower Jets) | 217 | 395 |
| Control System | Model 251 | Model 362 |
| Balboa EL Control Box w/ "M7" Technology | Programmable Digital | Programmable Digital |
| Electrical Requirements | 120V~20A or 240V~30/50A | 240V~30/50A |
| Heater (dual overheat protection) | 1.4KW/5.5KW | 5.5KW |
| "Basic" LCD Master Control Pad: | Small Sized, 4-Button, Partially Backlit & Contact Switched features. | Small Sized, 4-Button, Partially Backlit & Contact Switched features. |
| Auxiliary Control Pads | Not Available | Not Available |

*Dry/Maximum Filled Weight" data includes spa cover but no occupants.

Parts Identification Diagrams

Top View of Spa (Model 552 Shown)

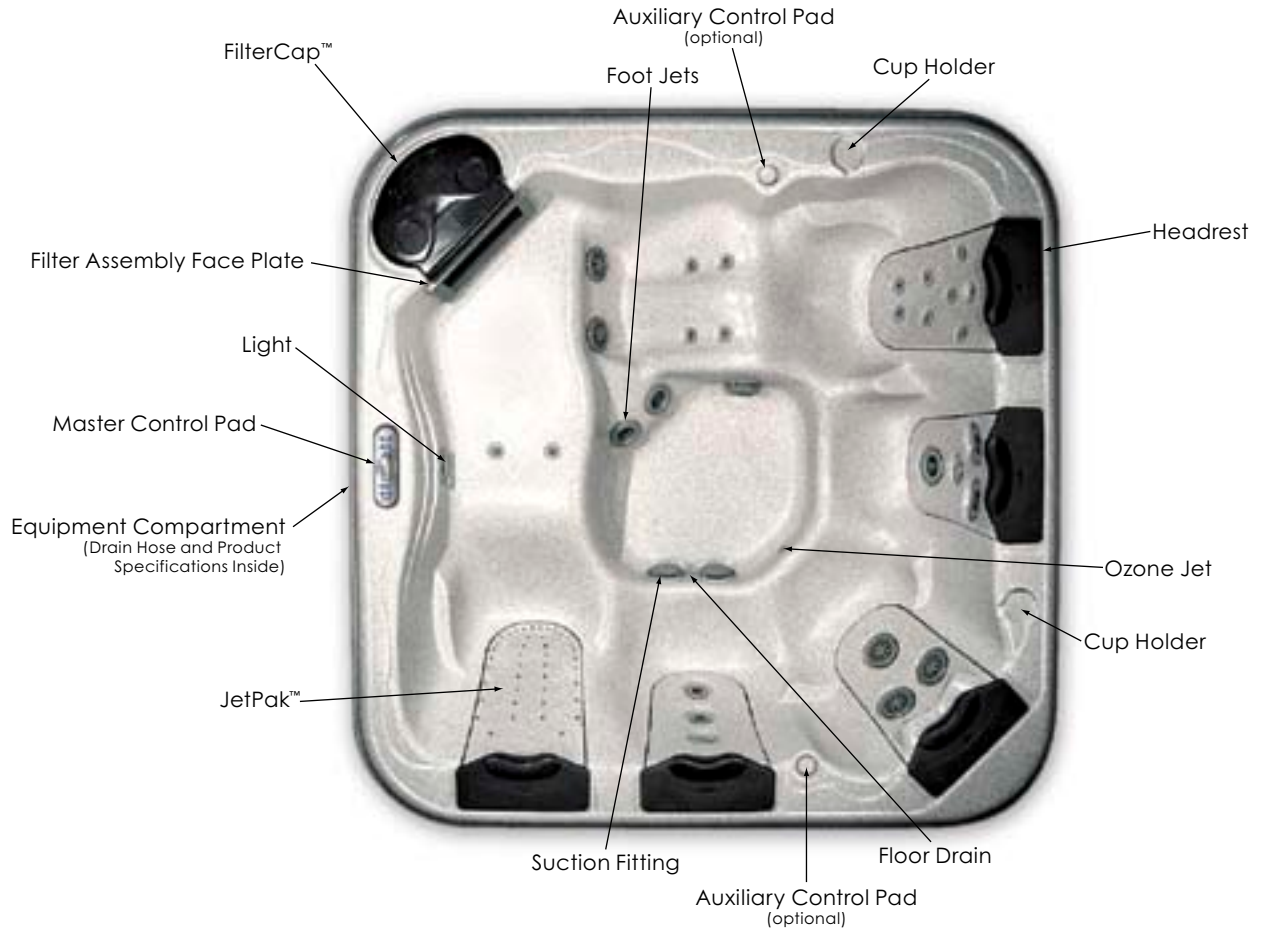

Equipment Compartment

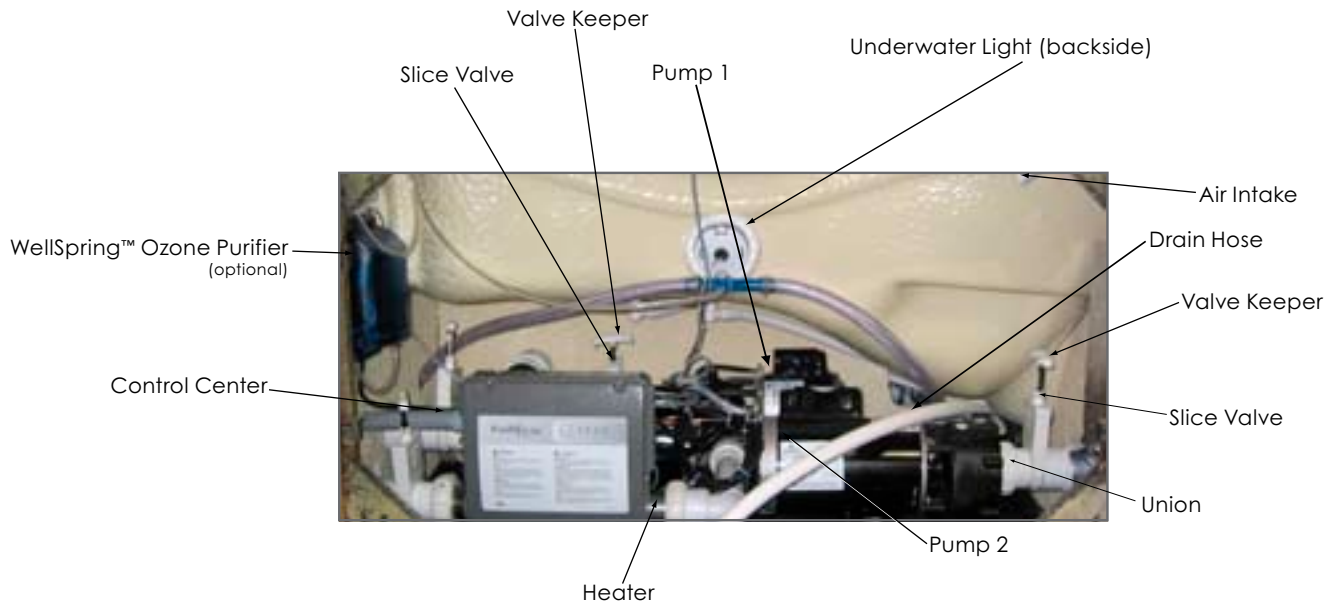

BullfrogTM
INTERNATIONAL, LC

668 West 14600 South
Bluffdale, Utah 84065, USA
801.565.8111
Fax: 801.565.8333

www.bullfrogspas.com
info@bullfrogspas.com

Part #35-1167, Rev. 9/05